



Rajgad Dnyanpeeth's

**SHRI CHHATRAPATI SHIVAJIRAJE COLLEGE OF ENGINEERING**

Gat No. 237, Pune Bangalore Highway, Dhangawadi, Tal – Bhor, Dist- Pune (Maharashtra)

Criterion 5: Student Support & Progression

### 5.3 Student Participation and Activities

**5.3.3. Sports and Cultural events/ competitions organized at the institute level during year.**

#### INDEX

- 1 Lokmanya Tilak Birth Anniversary
- 2 Quiz on Azadi ka Amrut Mahotsav
- 3 Azadi ka Amrut Mahotsav Drawing competition
- 4 Dahihandi
- 5 Constitutional Day & 26.11 Black Day
- 6 Quiz on Rajmat Jijau and Swami Vivekananda Jayanti
- 7 Sports
- 8 Fireless Cooking Competition
- 9 Photography Competition
- 10 Mehendi Competition
- 11 Art Exhibition
- 12 Rangoli Competition
- 13 Mudra
- 14 Rajgad Karandak
- 15 Shivjayanati
- 16 Marathi Bhasha Gaurav Diwas
- 17 Quiz on Mahatma Jyotiba Phule Jayanti
- 18 Quiz on Dr. Babasaheb Ambedkar Jayanti





**Criterion 5: Student Support & Progression**

**Key Indicator- 5.3 Student Participation and Activities**

**5.3.3. Sports and Cultural events/ competitions organized at the institute level during year**

Sr. No.	Activity	Level	Participants
1	Lokmanya Tilak Birth Anniversary	Institute	69
2	Quiz on Azadi ka Amrut Mahotsav	Institute	24
3	Azadi ka Amrut Mahotsav Drawing competition	Institute	21
4	Dahihandi	Institute	All
5	Constitutional Day & 26.11 Black Day	Institute	247
6	Quiz on Rajmat Jijau and Swami Vivekananda Jayanti	Institute	60
7	Sports	Institute	All
8	Fireless Cooking Competition	Institute	50
9	Photography Competition	Institute	10
10	Mehendi Competition	Institute	35
11	Art Exhibition	Institute	14
12	Rangoli Competition	Institute	36
13	Mudra	Institute	All
14	Rajgad Karandak	Institute	All
15	Shivjayanati	Institute	All
16	Marathi Bhasha Gaurav Diwas	Institute	197
17	Quiz on Mahatma Jyotiba Phule Jayanti	Institute	28
18	Quiz on Dr. Babasaheb Ambedkar Jayanti	Institute	34



  
Principal  
Rajgad Dnyanpeeth's  
Shri Chhatrapati Shivajiraje College of Engg.,  
Dhangawadi, Pune-412 205



# 1•Lokmanya Tilak Birth Anniversary

Dear all

Greetings from Rajgad Dnyanpeeth's Shri Chhatrapati Shivajiraje College of Engineering  
Dhangwadi , Pune!!!

\*Department of Library is organizing E-quiz on \*: Lokmanya Tilak Birth Anniversary.\*

\*Link\*: <https://forms.gle/xAj8MRdtNeHESFJX6>

\*The Google form is open from 23 July 2022.\*

◆ Open to all

◆ Please click on the link to participate

◆ \*No registration fee\*

◆ The link will be open until 23 July 2022.

◆ Please, do participate and kindly forward the above mentioned e-quiz information to your  
Friends.

For more information

\* coordinator\*

Mrs. V. D. Dixit

\*Librarian\*

Mr. H. R. Kondagurla

\*Principal\*

Prof. Dr. Patil S. B.

SCSCOE





Rajgad Dnyanpeeth's  
**SHRI CHHATRAPATI SHIVAJIRAJE COLLEGE OF  
ENGINEERING**

S. No. 237, Satara-Pune, NH-4, Dhangawadi, Tal: Bhor, Dist: Pune

**Report on  
"Lokmanya Tilak Birth  
Anniversary."**

**(23 July 2022)**

**Organized By**

**Department of Library**

**In association with**

**RDTTC Polytechnic  
College, Bhor**







Date: 25/07/2022

DEPARTMENT OF LIBRARY

Report on "Lokmanya Tilak Birth Anniversary"

1. **Title of Quiz :** Lokmanya Tilak Birth Anniversary.
2. **Duration:** 23 July 2022
3. **Mode of Conduction :** Online
4. **Link for E-Quiz :** <https://forms.gle/xAj8MRdtNeHESFJX6>
5. **Name of Co-coordinator :** Mrs. V. D. Dixit
6. **Number of Participants:** 69
7. **Objectives:**
  - To build confidence among Indians to speak against the government's suppression.
  - His famous declaration "Swaraj is my birthright, and I shall have it" served as an inspiration for future revolutionaries during India's struggle for freedom.
8. **Description:** In response to the notice given by NDLI by Prof. Dr. S. B. Patil sir suggested conducting the e-quiz on the life of Lokmanya Tilak Birth Anniversary in order to celebrate the birth anniversary. With this proposal, Mrs. V. D. Dixit has prepared the e contest. With the help of Librarian Mr. H. R. Kondagurla. The e-certificate was distributed to all participants. BAL GANGADHAR TILAK BIRTH ANNIVERSARY: INSPIRING QUOTES

If we trace the history of any nation backwards into the past, we come at last to a period of myths and traditions which eventually fade away into impenetrable darkness. It may be providence's will that the cause I represent may prosper more by my suffering than by my remaining free. Swadeshi and swadeshi will be our cry forever and by this, we will grow in spite of the wishes of the ruler. Life is all about a card game.



Choosing the right cards is not in our hand. But playing well with the cards in hand determines our success. The problem is not the lack of resources or capability, but the lack of will. Religion and practical life are not different. To take sanyas (renunciation) is not to abandon life. The real spirit is to make the country, and your family, work together instead of working only on your own. The step beyond is to serve humanity and the next step is to serve God.

9. **Conclusion:** Due to this event, students get aware Lokmanya Tilak was the first leader of the Indian independence movement. The British colonial authorities called him "The father of the Indian unrest". He was also conferred with the title of "Lokmanya", which means "accepted by the people as their leader". Mahatma Gandhi called him "The Maker of Modern India"

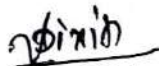

**Mrs.V.D.Dixit**  
Event Coordinator  
(Asst.Librarian)



**Mr.H.R.Kondagurle**  
**LIBRARIAN**  
Shri Chhatrapati Shivajiraje  
College Of Engineering  
Dhangwadi, Tal. Bhor,  
Dist. Pune - 412206



**Dr.S.B.Patil**  
Principal  
Principal  
Raigad Dnyanpeeth's  
Shri Chhatrapati Shivajiraje College of Engg.,  
Dhangawadi, Pune-412206







Rajgad Dnyanpeeth's  
**SHRI CHHATRAPATI SHIVAJIRAJE COLLEGE OF ENGINEERING**

**Department of Library**

Day: Sunday

Date:23/07/2022

Time:11.00am-05.00pm

Title of Program: Event on, " Lokmanya Tilak Birth Anniversary"

**Attendance Sheet**

Sr.NO.	Name	Email	Address	Phone number
1	Aditya Dattatray Ingale	adityaingale73@gmail.com	Shirwal	7057119995
2	Prasad Vijay mandhare	prasadmandhare458@gmail.com	A.p varodi kh. tal .BHOR.dist	7888148042
3	Ghone vaishnavi	vaishnavighone2005@gmail.com	At.post qathar colony	8237947831
4	vaishnavi Ramesh Sutar	sutarvasiahnavi2022@gmail.com	Sarola.tal .bhor,dist.pune	9890156690
5	Ishwari Rahul Samgir	ishwarisamgir@gmail.com	At.post Sarola Tal. Bhor Dist.	7020091967
6	Saniya Nisar Attar	saniyaattar313@gmail.com	Shirwal	8140565857
7	Ganesh kank	kankganesh021@gmail.com	mhasar kh	7620470041
8	Riya Yogesh Mistri	riyayogeshmistri@gmail.com	Shirwal,Kamala Nagar.	9175936780
9	Pranay vijay jedhe	pranayjedhe6201@gmail.com	At.post kari,tal.bhor,dist.pune	7020934762
10	Miss.Thorave Sonali M	sonalithorave5073@gmail.com	A/P Vyahali Colony Tal-wai d	9822571542
11	Asmita funde	fundeasmita1611@gmail.com	Mira society building no. 11	9579394955
12	Kisave Akash Shivaji	akashkisave605@gmail.com	At hastanpur,post Bijawad	7083849043
13	Janhvee salunkhe	janhveesalunkhe74@gmail.com	Bharati vidyapeet pune	9371703704
14	Parth	prabhulkarparth@gmail.com	Shirwal	9834936471
15	Rishikesh Shaifesh Gujar	hrushigujar08@gmail.com	574 bhoiali bhor ta.bhor di. P	9396160213
16	D K Khopade	dkkhopade111@gmail.com	Bhor	7972420342
17	Pranav Thopte	pranavthopte412@gmail.com	At-hatmoshi tal-Bhor dist-pune	9511674976
18	Deepika	deepikananawarej@gmail.com	At utroli	9850110417
19	Vaishnavi chaudhari	chaudharibalu760@gmail.com	Varve bk	8796642540
20	Snehal Ashok pilane	snehalpilan@gmail.com	Veer	9322418047
21	Sanika sanjay Talekar	sanikatalekar629@gmail.com	At post Kapurhol tal bhor dist	7378905104
22	Nikita prashant guldaga	nikitaguldagad48@gmail.com	At post veer tal purandar dist	9960584804
23	Sachin babarao kute	sachinkute713@gmail.com	Nasrapur	8766637501
24	Vedant Vilas Wagh	vedantwagh9011@gmail.com	Shirwal	8149774020
25	Pooja	poojadilipgaikwad3226@gmail.com	At-wathar hinge. Post-taperv	7496605550
26	Aditi Yadav	aditiy341@gmail.com	At kesurdi ,tal khandala , dist	8799817171
27	Rushikesh Mahadev Thorave	rushikeshthorave386@gmail.com	A/p Vyahali Colony T-Wai Dis	8857922496
28	Vaishnavi Baburao Mangaraj	rohanmangade15@gmail.com	At mangadanj ,post kolwadi, t	9146873162



850110417

86142540

82418047

78905104

980584804

908637501



29	Shrutika Dinesh Lokha	shrutikalokhande252@gmail.com	At - Malwadi Tal - Bhore D - P	7820861063
30	Hrutik Sunil Yedave	rutikyedave@gmail.com	At .post utroli	8261943818
31	Namrata Santosh Sond	sondkarnamrata2@gmail.com	AT post varve Bk.Tal-Bhor D	8237925447
32	Deepali vilas veer	priyankaveer62@gmail.com	Shirwal	08530706087
33	ALGUDE SANIKA SAN	sanikaalgude24@gmail.com	Navi Ali, Bhor	8275960639
34	Shedage Vaishnavi Aa	vaishnavishedage91@gmail.com	308 Bajrang aali bhor	9623542180
35	Madhavi Dongargave	madhavidongargave@gmail.com	Siddhivinayak Society Jambh	8766566307
36	Himakar	khimakar92@gmail.com	Dhangwadi	09405092611
37	Vinay Santosh Jadhav	vinayjadhav476@gmail.com	Shirwal	7218666896
38	Akshya	aj559174@gmail.com	Phaltan	8625037320
39	Charushila Raju Ransh	charuranshur1011@gmail.com	Yawat	9146991231
40	Rohit Santosh Kinhale	rohitkinhale@gmail.com	At.post karnwadi tal.khandala	8010229439
41	JAGTAP SARTHAK	jagtapsarthak2004@gmail.com	At-Post Mandbar Tal-Purand	8805883573
42	Payal Gaikwad	payaldilipgaikwad1211200	Hinge wathar	8010782723
43	Viraj tikonkar	virajtikonkar0@gmail.com	Wadgav tal,khandala dist,sa	7875430550
44	Sonali sahebrao gole	golesonali94@gmail.com	At narhe tal bhor dist pune	08468846090
45	MAZAHMED MOHDAY	maazkhan9022@gmail.com	Shirwal	9022500189
46	Bhosale Ankita Ramch	shreyabhosale2003@gmail.com	At post- ajnuj Tal- Khandala	09562208243
47	Sanjeevani Vitthal Tam	sanjeevanitambe08@gmail.com	At Post Shirwal , Tal-khandal	7972710117
48	Shivani Sanas	Shivani801019@gmail.com	At anandpur, post.chandak,ta	08010197017
49	Pooja Mahadev. Deshm	queenpooja.m.2004@gmail.com	Dasturi naka,sayli complex,sa	7385988761
50	Snehal Nilesh patekar	snehalpatekar29@gmail.com	At.post. shirwal tal khandala	8421182954
51	Nisha mahangare	nishamahangare4@gmail.com	At.post. wing,tel-khandala ,di	8010628124
52	Vaishnavi ASHOK Bod	poonambodare649@gmail.com	Alande ta bhor district pune	7219609648
53	Kanishka Khopade	kanishkakhopade07@gmail.com	Swapnalok Nagri Bhor	9881692769
54	Sakshi parbal	sakshinparbal2004@gmail.com	At post bhongawali tal bhor d	9322826402
55	Kamble sakshi jayram	kamblesakshi901@gmail.com	At.Post-Wather Colony,Tal-K	8482974057
56	Salunkhe apurva vidya	apurvasalunkhe04@gmail.com	Wathar bk	7756063283
57	Adhiraj Nalawade	adhirajnalawade8525@gmail.com	Kapurhol	8007753666
58	Pratiksha Popat Choud	pratiksha767@gmail.com	AT-Choudharwadi. Post-Hard	8080099377
59	Maithili rajendra pawar	maithilipawar.wai@gmail.com	At warkhdwadi post bhogaon	9673288698
60	Sanket satish Mandhar	mandharesanket510@gmail.com	Mirjewadi,tal Khandala Dist S	9022702166
61	Omkar Ganpat. Shinde	omkarshinde3187@gmail.com	A/P Malewadi Mahude Kh. T	9769628908
62	Madhav Vedpathak	madhavve2@gmail.com	76/613, Laxminagar Parvati P	9763031538





63	Pritam Suresh Bhargude	pritamabhargude9604@gr	Palashi tal Khandala dist Sat	8766664607
64	Shivani Rajendra Nalav	rajendranalawade084@gr	At post Shindewadi Tal -Khar	8208319366
65	Pilane Chaitali Machind	chaitalipilane@gmail.com	At/post -lapatalwadi tal-purand	9022013305
66	Pragati dhaigude	pragatidhayagude@gmail	Andori	8010595366
67	Tanvi Mane	manetanvi2117@gmail.co	At. Post tal,Khandala. Dist Sa	7507816815
68	Ankit Jawale	ankitjawale29aj@gmail.co	Kalachowki,lalbaug,mumbai	8451917600
69	SHUBHAM dattatray kl	khomneshubham115@gr	At post kenjal bhor pune	9067654150



8766664607  
 8208319366  
 9022013305  
 8010595366  
 7507816815  
 8451917600  
 9067654150

8766664607  
 8208319366  
 9022013305  
 8010595366  
 7507816815  
 8451917600  
 9067654150

## 2•Quiz on Azadi ka Amrut Mahotsav



RajgadDnyanpeeth's  
**SHRI CHHATRAPATI SHIVAJIRAJE COLLEGE OF ENGINEERING**  
S. No. 237, Satara-Pune, NH-4, Dhangawadi, Tal: Bhor, Dist: Pune

### DEPARTMENT OF LIBRARY

Notice on Social Media

Date: 11 Aug. 2022.

Greetings to all.....!!

Greetings from RD's Rajgad Dnyanpeeth Technical Campus (Engineering Degree & Polytechnic) Dhangawadi , Pune!!!

RD's Rajgad Dnyanpeeth Technical Campus is organising Quiz Competition on the occasion of 75th Anniversary of Indian Independence or Azadi Ka Amrit Mahotsav

Link- <https://forms.gle/Jhn71gUbfKiayQb79>

- ◆ Open to all
- ◆ Please click on the link to participate
- ◆ No registration fee
- ◆ Please, do participate and kindly forward the above mentioned Participation information to your Friends.

For more information

\* coordinator\*  
Prof. Shaikh T. A.  
( RDTC, POLY)  
Prof. Kondagurla H.R.  
( RD's SCSCOE)

Principal  
Prof. Khopade D.K.  
(RDTC POLY)

Principal  
Prof. Dr. S. B. Patil  
(RD's SCSCOE)

Website: [www.rajgad.edu.in](http://www.rajgad.edu.in)







Rajgad Dnyanpeeth's  
**SHRI CHHATRAPATI SHIVAJIRAJE COLLEGE OF  
ENGINEERING**

S. No. 237, Satara-Pune, NH-4, Dhangawadi, Tal: Bhor, Dist: Pune

**Report on  
"75 Azadi ka AmrutMahotsav-  
Quiz Competition."**

**(12 August 2022)**

**Organized By**

**Department of Library**

**In association with**

**RDTC Polytechnic  
College, Bhor**





**DEPARTMENT OF LIBRARY**

**Report on "75 AzadikaAmrutMahotsav-Quiz Competition."**

- 1. Program type:** Activity
- 2. Event Name:** "75 AzadikaAmrutMahotsav- Quiz Competition."
- 3. Event coordinator:** Prof. Kondagurla H. R. & Prof. Shaikh T. A.
- 4. DATE of Event:** Friday, 12/08/2022.
- 5. Duration of Event:** 11.00am- 05.00pm
- 6. Venue of event / Link:** <https://forms.gle/Jhn71gUbfKiayQb79>
- 7. STUDENT :** 24

**8. OBJECTIVE:**

Azadi Ka Amrit Mahotsav to encourage people to bring the Tiranga home and to hoist it to mark the 75th year of India's independence. Our relationship with the flag has always been more formal and institutional than personal. Bringing the flag home collectively as a nation in the 75th year of independence thus becomes symbolic of not only an act of personal connection to the Tiranga but also an embodiment of our commitment to nation-building.

**9. Description (program conduction details) / speaker topic explanation:**

The Government of India decided to celebrate the 75 years of Independence of India, with great excitement and tribute to freedom fighters. So, they decided to do various programs and the government named the celebration as 'AzadiKaAmritMahotsav'





## 10. Conclusion:

The Har Ghar Tiranga campaign would help to instill patriotism and nationalism in Indian citizens. It is also a good method to demonstrate our national commitment. As a result, our national flag will be held in higher regard. This campaign would also serve to remind Indian citizens of their duty to the country.



Mr. H. R. Kondagurla

**LIBRARIAN**  
Shri Chhatrapati Shivajiraje  
College Of Engineering  
Dhangwadi, Tal. Bor,  
Dist. Pune - 412206



Prof. Dr. S. B. Patil

**Principal**  
Rajgad Dnyanpeeth's  
Shri Chhatrapati Shivajiraje College of Engg.,  
Dhangwadi, Pune-412206

# आझादी का 75 अमृतमहोत्सव ( हर घर तिरंगा) Quiz Competition

\* Required

1. Name \*

2. Address \*

3. Phone number \*

4. College Name \*





5. Class \*

Check all that apply.

- Diploma
- Engineering
- 10th
- 11th
- 12th
- 9th

**आझादी का 75 अमृतमहोत्सव ( हर घर तिरंगा) Quiz Competition**

6. 1) What was the another name of 'Quit India movement'?

Mark only one oval.

- Khilafat Movement
- Swadeshi Movement
- Home Rule Movement
- August Kranti

7. 2) Who was the first prime minister of India? \*

Mark only one oval.

- Mahatma Gandhi
- Pandit Jawahar Lal Nehru
- Subhash Chandra Bose
- Aurobindo Ghosh



8. 3) Who set up the Indian Independence League in 1942? \*

Mark only one oval.

- Rash Bihari Bose
- Anand Charlu
- Bipin Chandra Pal
- Madan Mohan Malviya

9. 4) Who gave the slogan Give me blood and I promise you freedom?

Mark only one oval.

- Subhash Chandra Bose
- Vinayak Samodar Savarkar
- Jawaharlal Nehru
- Mahatma Gandhi

10. 5) who is called the father of the nation ?

Mark only one oval.

- Jawaharlal Nehru
- Mahatma Gandhi
- Subhash Chandra Bose
- Sardar Vallabh Bhai Patel





11. 6) Who was the first President of India?

Mark only one oval.

- Dadabhai Naoroji
- Kashinath Trimbak Telang
- Dr. Rajendra Prasad
- Surendranath Banerjee

12. 7) Who gave the slogan "Sarfaroshi ki Tamanna ab hamare dil mein hai" ?

Mark only one oval.

- Ramprasad Bismil
- Vinayak Samodar Savarkar
- Jawaharlal Nehru
- Mahatma Gandhi

13. 8) The Muslim League demanded a separate state for the Muslims in the year :

Mark only one oval.

- 1920
- 1930
- 1940
- 1946

14. 9) How many days did it take the satyagrahis to reach Dandi? \*

Mark only one oval.

- 21
- 25
- 15
- 24

15. 10) On which date did Gandhiji and his followers reach Dandi? \*

Mark only one oval.

- 5 April 1930
- 5 April 1931
- 5 May 1932
- 15 April 1930

16. 11) When was the 'Quit India Movement' Launched by Mohandas Karamchand Gandhi? \*

Mark only one oval.

- 1946
- 1939
- 1942
- 1940





17. 12) What were the words of Mrs. Sarojini Naidu when Gandhi broke the salt law? \*

Mark only one oval.

- Brave Step
- Well done
- Hail Deliverer
- We are Indian

18. 13) Who founded the All India Harijan Samaj in 1932? \*

Mark only one oval.

- Lala Lajpat Rai
- Subhash Chandra Bose
- Jawaharlal Nehru
- Mahatma Gandhi

19. 14) Why did Mountbatten choose the day- August 15? \*

Mark only one oval.

- Commemorate V-E Day - collapse of the Nazi rule in Berlin
- Commemorate the U.K.'s takeover of the administration of Lebanon and Syria
- Commemorate the second anniversary of Japan's surrender to the Allied Forces
- Commemorate the demobilization of the wartime armed forces

20. 15) Who amended its constitution and declared Goa as its state after India's independence but was unsuccessful?

Mark only one oval.

- Portuguese
- Dutch
- English
- Danes



This content is neither created nor endorsed by Google.

Google Forms





Rajgad Dnyanpeeth's  
**SHRI CHHATRAPATI SHIVAJIRAJE COLLEGE OF ENGINEERING**  
S. No. 237, Satara-Pune, NH-4, Dhangawadi, Tal: Bhore, Dist: Pune

**Department of Library**

Date: 12/08/2022

Time: 11.00am-05.00pm

Day: Friday

Title of Program: Event on " 75 AzadikaAmrutMahotsav-Quiz Competition."

Sr. No.	Name	Address	Phone number	College Name
1	Miss.Thorave Sonali Mahadev	A/P Vyahali Colony Tal-wai dist -satara	9822571542	SCSCOE
2	Akshada Gorad	At post Sangamner, Taluka-Bhor, Dist-Pune	7558643495	Rajgad Dynanpeet Technical Campus
3	Madhura nitin mandhare	Murum	9699728123	New english school murum
4	Sanket Bhoite	Lonand, Tal :- Khandala, Dist :- Satara	9890631862	Shri Chhatrapati ShivajiRaje College Of Engineering
5	Vaishnavi Pandurang Popale	Priydarshini Girls Hostel Bhor	96898 71200	Technical Campus Shri Chatrpati Shivajiraje College
6	Jagtap jay ramdas	At post murum tel- baramati dist-pune	8767121557	New English school murum
7	Tamanna	Pune	1536	Rajgad
8	Khopade Pratiksha Deepak	At-Post-Ambade Tal-Bhor Dist-Pune Pin no. 412206	9604543469	Chhatrapati Shivajiraje College Of Engineering
9	Sufiya jamir Patel	M .p. kanheri. T. Khandala d. Satara	7798760946	Sri samarth Vidya Mandir kaneri
10	Adarsh Shinde	A/p Shirwal, Tal. Khandala, Dist. Satara.	9767433652	RDTC SCSCOE
11	पियुष अशोक वीर	वाघजाईनगर भोर	98822940820	विद्यालय व ज्यु कॉलेज खानापुर ता. भोर
12	Jiya Jahangir Inamdar	Murum tel Baramati dist pune	9730187863	New English school Murum
13	T M Dudhane	RDs, SCSCOE, Dhangawadi, Tal. Bhor, Dist. Pune.	9922341662	SCSCOE, Dhangawadi, Tal. Bhor, Dist. Pune.
14	Bhagwan Dinkar Thorat	Pune	9881290300	Technical Campus Shri Chhatrapati Shivajiraje
15	Sujal kirve		8208844833	8208844833
16	Shubham Sudesh patil	Dhumalnager bhor	7666710451	Shri Chatrapati Shivajiraje college of engineering
17	चेतन राम पवार	म. पो. पाबे, ता. वेल्हे, जि. पुणे	7972322905	तानाजी मालुसरे विद्यालय दापोडे
18	Prajakta Ganpat Renuse	At post pabe tel velhe dist pune	8766791559	Tanaji malusare vidyalay Dapode
19	Prasad Vijay Mandhare	AP. varodi kh. Tal bhor .dist pune	7888148042	Rajgad dnyanpeeth technical campus dhangawadi
20	Hrutik Sunil Yedave	At. Post. Utroli	8261943818	RDTC
21	Pooja dilip gaikwad	taparewadi, tal- bhor ,dist-pune	7498605550	Rajgad dyanpeeth technical campus
22	Xyz	Dhangwadi	7987654327	Rdte
23	Sanchit Sanjay Khandalkar	At veerwadi post jambhli tal bhor dist pune	9373220205	Rajgad dnyanpeeth technical campus
24	Payal pradip vaidya	At post dapode tel vehale jhala Pune	9322702713	Tanaji malusarr Vidyalaya dapode





# 3•Azadi ka Amrut Mahotsav Drawing competition



Rajgad Dnyanpeeth  
**RAJGAD DNYANPEETH TECHNICAL CAMPUS**  
(DEGREE ENGINEERING & POLYTECHNIC)  
S.N. NO. 237, Dhimgawadi, Tal. Bhor, Dist. Pune - 412205

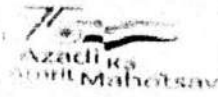

## Notice

Date : 02/08/2022

### DRAWING COMPETITION

All the students are informed that we are organizing "Swarajya Amrit Mahotsav" and "Har Ghar Tiranga" event in our college campus from 11<sup>th</sup> August to 17<sup>th</sup> August for students. However, everyone should participate enthusiastically in Drawing competition.

#### • Subjects for Drawing Competition :

- Aatm Nirbhar Bharat
- Majha Tiranga Majhi Shan
- Jai Jawan Jai Kisan
- Satyamev Jayate

#### • Drawing Competition Rules

- Contest will start on Saturday, 12<sup>th</sup> August 2022 at 11 AM.
- The competition will be held from 11:00 to 2:00 in Library Reading Hall within the stipulated time.
- The drawings should be made on an only Art paper.
- A certificate of participation will be issued after the completion of the competition.
- Winner and Runner-up get the Good Price.

Sr.No	Name of Staff	Contact No.	Sign
1.	Prof. Tanpure S.S.(Coordinator Diploma)	9049512021	
2.	Prof. Bohade A.R.(Coordinator Degree)	8796170172	

Prof. P.S. Kedge  
Event Co-ordinator  
(RDTC, Poly)

Prof. L. M. Sagate  
Event Co-ordinator  
(SCSCOE)

Prof. T.N. Dudhane  
NSS Officer  
(SCSCOE)

Prof. D.K. Khopkar  
Principal  
(RDTC, Poly)

Prof. S.B. Paul  
Principal  
(SCSCOE)





Rajgad Dnyanpeeth's  
**SHRI CHHATRAPATI SHIVAJIRAJE COLLEGE OF  
ENGINEERING**

S. No. 237, Satara-Pune, NH-4, Dhangawadi, Tal: Bhore, Dist: Pune

**Report on  
"75 Azadi ka AmrutMahotsav-  
Drawing Competition."**

**(13 August 2022)**

Organized By

**Department of Library**

In association with

**RDTC Polytechnic  
College, Bhore**





Rajgad Dnyanpeeth's

**SHRI CHHATRAPATI SHIVAJIRAJE COLLEGE OF ENGINEERING**  
Gat No. 237, Pune Bangalore Highway, Dhangawadi, Tal – Bhor, Dist- Pune (Maharashtra)

## DEPARTMENT OF LIBRARY

### Report on "75 AzadikaAmrutMahotsav-Drawing Competition."

1. **Program type:** Activity
2. **Event Name:** "75 AzadikaAmrutMahotsav-Drawing Competition."
3. **Event coordinator:** Prof.Bobade A.R. and Prof. S.S.Tanpure.
4. **DATE of Event:** Saturday , 13/08/2022.
5. **Duration of Event:** 11.00am- 02.00pm
6. **Venue of event / Link:** Library Reading Hall, Dhangawadi
7. **STUDENT :** 21

#### 8. OBJECTIVE:

Azadi Ka Amrit Mahotsav to encourage people to bring the Tiranga home and to hoist it to mark the 75th year of India's independence. Our relationship with the flag has always been more formal and institutional than personal. Bringing the flag home collectively as a nation in the 75th year of independence thus becomes symbolic of not only an act of personal connection to the Tiranga but also an embodiment of our commitment to nation-building.

#### 9. Description (program conduction details) / speaker topic explanation:

The Government of India decided to celebrate the 75 years of Independence of India, with great excitement and tribute to freedom fighters. So, they decided to do various programs and the government named the celebration as 'AzadiKaAmritMahotsav'





## 10. Conclusion:

The Har Ghar Tiranga campaign would help to instill patriotism and nationalism in Indian citizens. It is also a good method to demonstrate our national commitment. As a result, our national flag will be held in higher regard. This campaign would also serve to remind Indian citizens of their duty to the country.

## 11. Photo with Caption:



Photo.1-Drawing Competition of "HarGharTiranga"



Photo.2-Azadi ka Amrut Mahotsav HarGharTiranga Competition





Photo.3- Students Present for 75 Amrut Mahotsav With Posters



Photo.4- Principals, All HOD's and Students

*H.R.M.*

Mr. H. R. Kondagurla  
**LIBRARIAN**  
 Shri Chhatrapati Shivajiraje  
 College Of Engineering  
 Dhangwadi, Tal. Ehor,  
 Dist. Pune - 412206



*S.B.P.*

Prof. Dr. S. B. Patil

**Principal**  
**Principal**  
 Rajgad Dnyanpeeth's  
 Shri Chhatrapati Shivajiraje College of Engg.,  
 Dhangawadi, Pune-412206





Rajgad Dnyanpeeth's  
**SHRI CHHATRAPATI SHIVAJIRAJE COLLEGE OF ENGINEERING**  
Gat No. 237, Pune Bangalore Highway, Dhangawadi, Tal – Bhor, Dist- Pune (Maharashtra)

## Dahi-Handi - 2022

**DEPARTMENT:** All

**TITLE/TOPIC:** Dahi-Handi - 2022

**DAY & DATE:** Monday, 22/08/2022

**DURATION OF EVENT:** 02.00 pm to 05.00 pm.

**STUDENT/STAFF PRESENT:** 600/75

**CO-ORDINATOR:** Prof. K. S. Khamkar

Prof. K. R. Juare

**OBJECTIVE:** Dahi Handi is a Hindu festival which is celebrated with great enthusiasm and fervor on the second day of Janmashtami. This is a sporting event organized across the cities especially in Maharashtra.

### DESCRIPTION:

On Friday, 22nd August 2022, Rajgad Dnyanpeeth's Technical Campus had organized "DAHI-HANDI CELEBRATION", where students participated the celebration enthusiastically. The students of various branches selected their best team for dahi-handi.

The students were overjoyed when they broke the 'Dahi Handi' (pot of butter & curd) to grace this occasion. Dahi Handi is the most ancient joyful game played and celebrated, for the birth of Krishna in Janmashtami. It is celebrated amidst merriment. A competition was organized as each department boys gathered to form teams, make a human pyramid and attempt to reach or break the pot, whichever team does it in minimum time wins it.



Dahihandi - 2022

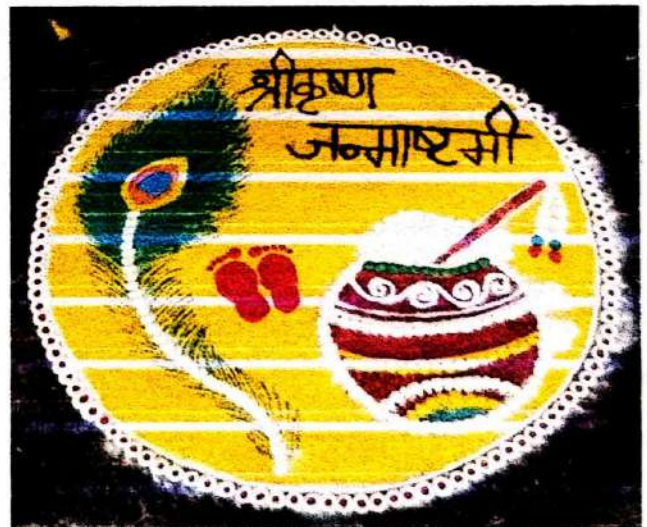

Event Rangoli





**Girls Team**



**Boys Team**

*K. S. Khamkar*

Prof. K. S. Khamkar, Prof. K. R. Juare  
Cultural Coordinator



*S. B. Patil*

Prof. Dr. S. B. Patil  
Principal

**Principal**

Rajgad Dnyanpeeth's  
Shivajiraje College of Engg  
Anangawadi, Bhor, Pune-412206



# 5•Constitutional Day & 26.11 Black Day



RajgadDnyanpeeth's  
**SHRI CHHATRAPATI SHIVAJIRAJE COLLEGE OF ENGINEERING**  
Gat No. 237, Pune Bangalore Highway, Dhangawadi, Tal - Bhore, Dist- Pune (MH)

Date:-24/11/2022

## NOTICE

All students, teaching staff and non-teaching staff are hereby informed that, on the occasion of, "Constitutional days or Sanvidhan Diwas" and "26/11 Black day", we are organizing reading of Preamble of the constitution and give tribute to the national soldier (26/11 Black day) for 2 min on 26/11/2022 at 4.30 pm in college ground.

All are requested to assemble on time.

*Bombale*

Mr. H. R. Kondagurla  
**LIBRARIAN**  
Shri Chhatrapati Shivajiraje  
College Of Engineering  
Dhangwadi, Tal. Bhore,  
Dist. Pune - 412206

*Kondhalkar*

Prof. A.K.Kondhalkar  
**Principal**  
Rajgad Dnyanpeeth's  
Rajgad Junior College of Science  
Dhangawadi, Tal-Bhore, Dist-Pune-412206

*Khopade*

Prof. D. K. Khopade  
**Principal,**  
RDTCP

*Patil*

Prof. Dr. S. B. Patil  
**Principal,**  
SCSCOE

Copy to : Degree

All Notice Borad

Mechanical HoD

Civil HoD

Computer HoD

E& Tc HoD

First Year HoD

*Patil*

*Patil*

*Patil*

*Patil*

Copy to : Diploma

Mechanical HoD

Civil HoD

Computer HoD

E& Tc HoD

First Year HoD

*Patil*

*Patil*

*Patil*

*Patil*

*Patil*

Jr. College

HOD *Patil*

Mrs. Tanpure S.S.

**LIBRARIAN**

RAJGAD DNYANPEETH TECHNICAL  
CAMPUS, POLYTECHNIC  
Dhangawadi, Tal. Bhore,  
Dist. Pune. 412 206



Rajgad Dnyanpeeth's  
**SHRI CHHATRAPATI SHIVAJIRAJE COLLEGE OF  
ENGINEERING**

S. No. 237, Satara-Pune, NH-4, Dhangawadi, Tal: Bhor, Dist: Pune

**Report on  
"Constitutional Day" and  
"26/11 Black day."**

**(26 November 2022)**

**Organized By**

**Department of Library**

**In association with**

**RDTC Polytechnic  
College, Bhor**







## DEPARTMENT OF LIBRARY

### Report on "Constitutional Day" and "26/11 Black day."

- 1. Program type:** Activity
- 2. Event Name:** "Constitutional Day" and "26/11 Black day."
- 3. Event coordinator:** Mr. H. R. Kondagurla
- 4. DATE of Event:** Saturday, 26<sup>th</sup> November 2022
- 5. Duration of Event:** 4.00 pm to 5.00 pm.
- 6. Venue of event / Link:** Ground, RD's SCSCOE, Dhangawadi
- 7. STUDENT :** 247

**STAFF PRESENT:** 35

### 8. OBJECTIVE:

- ❖ To create awareness in the young minds regarding the Constitution of India and give tribute to National Soldier.

### 9. Description (program conduction details) / speaker topic explanation:

On the occasion of "Constitutional days ( Samvidhan Diwas)" and "26/11 Black day", Library organized reading of Preamble and give tribute to the National Soldier at the College ground on Friday 26th Nov 2022 at 4.00 pm to 05.00 pm. The photo of Dr. Babasaheb Ambedkar was garlanded by Prof. Dr. S B. Patil Principal (scscoe), Prof. D. K. Khopade , Principal (RDTCP), Mr. R.S. Khamkar (Estate Manager). Prof. S. A. Upadhye. HOD (Mechanical, RDTCP ) read the Indian Constitution and told the importance of it.

The Constitution of India is the supreme law of India. The document lays down the framework that demarcates fundamental political code, structure, procedures, powers, and duties of government institutions and sets out fundamental rights, directive principles, and the duties of citizen.



After that, tributes were paid to the soldiers who were martyred on 26/11.

### 10. Conclusion:

The speaker concluded that Samvidhan Divas aims at highlighting the significance of the Indian constitution and to spread thoughts and ideas of Dr. B.R Ambedkar. After that, tributes were paid to the soldiers who were martyred on 26/11.

### 11. Photo with Caption:



Photo: Worship







Oath Ceremony



Participation of Students



Participation of Staff







26/11 Black Day Poster

Mr. H. R. Kondagurla  
**LIBRARIAN**  
Shri Chhatrapati Shivajiraje  
College Of Engineering  
Dhangwadi, Tal. Bhor,  
Dist. Pune - 412206



Prof. Dr. S. B. Patil

**Principal**  
**Principal**  
Rajgad Dnyanpeeth's  
Shri Chhatrapati Shivajiraje College of Engg.,  
Dhangawadi, Pune-412206





Department of Library

Day: Saturday

Date: 26/11/2022

Time: 04.00pm-05.00pm

Title of Program: Event on, " Constitutional Day" and "26/11 Black day "

Attendance Sheet

Sr. No.	Full Name	Department	Mobile No.	Sign
1	Sutan Aniket Ulkar	BE Mech	9096839059	<u>Sutan</u>
2	Kandhalkar Shubham	BE Mech	7218707579	<u>Shubham</u>
3	Nalawade Prasad P.	BE mech	9163930779	<u>Prasad</u>
4	Harihar Kiran D.	BE mech.	9762009177	<u>Harihar</u>
5	Chavan Dnyanraj P.	BE mech	7447813210	<u>D.P. Chav</u>
6	Yadav Karan S.	BE mech	9021969769	<u>Karan</u>
7	Walhekar Mayur N	BE mech	9172373919	<u>Mayur</u>
8	Pednekar Aakor .C.	BE. mech	7875078963	<u>Aakor</u>
9	Kadam Vaishnavi P.	BE Mech	8208770703	<u>Kadam</u>
10	Patil Ritesh S.	FE Comp	7219409438	<u>Ritesh P</u>
11	Mayur Chakvate	F.E computer	9657051437	<u>Chakvate</u>
12	Kashid Vaishnavi	S.E. comp.	9922159319	<u>Vaishnavi</u>
13	Popale Vaishnavi	SE. comp	9689871200	<u>Vaishnavi</u>
14	Sneha Uppaebawde	SE. comp.	7972795527	<u>Sneha</u>
15	Abhaya Sandkar	11 <sup>th</sup> Sci	7378336003	<u>A. Sandkar</u>
16	Sarthak Raut	11 <sup>th</sup> sci	7276777365	<u>Sarthak</u>
17	Vaibhav Sapkal	11 <sup>th</sup> sci	9766737677	<u>Vaibhav</u>
18	Anjaneyan Panikar	11 <sup>th</sup> sci	9028781312	<u>Anjaneyan</u>
19	Harshad Walhekar	11 <sup>th</sup> sci	9028458652	<u>Harshad</u>





20	Chonghe vijay sandip	11 <sup>th</sup> science	9767716207	<u>Chonghe</u>
21	Karan Rajendra thosale	11 <sup>th</sup> science	9971252984	<u>Rajan</u>
22	Aditya Ramesh chavan	11 <sup>th</sup> science	9767014330	<u>Aditya</u>
23	Aditya santosh shivatane	11 <sup>th</sup> science	9511609942	<u>A.S. Shivatane</u>
24	sandesh santosh jadhav	11 <sup>th</sup> science	8007615602	<u>S. Jadhav</u>
25	Anuj Ashok Jagtap	11 <sup>th</sup> science	9822492601	<u>Anuj</u>
26	Velay Tanajishinde	11 <sup>th</sup> science	8806960189	<u>Velay</u>
27	Chetan Ramesh Jumele	11 <sup>th</sup> science	9970687562	<u>Chetan</u>
28	Atharva Netaji pathade	11 <sup>th</sup> science	8087440618	<u>A.M. Pathade</u>
29	Mayur Sanjay petkar	11 <sup>th</sup> science	8237127052	<u>M.S. Petkar</u>
30	Dhamal Sahil Deepak	11 <sup>th</sup> Science	9021911549	<u>S.D. Dhamal</u>
31	Pawar Yash Arun	11 <sup>th</sup> Science	8600862744	<u>Yash</u>
32	Aayash Arjun Mandhare	11 <sup>th</sup> science	7557572112	<u>Aayash</u>
33	Kiron Vishnu chavan	11 <sup>th</sup> science	9588269747	<u>Kiron</u>
34	Yash Prafulla Ahire	11 <sup>th</sup> science	9359077562	<u>Yash</u>
35	Dhiraj Pramod Bobade	11 <sup>th</sup> science	9552492913	<u>Bobade</u>
36	Shrikant vikas more	11 <sup>th</sup> science	7798827615	<u>S.V. More</u>
37	Atharv Santosh Bhargude	11 <sup>th</sup> science	7058773718	<u>A.S. Bhargude</u>
38	Pranav Rajendra more	11 <sup>th</sup> science	9156135205	<u>Pranav</u>
39	Siddhesh Pandurang Balle	11 <sup>th</sup> science	7249700772	<u>S.P. Balle</u>
40	Sarthak Ashok chavan	11 <sup>th</sup> Science	7276308996	<u>S.A. chavan</u>
41	Vedant Rajesh kakade	11 <sup>th</sup> Science	7058109779	<u>Vedant</u>
42	Aryan Bhagawan bobak	11 <sup>th</sup> Science	9923585473	<u>Aryan</u>
43	Dipak Ramesh Ghatge	11 <sup>th</sup> sci	9685547267	<u>Dipak</u>
44	Ayan Jamis Shaikh	11 <sup>th</sup> sci	9922283045	<u>A.J. Shaikh</u>





45	Grade sarthak Awards	11th sci	9322793652	S.A. Gadh
46	m. Jirfan Mujahid shailkh	11th sci	8010433068	<del>MITS</del> haikh
47	kuldip Solanki	11th Sci	8468836353	Kulder
48	Dikshant Punekar	11th science	9819312073	Dpunekar
49	Kaushal Noikose	11th science	8263007538	KNoikose
50	Yash chandhari	11th science	9156182205	Yash
51	Saumya Bhavsar	11th science	7028667477	Bhavsar
52	Pawar Shridhas Sandya	11th Science	9150800461	Sandya
53	Avishkar Kubal	11th Science	8010231996	Kubal
54	Harshad Bathe	11th science	9011639405	HAB
55	Shubhangi M. Jadhav	Juniel 11/11/19	9730044095	Shub
56	Malekar P. Sharad	TE. Comp.	7820929163	Pmalekar
57	Dhawal <sup>Sanika</sup> S. Karhavya	TE. Comp	7028501036	Karhavya
58	Pawar Akanksha Ashok	TE Comp	9503093377	Ashok
59	Dhawal Nikita Himmat	TE comp	9673690946	Dhawal
60	Talekar Anurana vijay	TE Comp	9970969940	Talekar
61	Jagtap Vaishnavi Sanjay	TE Comp	8482938011	Vaishnavi
62	Bhasale Sayali Aravin	TE comp	9665295413	Sayali
63	Yadav Rutuja Deepak	TE comp	9307184691	Rutuja
64	Bhaskar Vaishnavi D.	TE comp	7057560752	Bhaskar
65	Kudale Harshada .B	TE Comp	9112309736	HKudale
66	Salunke Gauri D	TE comp	7517755341	Salunke
67	shinde Rashmi R	TE comp	9146732703	Shinde
68	Tanpure sneha .P	TE comp	9021578233	Tanpure
69	Kale Renuka Nivrutti	TE comp	9325189605	RNKale





70	Shaikh Nilofar Abbas	TE comp.	7028500394	Shaikh
71	Ubhe Akash Avinas	J.E comp	8767301289	Ubhe
72	Salunkhe Sakshi Sandip	TE comp	9860703583	Salunkhe
73	Pujari Mahesh Mandappa	TE comp	9356967004	Pujari
74	Badadhe Damayanti D	TE Comp	9766792078	Damayanti.
75	Ganeshkar Gayatri A	TE Comp	9822405752	Ganeshkar
76	Jagtap Sayali Sunil	TE comp	8767171475	Jagtap
77	Deshmukh Hema Tanaji	TE comp	7385491827	Deshmukh.
78	Deshmukh Sanika Parag	TE Comp	9322736256	Deshmukh
79	Bhosale Santet Pradip	TE comp	9284658551	Bhosale
80	Gaikwad Sakshi Abasaheb	TE Comp	9881755092	Gaikwad S.A.
81	Bhandarkar Anuradha M.	TE Comp	9890830868	Bhandarkar
82	Bhore Akash Rajendra	TE comp	8928535232	Akash
83	Chourasija Dhanan Rajesh	TE Comp	7620178775	Chourasija
84	Dhamal Sejal Sunil	TE comp	7620375255	Dhamal
85	Bhosale Suraj Dadas	TE comp	7243365810	S.D. Bhosale
86	Deshmukh Syash Dilip	TE comp	9370180873	Deshmukh
87	Tankar Tejaswini Vijay	TE Comp	7249033513	T.V. Tankar.
88	Prof. B.R. Bhatti	Comp	9860816402	Bhatti
89	Prof. P.M. Marne.	Computer.	9158921212	PMARNE
90	Mahajan Kaushal Shamk	S.E Comp	8830132687	Mahajan
91	Parthe Durgesh B.	SE Comp	8999449060	Parthe
92	Salekar Omkar D.	S.E Comp	9322465132	Salekar
93	Kondhalkar Dipak. P	SE comp	8999498104	Dipak
94	Danavale Rutik S.	Comp	9623211603	Rutik





120	more Ankita sudam	SE comp	8554870910	<u>Amore</u>
121	Jalunkhe Anuja Dhanaji	SE Comp	9978612852	<u>Jalunkhe</u>
122	Raval Shraddha Bankim	S.E Comp	8208962763	<u>Shraddha</u>
123	Khopade Sakshi Suresh	S.E. Comp	8767316516	<u>Khopade</u>
124	Mohite Akankshasudhakar	S.E Comp	9925272910	<u>Mohite</u>
125	Zanje Aditi shiraji	S.E Comp	9890653717	<u>Zanje</u>
126	Budgude Shrivane Naunath	S.E Comp	9659368836	<u>Budgude</u>
127	Bhikre Pooja Kishan	S.E Comp	8010950058	<u>Bhikre</u>
128	Bhosale Shreya Sanjay	SE Comp	8530419644	<u>Bhosale</u>
129	Nevase Komal Bhausa	SE Comp	8668534570	<u>Nevase</u>
130	Chavan Sakshi Adhik	SE Comp	9767716591	<u>Chavan</u>
131	Kazi Lubna Gulabsha	S.E. Comp	8483011189	<u>L.G.Kazi</u>
132	Kodlinge Dnyaneshwar	S.E. Comp	7821933906	<u>Kodlinge</u>
133	Gaikwad Sanika Dilip	S.E. Comp	7249285855	<u>Gaikwad</u>
134	Gaikwad Rachana Amol	S.E. Comp	9767393081	<u>Rachana</u>
135	Mhaske Preeti Dnyaneshwar	S.E. Comp	8262863196	<u>Mhaske</u>
136	Shruti Suryakant APET	S.E. Comp	8010684070	<u>Shruti</u>
137	Doiphode Harshada Tukaram	S.E. Comp	9834487605	<u>Doiphode</u>
138	Devade Mitali Uttam	S.E. Comp	9307416549	<u>Mitali</u>
139	Bhalerao Pratiksha Vasant	S.E Comp	9763815125	<u>P.V.Bhalerao</u>
140	Kondhalkar Payal Pandurang	S.E. Comp	7798940014	<u>Kondhalkar</u>
141	Vaishnavi Ganesh Mane	S.E. Comp	8970533672	<u>Vaishnavi</u>
142	Kadam Vrushali Jaywant	SY Civil	9545452499	<u>Kadam</u>
143	Mokashi Payal Vasant Vasant	SY Civil	9322406894	<u>Mokashi</u>
144	Bondre Aarti Ganesh		8767152360	<u>Bondre</u>





145	Guttedar Snehal Shivling	S.Y. Civil	7840905693	<u>Guttedar</u>
146	Pawar Siddhi Rajendra	S.Y. Civil	7350711995	<u>Pawar</u>
147	Kulkarni Chaitrali Sunil	S.Y. Civil	8766601797	<u>Kulkarni</u>
148	Neelpatil Shrutika <sup>Vijay</sup>	S.Y. Civil	9284594976	<u>Shrutika</u>
149	Sapkal Himanshu Vijay	S.Y. Civil	9699394095	<del>_____</del>
150	Bandal Dnyandall Sachin	S.Y. Civil	9837545338	<u>D.S. Bandal</u>
151	Khutwad Pratik Sambhaji	S.Y. Civil	9527565370	<u>P.Khutwad</u>
152	Parthe Avinash Dinkar	S.Y. Civil	8766620317	<u>Parthe</u>
153	Sharma Vicky Vinod	S.Y. Civil	7821938415	<u>V.V. Sharma</u>
154	Yadav Datta Balaram	S.Y. Civil	9067754287	<u>Yadav</u>
155	Tathe Prem Hemant	S.Y. Civil	9322622700	<u>TATHE</u>
156	Kadam Aditya Uttam	S.Y. Civil	7709624159	<u>Kadam</u>
157	Mohite Gauri Tulcaram	S.Y. Civil	9730972150	<u>Mohite</u>
158	Ulhalkar Shrawan L.	S.Y. Civil	7057606164	<u>Ulhalkar</u>
159	Kamble Jaysing Ganesh	S.Y. Civil	7276241201	<u>J.G. Kamble</u>
160	Aryan Deepak Pawar	S.Y. Civil	7045889512	<u>Aryan</u>
161	Aditya Suresh Jagdale	S.Y. Civil	8855944729	<u>Aditya</u>
162	Abhijit Rasendra Jagdale	S.Y. Civil	9209069398	<u>Abhijit</u>
163	ROHAN Iqman Gole	S.Y. Civil	7499935524	<u>ROHAN</u>
164	Rahul S. Sutar	S.Y. Civil	9421582440	<u>Rahul</u>
165	Trupti Tanaji Khomare	F.Y. Civil	8010964942	<u>Trupti</u>
166	AKANKSHA R. KANK	F.Y. Civil	8080911595	<u>A.R. Kank</u>
167	Shrawani M. Talekar	F.Y. Civil	8830630357	<u>S.M. Talekar</u>
168	Naibhav D. Sheke	F.Y. Civil	8181010303	<u>Naibhav</u>
169	Suyash J. Choudhar	F.Y. Civil	8767088407	<u>Suyash</u>





170	Aryman N. Kapse	F.Y. civil	9356480357	A.N.Kapse
171	Nitin Chavan	F.Y. civil	8010228931	Nitin
172	Rohit Kolekar	F.Y. civil	8149290516	Rohit
173	Ayush Khetwadi	F.Y. civil	9307536544	Akhetwadi.
174	yash Jagtap	F.Y. civil	9049023838	yash
175	vrushabh Jagtap	F.Y. civil	9623441925	vt
176	siddhant D. Talekar	F.Y. civil	8669631146	SDT
177	Pranit B. Shinde	F.Y. civil	8788217588	Pranit...
178	Ganesh P. Daswadkar	F.Y. civil	9284031098	Daswadkar
179	Sujal Anil Jagadale	Sy com	8999224366	S
180	Samit H. Thombare	Sy. Com	9766151749	S.H.Thombare
181	Omkar P. Warkhade	Sy. com	9767162984	Omarkhade
182	Shiv R. Margeje	S.Y. com	8049076161	Shiv
183	Prathamesh S. Bavalekar	S.Y. com	7620975928	Prathamesh
184	Jaydip S. Salve	S.Y. com	9403409482	Jaydip
185	Ankit S. Jawale	S.Y. com.	8451917600	A.S.Jawale.
186	Sachin B. Kute	S.Y. com.	8766637501	Kute.
187	Banhit S. Khandekar	S.Y. com.	9373220205	Banhit
188	Sarthar S. Shinde	S.Y. com	9130323855	Sarthar
189	Om. B. Paygude	S.Y. com	8554002005	Paygude
190	Saurabh S. Jadhav	S.Y. com	8208672876	Saurabh
191	Vedant N. Reut	S.Y. com	9370185592	Reut
192	Pratik P. Prabhakar	S.Y. com	9511674970	Pratik
193	Pranav V. Thople	Sy. com	96050990	Pranav
194	Ardhut N. Namand	S.Y. com	7040689070	Ardhut





195	Bandal Puachi K.	SYCO	7499066255	Bandal
196	Bhosale Prabodhee	SYCO	9529835179	PmBhosale
197	Pardeshi Shreyal	SYCO	9284754381	<del>Pardeshi</del>
198	Bhosale Ankita	SYCO	9096433797	AshBhosale
199	Bhagat Ravina	SYCO	7558361708	Ravina
200	Bhagat Sakshi	SYCO	7499484750	<del>Bhagat</del>
201	Paway Pragati	SYCO	8766087278	<del>Paway</del>
202	Awale Sakshi	SYCO	7776856986	Awale
203	Pawar Purva	SYCO	7758996520	Pawar
204	Nikita Gundagad	SYCO	9900584804	<del>Nikita</del>
205	Chaitali Pilane	SYCO	9022013305	Chaitali
206	Kanishka Khopade	SYCO	9881692769	<del>Kanishka</del>
207	Anuja Thopate	SYCO	7972964766	@thopate
208	Kiran Indalkar	SYME	9730681581	@Indalkar
209	Rohan Kapare	SYME	9767409379	<del>Rohan</del>
210	Jadhav Vishal T	SYME	8530704672	Vishal
211	Vishal S. Jadhav	S.V.ME	8798219921	<del>Vishal</del>
212	Yash Gaikwad	S.Y.ME	9309343708	Gaikwad
213	Mahesh Kale	S.Y.ME	8767821118	<del>Mahesh</del>
214	Yogesh Kumkar	S.Y.ME	8432367063	Y.R.Kumkar
215	Avdhut Sowant	S.Y.ME	9322502912	A.R.Sowant
216	Prem Salunke	S.Y.ME	9561753545	P.R.Salunke
217	Minaj Ansari	S.Y.ME	9561045284	<del>Minaj</del>
218	Yash Vanave	SYME	7666433837	Vanave
219	Omkar Kamble		9867172234	Omkar





220	Parth Bhargude	SYME	8600451500	<u>parth</u>
221	Saxudnya Khorude	S.Y.M.E	8888996507	<u>S</u>
222	dayal P Jagtap	S.Y.M.E	8459881338	J.V. Jagtap
223	Sahil Toru	S.Y.M.E	7385637129	J.S. Toru
224	shreyash Jagtap	S.Y.M.E	8830549800	<u>Jagtap</u>
225	Aniket Mahangue	S.Y.M.E	7666463082	<u>AM</u>
226	sarth Sanas	S.Y.M.E	7038640808	<u>SSS</u>
227	shreyash mahangare	S.Y.M.E	9309330186	<u>Shreyash</u>
228	Prasad Mandhaze	S.Y.M.E	7888148042	<u>Prasad</u>
229	Darshan Pawar	S.Y.M.E	8446051380	<u>Pawar</u>
230	vedant wagh	S.Y.M.E	8149774020	<u>Wagh</u>
231	Aditya Thopte	S.Y.M.E	8208867049	
232	Omkar Khadpe	S.Y.M.E	9371956626	<u>khadpe</u>
233	Viraj Tikonkar	S.Y.M.E	7875430550	<u>Viraj Tikonkar</u>
234	Vaibhav Pangare	S.Y.M.E	9371293080	<u>Pangare</u>
235	Mayur Tekawade	S.Y.M.E	7758896933	<u>M.P. Tekawade</u>
236	Ishwari Samgir	SYME	7020091967	<u>Ishwari</u>
237	Shreya Pawar	SYME	7822010189	<u>Shyapawar</u>
238	Ishvari Shinde	SYME	7499105181	<u>Shinde</u>
239	Riya Mistri	SYME	9175936780	<u>Rishi</u>
240	Rahul Jadhav	SYME	9146394650	<u>RJadhav</u>
241	Harshad Gaikwad	SYME	8329969466	<u>Harshad</u>
242	Pratik P. Kade	SYME	8766783787	<u>Pratik</u>
243	Mauli.V. Chavan	SYME	9325529451	<u>Mauli</u>
244	Hrutik . S. Yedave		8251343818	<u>H. Yedave</u>



245	Deshmukh shreyas	SYME	7558394391	Fesbmukh
246	Kekade Suraj . R.	SYME	8888637080	
247	Kondhalkar Mangesh	T.E. (comp)	9822673877	MSK
248				
249				
250				

**Program Coordinator**

**Prof. H. R. Kondagurla  
Librarian**





# 6•Quiz on Rajmat Jijau and Swami Vivekananda Jayanti



Rajgad Dnyanpeeth's  
**SHRI CHHATRAPATI SHIVAJIRAJE COLLEGE OF ENGINEERING**  
S. No. 237, Satara-Pune, NH-4, Dhangawadi, Tal: Bhor, Dist: Pune

Date: 11<sup>th</sup> Jan 2023.

## NOTICE

All Students, Teaching & Non-Teaching staff of Rajgad Dnyanpeeth's Technical Campus, Shri Chhatrapati Shivajiraje College of Engineering, Dhangawadi are hereby informed that, in collaboration with **Department of Library & ICC Cell** Organized Quiz competition & Worship of Rajmata Jijau & Swami Vivekananda Birth Anniversary on 12<sup>th</sup> January, 2023 at 11 : 00 am.

Venue: - Central Library.

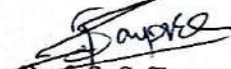
  
Prof. S. S. Tanpure  
Librarian (Diploma)  
**LIBRARIAN**  
RAJGAD DNYANPEETH'S TECHNICAL  
CAMPUS, POLYTECHNIC  
Dhangawadi, Tal: Bhor,  
Dist: Pune - 412205

  
Prof. H. R. Kondagurla  
Librarian (Degree)  
**LIBRARIAN**  
Shri Chhatrapati Shivajiraje  
College Of Engineering  
Dhangawadi, Tal. Bhor,  
Dist. Pune - 412205

  
Prof. J. G. Kale  
ICC Cell Chairman  
**Chairman**  
ICC

  
Prof. A. K. Kondhalkar  
Principal (Jr. College )  
**Principal**  
Rajgad Dnyanpeeth's  
Rajgad Junior College of Science  
Dhangawadi, Tal-Bhor, Dist-Pune-412205

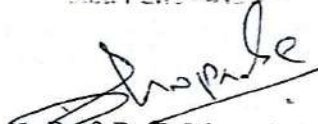
  
Prof. D. K. Khopade  
Principal (Diploma)  
**Principal**  
Rajgad Dnyanpeeth Technical Campus Polytechnic  
Dhangawadi, Tal. Bhor, Dist. Pune

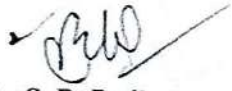
  
Prof. Dr. S. B. Patil  
Principal (Degree)  
**Principal**  
Rajgad Dnyanpeeth's  
Shri Chhatrapati Shivajiraje College of Engg.,  
Dhangawadi, Pune-412206





Rajgad Dnyanpeeth's  
**SHRI CHHATRAPATI SHIVAJIRAJU COLLEGE OF  
ENGINEERING**

S. No. 237, Satara-Pune, NH-4, Dhangawadi, Tal: Bhore, Dist: Pune

**Event On**

**“Rajmata Jijau & Swami  
Vivekanand Jayanti”**

**(12th January 2023)**

**Organized By**

**Department of Library**

**In association with**

**Internal Compliance Committee, Cell  
complaints  
RD's SCSCOE, Dhangawadi**







RajgadDnyanpeeth's

**SHRI CHHATRAPATI SHIVAJIRAJE COLLEGE OF ENGINEERING**

Gat No. 237, Pune Bangalore Highway, Dhangawadi, Tal – Bhor, Dist.- Pune (MH)

**Department of Library in Association with Internal Complaint  
Committee, Cell**

**Report on "Rajmata Jijau & Swami Vivekananda Birth Anniversary  
Celebration"**

Date: 13/01/2023

- 1. Program type:** Quiz & Event
- 2. Event Name:** Rajmata Jijau & Swami Vivekananda Birth Anniversary Celebration
- 3. Attendees:** Faculties and students from inside the institute.
- 4. Event coordinator:** Prof. H. R. Kondagurla (Librarian) and Prof. J.G. Kale (ICC Cell, Chairman )
- 5. Date of Execution:** 12/01/2023, Thursday
- 6. Duration of Event:** 11.00am-12.00pm
- 7. Venue of event / Link:** Library, RD's SCSCOE, Bhor
- 8. Number of Participants Student & Faculty for Event & Quiz:** 60/20
- 9. Objectives:** To commemorate the birth anniversary of Swami Vivekananda, maker of modern India, National Youth day is celebrated with great enthusiasm every year in India. And Jijamata journey is an example of how a mother can not only transform the fate of the society but also the fate of the nation.
- 10. Outcomes:** The students were motivated to be good citizens of India, thus contributing to the development of the country.
- 11. Description (program conduction details):** History always remembers the significance of man but there were many women who left such an impact on history that even today their praise is sung, bravery is remembered. One such magnificent person of women's value was Jijamata. Bunts Institute for High





Education observed the Birth Anniversary of Jijamata in the honor of the great lady for her contribution to the life of her son, Chhatrapati Shivaji Maharaj. She was the source of information and motivation not only for her son but for the whole Maratha Empire and our country.

**12. Conclusion:** The students were motivated to be good citizens of India, thus contributing to the development of the country. Jijamata journey is an example of how a mother can not only transform the fate of the society but also the fate of the nation. The younger generation instead of spending their quality time on unwanted things, should make their life more meaningful by studying Vivekananda and treading the path shown by him

### 13. Photos with caption



**Photo.1-Jijamata and Swami Vivekanand photo puja by Principal, Dr. S.B. Patil Sir**



**Photo.2- Light Lamping by Principal Sir, Estate Manager, Office Superident, HOD's and Faculty**







Photo.3- Principal Sir, Estate Manager, Office Superident, HOD's and Faculty



Photo.4- Student present for Jijaumata & Swami Vivekanand birth Anniversary Celebration

**Prof. H. R. Kondagurla**  
**LIBRARIAN**  
 Shri Chhatrapati Shivajiraje  
 College of Engineering  
 Dhangwadi, Tal. Bhor,  
 Dist. Pune - 412206

**Prof. J. G. Kale**

**ICC Cell, Chairman**  
**Chairman**  
**I.C.C.**

**Shri chhatrapati Shivajiraje**  
**College of Engineering**  
**Dhangwadi, Pune - 412206**

**Prof. Dr. S. B. Patil**

**Principal**  
 Rajgad Dnyanpeeth's  
 Shri Chhatrapati Shivajiraje College of Engg.,  
 Dhangawadi, Pune-412206







Rajgad Dnyanpeeth's

**Shri Chhatrapati Shivajiraje College of Engineering, Dhangawadi**

(Approved by AICTE, Recognized by Government of Maharashtra & Affiliated to Savitribai Phule Pune University, Pune)

Dhangawadi, Tal: Bhor, Dist: Pune, Maharashtra, India  
Website: www.rajgad.edu.in Email: scscoe@gmail.com

**Library Department and ICC Cell**



**“Rajmata Jijau & Swami Vivekanand Jayanti” - Quiz Competition**

**CERTIFICATE OF PARTICIPATION**

This is to certify that,

**Salvi Riya Sandeep**

has successfully completed “Rajmata Jijau & Swami Vivekanand Jayanti” Organized by Library Department and ICC Cell, RD's Shri Chhatrapati Shivajiraje College of Engineering, Dhangawadi, Pune-412205 on 12 Jan. 2023.

Prof. H. R. Kondagurla  
Librarian

Prof. J. G. Kale  
ICC Cell, Chairman



Dr. S. B. Patil  
Principal



**Rajmata Jijau Jayanti and Swami Vivekananda  
Jayanti - Quiz Competition-ICC Cell and Library  
Department-RD's SCSCOE, Dhangawadi**

राजमाता जिजाऊ साहेब आणि स्वामी विवेकानंद यांच्या जयंतीनिमित्त सामान्यज्ञान प्रश्नसंज्ञुषा

\* Required

1. **Name \***

2. **Address \***

3. **Mobile number \***

4. **School / College Name \***



5. **Class \***

*Mark only one oval.*

FE

S.E

T.E

B.E

Faculty

6. **Branch \***

*Mark only one oval.*

Civil Engineering

Mechanical Engineering

Electronic & Telecommunication Engineering

Computer Engineering

Other

7. 1) **जिजामाता यांचा जन्म कधी झाला? \***

*Mark only one oval.*

12 जानेवारी 1598

12 जानेवारी 1698

12 जानेवारी 1600

12 जानेवारी 1588





11. 5) ----- रोजी शिवनेरी येथे जिजाबाई यांना मुलगा झाला मुलाचे नाव शिवाबाई ठेवले ?

Mark only one oval.

19 फेब्रुवारी 1530

19 फेब्रुवारी 1630

19 फेब्रुवारी 1730

19 फेब्रुवारी 1830

12. 6) वयाच्या ऐंशीव्या वर्षी जिजाबाईचे ----- पायथ्याशी असलेल्या पाचाड गावी वृद्धापकाळाने निधन झाले या गावी जिजाबाईची समाधी आहे?

Mark only one oval.

रायगडाच्या

शिवनेरीच्या

कोंढाण्याच्या

राजगडाच्या

13. 7) जिजाबाई यांच्या आईचे नाव काय होते? \*

Mark only one oval.

सगुणाबाई

लक्ष्मीबाई

म्हाळसाबाई उर्फ गिरिजाबाई

यापैकी नाही



14. 8) इ. स. 1605 मध्ये जिजाबाईचा शहाजीराजांनी ----- येथे विवाह झाला. \*

Mark only one oval.

प्रतापगड

दौलताबाद

शिवनेरी

राजगड

15. 9) शिवरायांचा राज्याभिषेक कधी झाला? \*

Mark only one oval.

6 जून 1674

6 जून 1670

6 जून 1647

6 जून 1678

16. 10) जिजामाता यांचा मृत्यू कधी झाला? \*

Mark only one oval.

17 जून 1674

17 जून 1684

17 जून 1694

17 जून 1678



17. 11) स्वामी विवेकानंद यांचे लहानपणीचे नाव काय होते? \*

Mark only one oval.

विवेकानंद

स्वामी

नरेंद्रनाथ दत्ता

स्वामी विवेकानंद

18. 12) स्वामी विवेकानंद यांचा जन्म कधी झाला? \*

Mark only one oval.

१२ जानेवारी १८६३

४ जुलै १९०२

१२ जानेवारी १९०२

४ जुलै १८६३

19. 13) युवक दिन कधी साजरा केला जातो (स्वामी विवेकानंद जयंती)? \*

Mark only one oval.

१२ जानेवारी

४ जुलै

४ जानेवारी

यापैकी नाही



20. 14) स्वामी विवेकानंद यांच्या आईचे नाव काय होते? \*

Mark only one oval.

- भुवनेश्वरी देवी  
 अनुसया देवी  
 लक्ष्मी देवी  
 यापैकी नाही

21. 15) स्वामी विवेकानंद यांचे निधन कधी झाले? (वय ३९ वर्ष) \*

Mark only one oval.

- १२ जानेवारी १८६३  
 ४ जुलै १९०२  
 १२ जानेवारी १९०२  
 ४ जुलै १८६३

22. 16) स्वामी विवेकानंद यांचे गुरु कोण होते? \*

Mark only one oval.

- रामकृष्ण परमहंस  
 सच्चिदानंद  
 रामदास स्वामी  
 यापैकी नाही



23. 17) स्वामी विवेकानंद यांचा जन्म कोठे झाला? \*

Mark only one oval.

मुंबई

कलकत्ता

इंदोर

भीषाल

24. 18) स्वामी विवेकानंद अमेरिकेला कधी गेले? \*

Mark only one oval.

४ जुलै १८६३

३१ मे १८९३

२७ ऑगस्ट १८९४

यापैकी नाही

25. 19) स्वामी विवेकानंद यांच्या वडिलांचे नाव काय होते? \*

Mark only one oval.

रामकृष्ण दत्त

विश्वनाथ दत्त

रामेश्वर दत्त

यापैकी नाही

26. 20) रामकृष्ण मिश्र  
Mark only one oval.  
महात्मा गांधी  
रामकृष्ण



26. 20) रामकृष्ण मिशन की स्थापना कुणी केली? \*

Mark only one oval.

- महात्मा गांधी
- रामकृष्ण परमहंस
- स्वामी विवेकानंद
- गाडगे बाबा



This content is neither created nor endorsed by Google.

Google Forms



Department of Library and ICC Cell

Day: Thursday

Date: 12/01/2023

Time: 11.00am-12.00pm

Title of Program: Event on, " Rajmata Jijau & Swami Vivekananda Birth Anniversary Celebration"

Attendance Sheet

Sr. No.	Full Name	Department	Mobile No.	Sign
1	Renuse Prathamesh Rambhau	F.E Computer Engineering	9604109297	<u>Renuse</u>
2	Thombare Abhinav Anandaro	F.E Civil Engineering	8177847923	<u>Abhinav</u>
3	Power Ved Chandrakant	F.E. ENTC Engineering	8010173044	<u>Power</u>
4	Madake Atharav Abasaheb	F.E. comp. Engineering	9552714871	<u>Madake</u>
5	Vivek Vinayak Virkar	FE. comp. Engineering	9503152003	<u>Vivek</u>
6	Shreyas Sunil Raut	F.E ENTC Engineering	9421359745	<u>Shreyas</u>
7	Mohajan Harshvardhan Mahajan	F.E Computer Engineering	9284625193	<u>Mohajan</u>
8	Sahane Shalish Radhakisan	F.E. computer engineering	9408202978	<u>Sahane</u>
9	Kumkar Digambar Shahaji	F.E Civil engineering	969986442	<u>Kumkar</u>
10	Pujari Vishal vilas	F.E. Computer engineering	8010086398	<u>Pujari</u>
11	Sonawane pranav Sudhakar	F.E E & TC Engineering	9970626974	<u>Sonawane</u>
12	Phand Digvijay Harishchandra	F.E E & TC Engineering	8446459492	<u>Phand</u>
13	Raut Yash Suresh	F.E computer Engineering	9699234251	<u>Raut</u>
14	Pardeshi Harsh Santosh	F.E Computer Engineering	9665317064	<u>Pardeshi</u>
15	Kute Sushant Balkrishna	F.E Mech Engineering	7499612296	<u>Sushant</u>
16	Pisal Atharv Nilesh	F.E Mech Engineering	9175794738	<u>Pisal</u>
17	Vanarse Nikhil Santosh	FE Computer Engineering	9322562081	<u>Vanarse</u>
18	Kondhalkar omkar Ramdas.	FE. MEch Engineering	9637573012	<u>Kondhalkar</u>
19	Sanas Pratik Rajaram	F.E CIVIL Engineering	7264996741	<u>Sanas</u>





20	Tingare Aditya Vitthal	EE Comp. Engg.	8010949626	<u>Tingare</u>
21	Shinde Darshan Suresh	F.E		
22	Maeggaje Rutuja Rajendra	SE (E&TC) Engineering	9307911917	<u>Maeggaje</u>
23	Gaikwad Sakshi Bhimaji	SE (E&TC) Engineering	8767960689	<u>Gaikwad</u>
24	Khopade Rutuja Sandip	SE (E&TC) Engineering	9373052814	<u>Khopade</u>
25	Dhumal Shivajali Santosh	SE (E&TC)	7397945767	<u>Shivajali</u>
26	Amhalikar Akshada Yashwant	SE (E&TC)	9960683285	<u>Akshada</u>
27	Mankar Priyanka Bharat	SE (E&TC)	8766798057	<u>Mankar P.B.</u>
28	Gole Shruti Sunil	SE (E&TC)	9156009109	<u>Gole</u>
29	Gole Pradnya Laxman	SE (E&TC)	8806246665	<u>Gole</u>
30	Jagtap Aditya Sanjay	SE (E&TC)	9373751128	<u>Jagtap</u>
31	Jedhe Deep Satish	SE (E&TC)	8329934073	<u>Jedhe</u>
32	Phalankar Deepak Suman	SE (E&TC)	9975746582	<u>Phalankar</u>
33	Dotkar Sameer Bhanudas	SE (E&TC)	9067671977	<u>Dotkar</u>
34	Ghore. Kishor. R	SE (E&TC)	7083944439	<u>Ghore</u>
35	Horai Vijay Vikas	S.E (E&TC)	8766820842	<u>Horai</u>
36	Ambike Atul Vilas	S.E (E&TC)	7499634241	<u>Ambike</u>
37	Dudhane Devang Dattatraya	S.E (E&TC)	7447209145	<u>Dudhane</u>
38	Abhishek Sambhaji Mangutkar	S.E (E&TC)	9689604551	<u>Abhishek</u>
39	Dhaigude Aditya Ganpat	SE (E&TC)	9858950707	<u>Dhaigude</u>
40	Deshmukh Adesh Hemant	S.E (E&TC)	8830396758	<u>Deshmukh</u>
41	Kamble Anant D.	E&TC	9762101062	<u>Kamble</u>
42	Sutar Amruto Rajendra	SE. E&TC	9359266216	<u>Sutar</u>
43	Shikhare Swati Ravindra	SE- E&TC	7447954793	<u>Shikhare</u>
44	Pawar Pratima Shankar	SE- E&TC	7972772198	<u>Pratima</u>

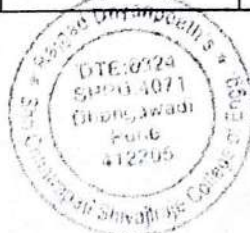



45	Pat Rutuja Rajoram	SE (E & TC)	9767431792	<u>Pat</u>
46	Pawar Pratikha P. S.	SE (E & TC)	9218875600	<u>Pawar</u>
47	Salunkhe Peachi Balasahab	SE (E & TC)	8421318898	<u>Salunkhe</u>
48	Mohale Priyal Lalit	SE (E & TC)	9172658678	<u>Mohale</u>
49	Patil Preeti Mahamoy	SE (E & TC)	9970873208	<u>P.M. Patil</u>
50	Phadtare Anpita Sunil	SE (E & TC)	9699507084	<u>Phadtare</u>
51	Yewale Shivam R.	SE (E & TC)	9689404098	<u>Shivam</u>
52	Thite Jaywant Dattatray	S.E (E & TC)	8806704353	<u>Thite</u>
53	Shilimkar Yash	S.E (E & TC)	9146085577	<u>Shilimkar</u>
54	Shinde Omkar Suresh	S.E (E & TC)	8855086238	<u>Shinde</u>
55	Kumbhar Kedar D.	SE (E & TC)	8010944799	<u>Kumbhar</u>
56	Yadav Shreyas C.	SE (E & TC)	8983071315	<u>Yadav</u>
57	Sawant Omkar Prasad.	SE (E & TC)	7843012635	<u>Sawant</u>
58	Pengul Reshma Tonaji	SE (E & TC)	7208497230	<u>Pengul</u>
59	Pawar Kajal Rajendra	SE (E & TC)	9518994868	<u>Pawar</u>
60	Bandal Jyoti Jayendra	E & TC	9657498032	<u>Bandal</u>

Program Coordinator

J. G. Kale

Prof. J. G. Kale

ICG Cell Chairman

I.C.C.

RD : Shri Chhatrapati Shivaji  
College of Engineering  
Dhangwadi, Pune - 412205



H. R. Kondagurla

Prof. H. R. Kondagurla

**LIBRARIAN**

Shri Chhatrapati Shivaji

College Of Engineering

Dhangwadi, Tal. Bhor,

Pune - 412205





Department of Library and ICC Cell

Day: Thursday

Date: 12/01/2023

Time: 11.00am-12.00pm

Title of Program: Event on, " Rajmata Jijau & Swami Vivekananda Birth Anniversary Celebration"

Attendance Sheet

Sr. No.	Full Name	Department	Mobile No.	Sign
1	R.L. Thombare	Mechanical	9022299792	
2	D.A. More	Mech.	8097297665	
3	S.V. Jagtap	Mech	8806311333	
4	N.D. Bagel	Mech	8698486085	
5	S.P. Salunke	Govt	9860171442	
6	S.S. Tampure	Library	9049512021	
7	V. D. Dixit	Library	9527244852	
8	S.D. Pasalkar	E&TC	8605592555	
9	A.T. Jadhav	Mech	7711992011	
10	G.S. Yadav	Civil	9769173372	
11	R.C. Divekar	Civil	9022527167	
12	B.R. Bhatti	Comp	9860816402	
13	P.M. Marne	Comp.	9158921212	
14	A.R. Bobade	FE	8796170172	
15	S.M. Jadhav	First year	9730044095	
16	S.S. Lambhate	First year	9766955641	
17	R.S. Nipanikar	E&TC	9130174183	
18	P.R. Zende	E&TC	9881891498	
19	S.S. Nipanikar	E&TC	8459909962	





20	Prof J G Kale	F-E	9011826102	Kale
21				
22				
23				
24				
25				
26				
27				
28				
29				
30				
31				
32				
33				
34				
35				
36				
37				
38				
39				
40				

Program Coordinator

*Kale*

Prof. J. G. Kale  
 ICC Cell Chairman  
 Chairman  
 I.C.C.

Shri Chhatrapati Shivaji  
 College of Engineering  
 Dhangwadi, Pune - 412205



*H.R. Kondagurla*

Prof. H. R. Kondagurla  
 LIBRARIAN  
 Shri Chhatrapati Shivaji  
 College Of Engineering  
 Dhangwadi, Tel. Dhur,  
 Dist. Pune - 412205





Rajgad Dnyanpeeth's

**SHRI CHHATRAPATI SHIVAJIRAJE COLLEGE OF ENGINEERING**

Gat No. 237, Pune Bangalore Highway, Dhangawadi, Tal – Bhor, Dist- Pune (Maharashtra)

**REPORT ON SPORTS COMPETITION 2022-23****DEPARTMENT: All****TITLE/TOPIC: ANNUAL SPORTS COMPETITION 2022-23****DAY & DATE: Tuesday, 23/01/2023 to Monday, 03/02/2023.****STUDENT/STAFF PRESENT: 600 /15 CO-ORDINATOR: Prof. P. J. Gaikwad**

**OBJECTIVE:** The primary objective of the Annual Sports Competition is to promote physical well-being, camaraderie, and a sense of community by providing a platform for inclusive participation in sports and fostering a culture of healthy competition within the organization.

**DESCRIPTION:**

The occasion was blessed with the presence of Prof. Dr. S. B. Patil (Principal, SCSCOE), Prof. H.R. Kondagurla and Prof. G.H. Phadtare (Judge of the Event) and other Teaching, Non-teaching faculty of the college. The event was coordinated by Prof. P.J. Gaikwad with support of Coordinators of various competition team. The competition witnessed active participation from individuals across various age groups and skill levels. Students from different academic departments, faculty members, and support staff all contributed to the vibrant atmosphere, creating a sense of unity and shared enthusiasm for sports.

**SPORTS EVENTS:**

The Annual Sports Competition 2022-23 featured a variety of sports to cater to different interests and skill sets. The events included:

1. Track and Field: Running 400m, Tug of war showcased the participants' speed, agility, and endurance.
2. Team Sports: Kabaddi, Volleyball, and Cricket brought together teams to compete in spirited
3. Individual Sports: Badminton, carom, and chess allowed participants to showcase their individual skills and compete in a more focused setting.







Fig2. Badminton Competition



Fig3. Cricket Competition



Fig4. Kabaddi and volleyball Competition





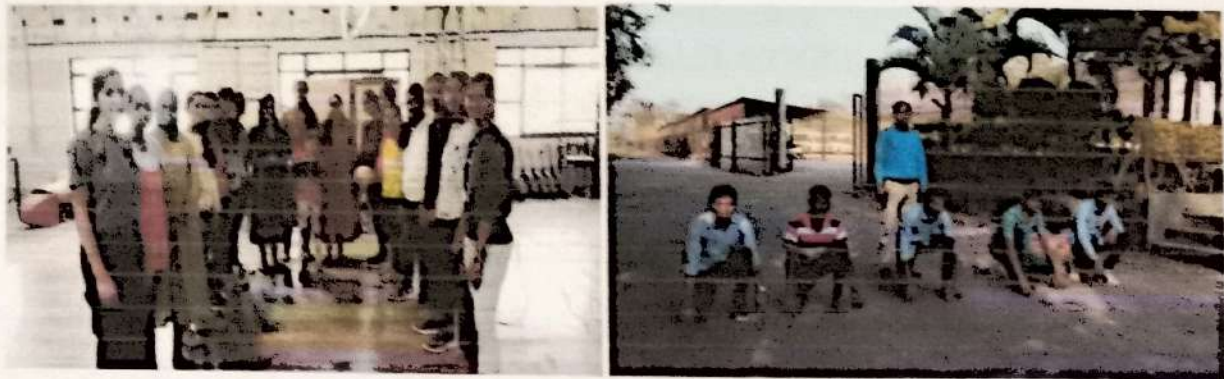

Fig4. Throw ball and Running Competition

#### AWARDS AND RECOGNITION:

Individuals and teams who excelled in their respective events were recognized and awarded during the closing ceremony. Awards were given for Best Male and Female solo games winners, Best Team in all sports as a winners and runners.

*P.J. Gaikwad*  
30/11/23

Prof. P.J. Gaikwad  
Event Coordinator



*S.B. Patil*

Prof. Dr. S. B. Patil  
Principal



Rajgad Dnyanpeeth's  
**SHRI CHHATRAPATI SHIVAJIRAJE COLLEGE OF ENGINEERING**  
Gat No. 237, Pune Bangalore Highway, Dhangawadi, Tal – Bhor, Dist- Pune (Maharashtra)

**PRIZE DISTRIBUTION – SPORTS COMPETITION 2022-23**

Sr. No	Sport Name	Rank	Name of the Participants			
			GIRLS	Class	BOYS	Class
1.	Chess	1st	Shravani Jadhav	F.E(Div-A)	Akash Ubhe	T.E.Comp.
		2nd	Gayatri Ganeshkar	T.E Comp	Anup Lawand	F.E(Div-B)
2.	Carrom (Doubles)	1st	Priyanka Chandanshiv & Shruti Gire	F.E(Div-A)	Mujeeb Kazi & Shubham Pansare	B.E. Civil
		2nd	Vaishnavi Vedpthak & Shabana Ansari	T.E. Comp F.E(Div-A)	Shreyash Jadhav & Sarthak Dhaigude	F.E (Div-A)
3.	Running	1st	Mansi Tanpure	B.E. Civil	Ayan Shaikh	B.E. Civil
		2nd	Vaishnavi Kuchekar	T.E Comp.	Ganesh Jadhav	F.E
4.	Badminton (Doubles)	1st	Sakshi Salunke & Anuradha Bhandari	T.E Comp.	Aditya Shinde & Chandrakant Tawade	F.E (Div-c)
		2nd	Vaishnavi Kuchekar & Sanskruti Pawar	T.E Comp.	Omkar Dudhane & Prathamesh Chaudhari	F.E (Div-A)
5.	ThrowBall	1st	Sakshi Salunke Team	T.E. Comp.		
		2nd	Rutuja Babar and Team	B.E. ETC		
6.	VolleyBall	1st			Atharva Pardeshi Team	B.E. E & TC
		2nd			Akash Ubhe & Team	T.E. Comp.
7.	Kabaddi	1st			Dhiraj More & Team	T.E. Mech.
		2nd			Shubham Pawar Team	F.E (Div-A)
8.	Cricket	1st	Sanika Pisal & Team	T.E. Mech.	Sumit Barge & Team	T.E. Mech.
		2nd	Sanskruiti Pawar & Team	T.E. Comp.	Ajinkya Dhadave & Team	B.E. Comp.

*P.J. Gaikwad*  
30/1/2023

Prof. P.J. Gaikwad  
Event Coordinator

*S.B. Patil*

Prof. Dr. S. B. Patil  
Principal

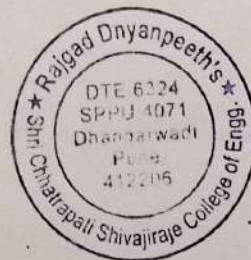





RajgadDnyanpeeth's

**SHRICHHATRAPATISHIVAJIRAJGECOLLEGE OF ENGINEERING**

S.No.237,Satara-Pune,NH-4,Dhangawadi,Tal:Bhor,Dist:Pune-

412205(MS),India. Website:[www.rajgad.edu.in](http://www.rajgad.edu.in),EmailId:[scscoe@gmail.com](mailto:scscoe@gmail.com)

Date-14/01/2023

### Sports Schedule

Sr. No.	Name of Game		Days		Name of Staff
	For Boys	For Girls	For Boys	For Girls	
1	CRICKET	CRICKET	23/01/2023	24/01/2023	Prof. P.J. Gaikwad Prof. S.D. Pasalkar
2	CARROM (Doubles)	CARROM (Doubles)	23/01/2023	25/01/2023	Prof. R.S.Nipanikar Prof. G.S.Yadav
3	CHESS	CHESS	23/01/2023	25/01/2023	Prof. R.S.Nipanikar Prof. G.S.Yadav
4	RUNNING (100M) Tug-of-War	RUNNING (100M) Tug-of-War	23/01/2023	25/01/2023	Prof. M. B.Bankar Prof. R. B.Raut
5	---	THROWBALL BADMINTON (Doubles)	23/01/2023	25/01/2023	Prof. P.M.Marne Prof. S.B.Shirke
6	VOLLEY BALL BADMINTON (Doubles)	---	24/01/2023	25/01/2023	Prof. A. K. Kondhalkar Prof. A.T. Jadhav
7	KABBADI	---	25/01/2023	25/01/2023	Mr. H.R. Kondagurle Prof. G.H. Phadtare

Note: Entries after 20<sup>th</sup> January 2023 will not considered.

  
14/1

Prof. P.J. Gaikwad  
(Sports In-Charge)



Prof. Dr. S. B. Patil  
(Principal)





RajgadDnyanpeeth's  
**SHRICHHATRAPATISHIVAJIRAJECOLLEGE OF ENGINEERING**

S.No.237,Satara-Pune,NH-4,Dhangawadi,Tal:Bhor,Dist:Pune-  
412205(MS),India. Website:[www.rajgad.edu.in](http://www.rajgad.edu.in),EmailId:[scscoe@gmail.com](mailto:scscoe@gmail.com)

Date-14/01/2023

**SPORTS DEPARTMENT 2022-23**

**Notice**

All the students of S.E, T.E, and B.E are hereby informed that, "**Annual Sports Events 2022-23**" will be conducted in our campus from **30<sup>th</sup> January 2023 to 3<sup>rd</sup> February 2023**. All the class representatives are informed to submit their entries with participants name till **25<sup>th</sup> January 2023**.

So all interested participants are informed to submit their entries to following staffs:

Sr. No.	Name of Game		Staff Coordinator	Mobile Number
	For Boys	For Girls		
1	CRICKET	CRICKET	Prof. P.J. Gaikwad Prof. S.D. Pasalkar	9623701963 8605592551
2	CARROM (Doubles)	CARROM (Doubles)	Prof. R.S.Nipanikar Prof. G.S.Yadav	8888815939 9769173372
3	CHESS	CHESS	Prof. R.S.Nipanikar Prof. G.S.Yadav	8888815939 9769173372
4	RUNNING (100M)	RUNNING (100M)	Prof. M. B.Bankar Prof. R. B.Raut	9730949108 7248997216
5	BADMINTON (Doubles)	BADMINTON (Doubles)	Prof. P.M.Marne Prof. S.B.Shirke	9158921212 9422649646
6	VOLLEY BALL	THROWBALL	Prof. A. K. Kondhalkar Prof. A.T. Jadhav	9552929399 7755978595
7	KABBADI	---	Mr. H.R. KondagurlaProf. G.H. Phadtare	9405092611 9561010348

Note: Entries after 25<sup>th</sup> January 2023 will not considered.

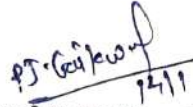
  
Prof. P.J. Gaikwad  
(Sports In-Charge)

  
Prof. Dr. S. B. Patil  
(Principal)







Rajgad Dnyanpeeth's

SHRI CHHATRAPATI SHIVAJIRAJE COLLEGE OF ENGINEERING

S. No. 237, Satara-Pune, NH-4, Dhangawadi, Tal: Bhor, Dist: Pune -412205 (MS), India.

Website: [www.rajgad.edu.in](http://www.rajgad.edu.in), Email Id: [sescoc@gmail.com](mailto:sescoc@gmail.com)

Annual Sports A. Y. 2022-23

Event Date: 24/01/2023

Name of the Event: Running (100m) / Badminton / Chess / Carrom

Sr. No.	Name of student	Class & Branch	Contact number	Date of Birth	Sign
1	Shivanjali Dhumal	F.E. A	7397945767	6-10-2003	
2	Bhosale Shreya	FE-A	8530419644	01-06-2003	
3	Simran Chavan	FE-A	7248900137	15-11-2003	
4	Akshada Amthalikar	F.E-A	9960683285	27-09-2002	
5	Rutuja Maegaje	F.E-B	8669177809	18-3-2003	
6	Priyank Mankar	F.E-B	8766798057	25-04-03	
7	Gaikwad sukshi	FE-A	8767960689	21/07/03	
8	Budgude Shrawanee	FE-A	9699369836	23/07/2002	
9	Rutuja Jadhav.	FE-A	9156498845	05/02/2003	
10	Haral Apurva	FE-A	7499175852	02/08/2003	
11	Pawar Pranjita	FE-B	9373705813	08/08/2003	
12	Nevase Komal	FE-B	9		
13	Anuja Salunkhe	PE-B	9978612852	17-2-2004	
14	Rachna Gaikwad.	FE-A	9767393081	21-9-2003	

Sports Co-ordinator

Sport Head

Sports club - Academic Year 2022-23

Schedule: Date-21/01/2023

Start Date: 23/01/2023.

Name of Event: ~~Chess~~ Badminton

Duration:

1. ~~Board no 1~~: Round: 2. TE - mech

Player Name	Vs	Player Name
Dhame shrinavas		shinde Adarsha

2. Board no 2: Round: TE - comp.

winner -

Player Name	Vs	Player Name
<del>omkar totkar</del> Kunal Mandave		Dipak shinde

3. ~~Board no 3~~: Round: TE Comp.

Player Name	Vs	Player Name
Abhinav walhekar		Yashbhav khirsagar

4. Board no 4: Round: TE - mech.

winner.

Player Name	Vs	Player Name
Karan yadav		Kiran Hariker

5. Board no 5: Round: SE - comp.

winner.

Player Name	Vs	Player Name
Mandar shahane.		Amey Deshpande

6. Board no 6: Round: FE.

Player Name	Vs	Player Name
Nigade utkarsha		Kudale omkar.

  
Sports coordinator

  
Sports Head

Estate manager

Principal



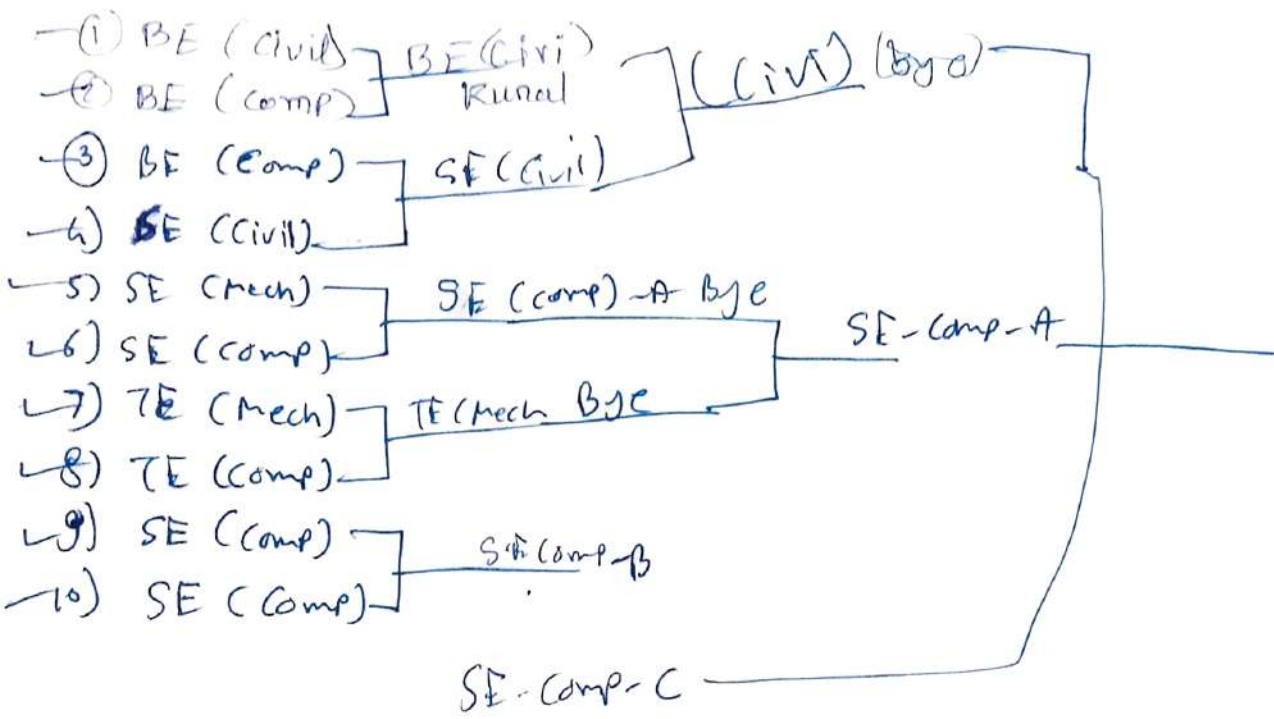

P. G. Gait  
 21/11/2023







**Sports club - Academic Year 2022-23**

Schedule: Day-1/2/3/4/5

Start Date: 03/03/2023.

**Name of Event: Volley ball**

**1. Match 1: Round 1: Time: 10.30 a:m Onwards**

Team A	Vs	Team B
<b>FE.A</b>		<b>BE Computer</b>

**2. Match 2: Round 2**

Team A	Vs	Team B
<b>TE Mechanical</b>		<b>TE Civil</b>

**3. Match 3: Round 2**

Team A	Vs	Team B
<b>BE Mechanical</b>		<b>FE.B</b>

**4. Match 4: Round 2**

Team A	Vs	Team B
<b>SE Computer</b>		<b>SE Mechanical</b>

**5. Match 5: Round 2**

Team A	Vs	Team B
<b>Winner of 1<sup>st</sup> match</b>		<b>SE E&amp;TC</b>

**6. Match 6: Round 2**

Team A	Vs	Team B
<b>Winner of 2<sup>nd</sup> match</b>		<b>Winner of 3<sup>rd</sup> match</b>

**7. Match 7: Round 3: (Semifinal):**

Team A	Vs	Team B
<b>Winner of 5<sup>th</sup> match</b>		<b>Winner of 4<sup>th</sup> match</b>

**8. Match 8: (Final):**

Team A	Vs	Team B
<b>Winner of 6<sup>th</sup> match</b>		<b>Winner of 7<sup>th</sup> match</b>

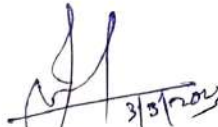
  
Sports coordinator  
(Prof. A.T. Jadhav)

  
Sports Head  
(Prof. K.L. Ghoshjani)

  
Estate manager

  
Principal

RD'S SCSCOE

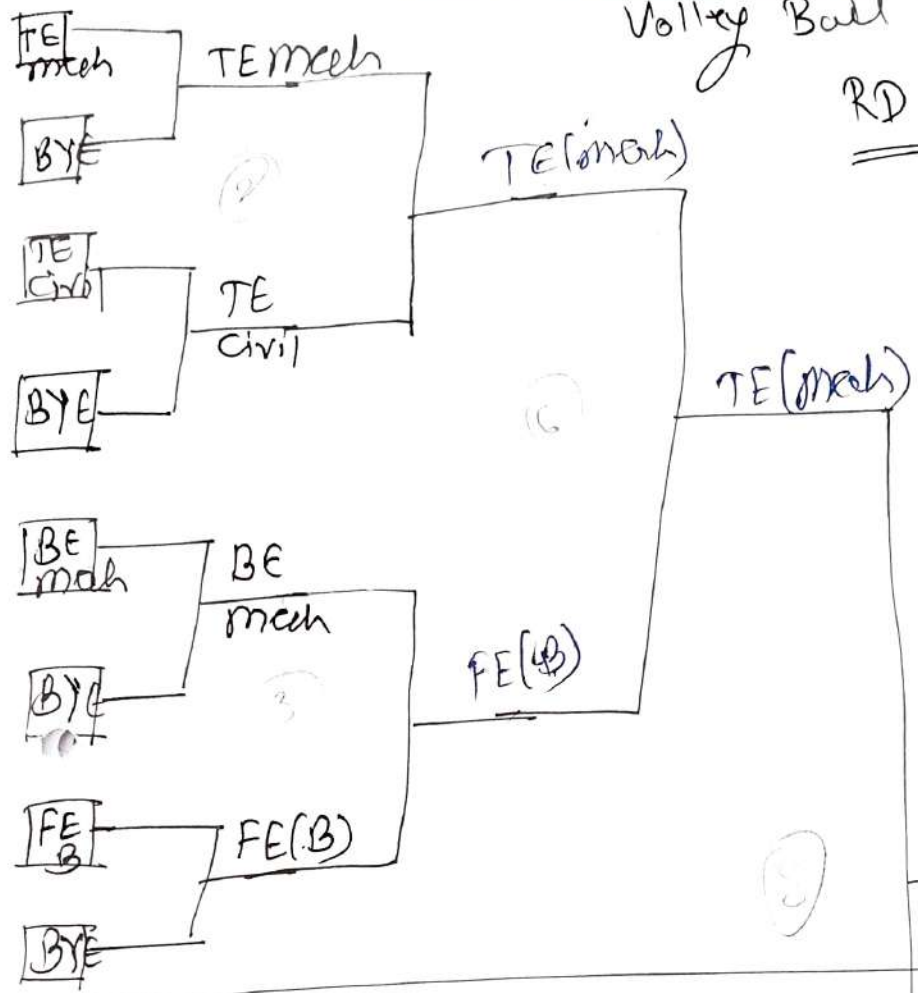

Final  
B.E. (Comp)

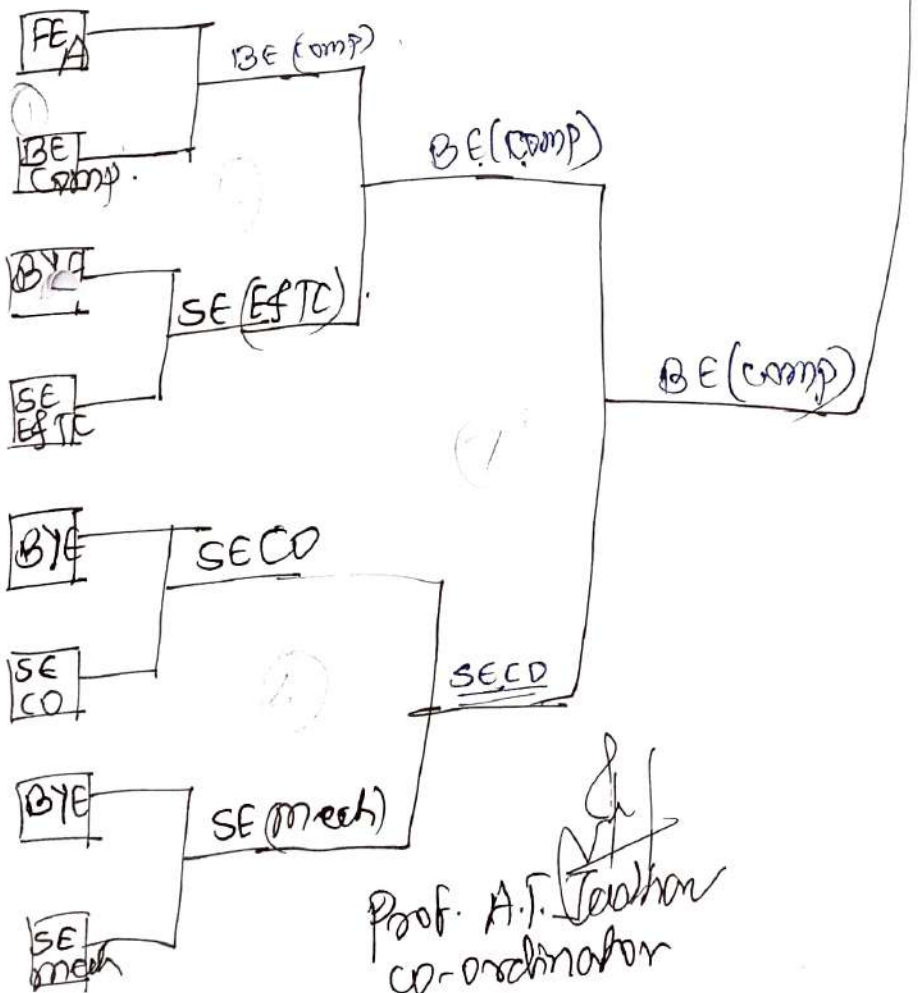

~~Arifet~~  
TE mech

~~Arifet~~  
FE comp.

~~Arifet~~  
TE.Mech

~~Arifet~~  
B.E. comp

Prof. A.T. Jadhav  
co-ordinator



RD'S SCSCOE

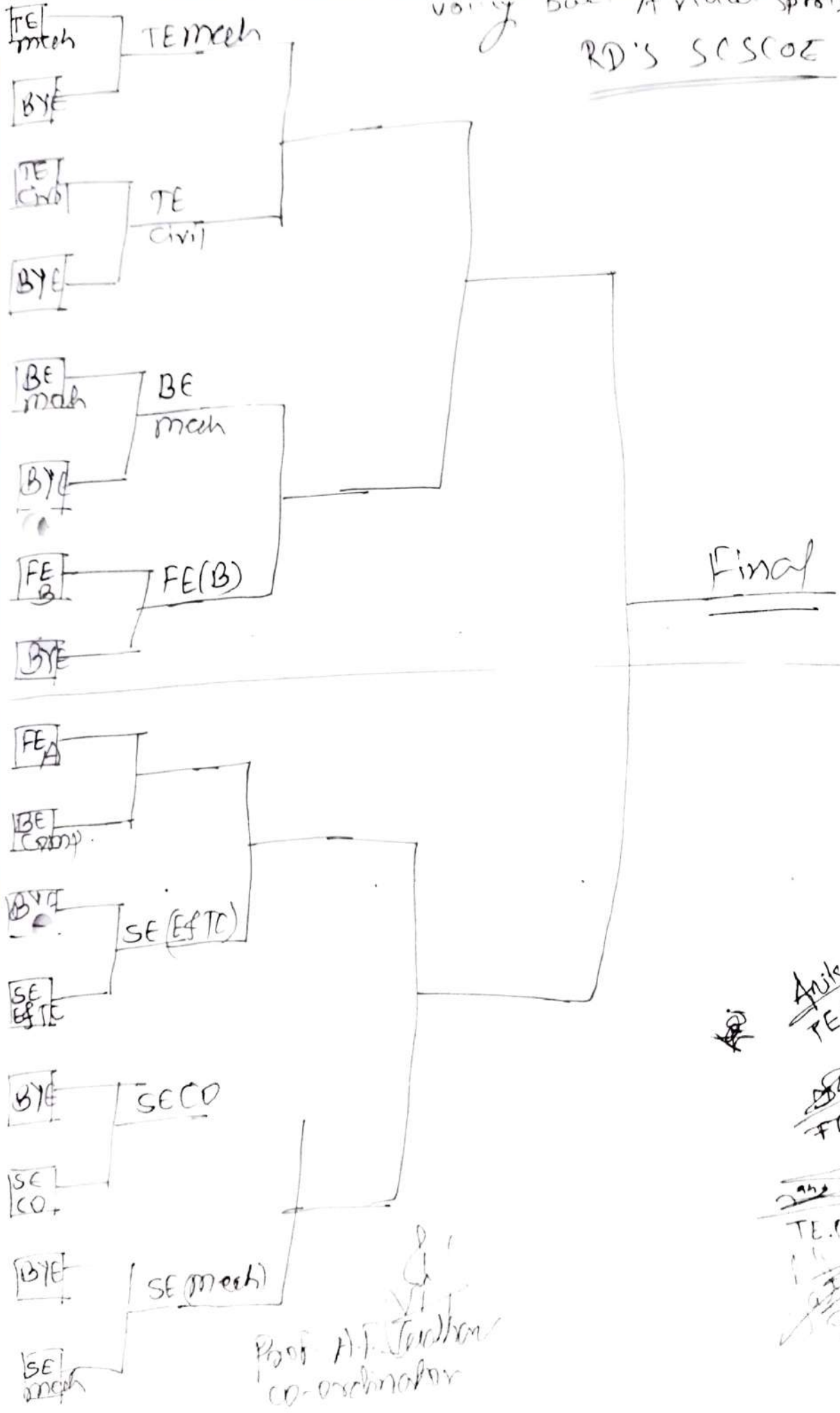

~~Arif~~  
 Arif  
 TE mech  
~~Arif~~  
 Arif  
 FE comp.  
~~Arif~~  
 Arif  
 TE Mech  
~~Arif~~  
 Arif  
 BE comp

Prof. A.F. Jadhav  
 co-ordinator



Rajgad Dnyanpeeth's

## SHRI CHHATRAPATI SHIVAJIRAJE COLLEGE OF ENGINEERING

S. No. 237, Satara-Pune, NH-4, Dhangawadi, Tal: Bhor, Dist: Pune -412205 (MS), India.

Website: [www.rajgad.edu.in](http://www.rajgad.edu.in), Email Id: [scscoe@gmail.com](mailto:scscoe@gmail.com)

### Annual Sports A. Y. 2022-23

Event Date:

Name of the Event: Running (100m) / Badminton / Chess / Carrom

Sr. No.	Name of student	Class & Branch	Contact number	Date of Birth	Sign
1	Atharva Dabholkar	T.E Mech	8830976195	1 <sup>st</sup>	1 <sup>st</sup>
2	Karan Yadav	T.E Mech.	9021969149		
3	Prasad Nalawade	-IT			
4	Shrinivas Dhame	-IT	726 2971633		
5	mayur walhekar	-IT	9172373919		
6	Tejas Kondalkar	B.E Mech	9923496361		
7	Shinde Dipak N.	T.E comp	9307992990		
8	Vaibhav Kshirsagar M.	T.E comp	9834808562		
9	Swaraj Rathod	B.E. comp	9511835139		
10	Solati Someswar	B.E comp	7028079359	2 <sup>nd</sup>	
11	GADE GAURAV	F.E. comp	8432658127	2 <sup>nd</sup>	
12	Jedhe Deep	F.E. EandTC	8329834073		
13	Bhosale Digvijay	F.E. mech	7385380799		
14	<del>Harsh</del> Ambike Atul	F.E E&TC	7499694241		

15 Shreeharsh Puntambekar SE

16 Sanket Chivhe

comp  
F.E Comp 9730249667

1<sup>st</sup>

2<sup>nd</sup>

Sports Co-ordinator

Sport Head

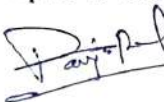
  
23/11/2023





Sports club – Academic Year 2022-23

Schedule: Day-1/2/3/4/5

Start Date: 0 /03/2022

**Name of Event: Kabaddi**

1. Match 1: Round 1: Time: 10.30 a:m Onwards

Team A	Vs	Team B
<b>SE Mechanical</b>		<b>BE Computer</b>

2. Match 2: Round 1

Team A	Vs	Team B
<b>FE.A</b>		<b>SE E&amp;TC</b>

3. Match 3: Round 1

Team A	Vs	Team B
<b>TE Mechanical</b>		<b>11<sup>th</sup> Science</b>

4. Match 4: Round 2

Team A	Vs	Team B
<b>SE Computer</b>		<b>FE.C</b>

5. Match 5: Round 2

Team A	Vs	Team B
<b>TE Civil</b>		<b>BE Civil</b>

6. Match 6: Round 2

Team A	Vs	Team B
<b>FE.B</b>		<b>Winner of 1<sup>st</sup> match</b>

7. Match 7: Round 2:

Team A	Vs	Team B
<b>Winner of 2<sup>nd</sup> match</b>		<b>Winner of 3<sup>rd</sup> match</b>

8. Match 8: Round 3 (Semifinal):

Team A	Vs	Team B
<b>Winner of 5<sup>th</sup> match</b>		<b>Winner of 6<sup>th</sup> match</b>

9. Match 9: Round 3(Semifinal):

Team A	Vs	Team B
<b>Winner of 7<sup>th</sup> match</b>		<b>Winner of 4<sup>th</sup> match</b>

10. Match 10: Round 4 (Final):

Team A	Vs	Team B
<b>Winner of 8<sup>th</sup> match</b>		<b>Winner of 9<sup>th</sup> match</b>

  
Sports coordinator  
prob. H.R. Kondaqunka

  
Sports Head  
(Prof. K.C. Ghole)

  
Estate manager

  
Principal

Kabaddi

Annual Sports → 2022-23

23/02/2023

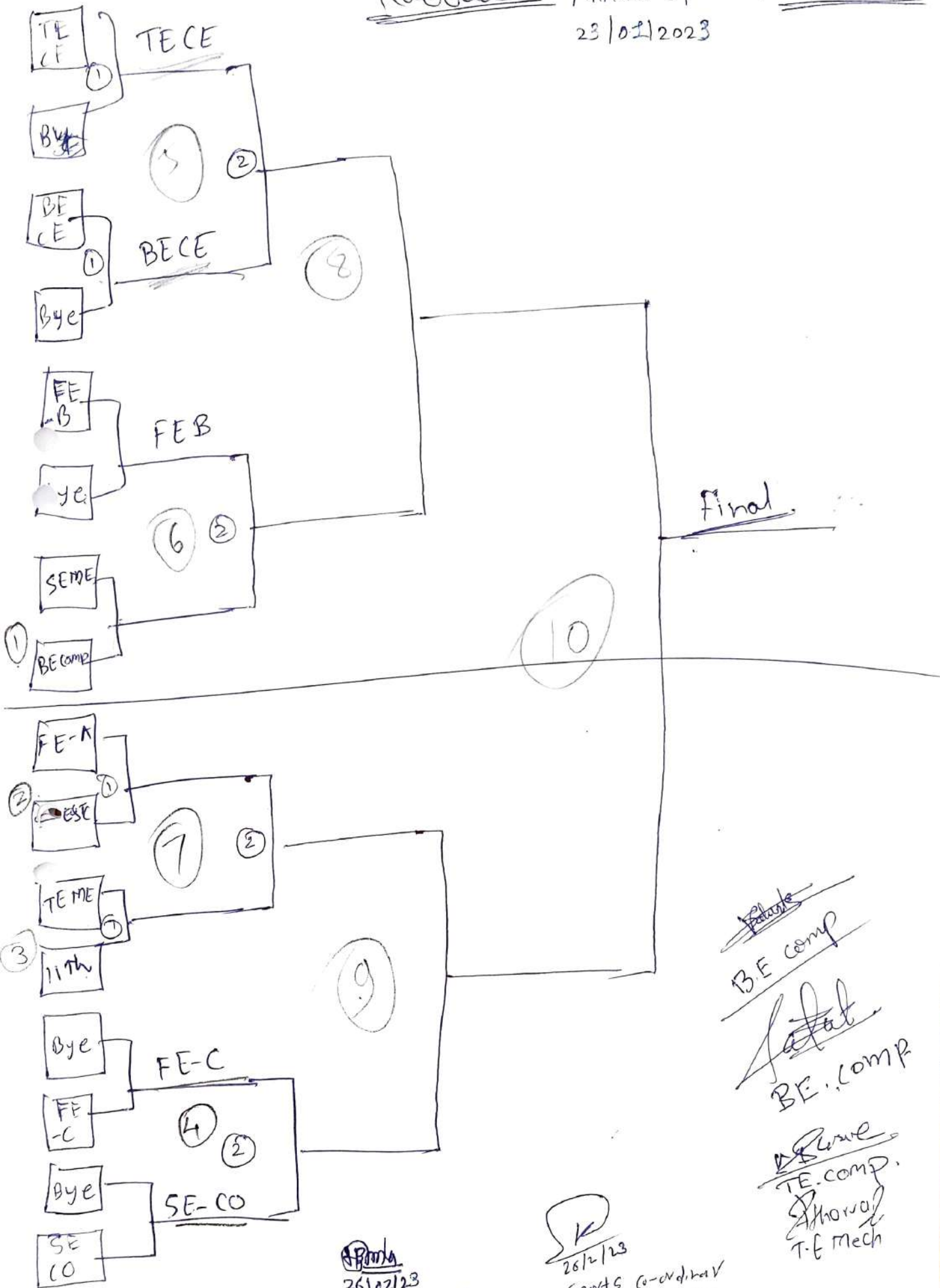

Final

~~BE comp~~  
BE comp  
~~TE comp~~  
TE comp  
~~T-E Mech~~  
T-E Mech

Himanshu  
 26/02/23  
 Himanshu Kondapur

SK  
 26/2/23  
 SPORTS co-ordinator  
 K.L. Gondalgaon



Sports club - Academic Year 2022-23

Schedule: Date-28/02/2022

Start Date: 23/01/2023.

Name of Event: Chess

Duration:

1. Board no 1: Round: 2

Player Name	Vs	Player Name
Meghasham Kapure		Mahajan Kaushal

2. Board no 2: Round: 2

Player Name	Vs	Player Name
Bhose Rameshwar		Khankar Vivek

3. Board no 3: Round: 2

Player Name	Vs	Player Name
Ganesh Pappal		Niranjan Bansode

4. Board no 4: Round: 2

Player Name	Vs	Player Name
Chavan Kunal Balasaheb		Shinde Dipak Naresh

5. Board no 5: Round: 2

Player Name	Vs	Player Name
Shinde Rashmi Ravindra		Sanika Maruti Bobade

6. Board no 6: Round: 2

Player Name	Vs	Player Name
Sanket Bhosle		Aniket Raut

P. J. Gaikwad  
27/1/23  
Sports coordinator

P. J. Gaikwad  
23/1/2023  
Sports Head

Estate manager

Principal



**Rajgad Dnyanpeeth's**  
**Shri Chhatrapati Shivajiraje College of Engineering, Dhangawadi**  
Approved by A.I.C.T.E- New Delhi, Recognized by Govt. of Maharashtra, Affiliated to Savitribai  
Phule Pune University, Pune

Sports club – Academic Year 2022-23

Schedule: Day-1/2/3/4/5

Start Date: 23/01/2023

**Name of Event: Carrom (Boys)**

1. Match 1: Round 1: Time: 10.30 a:m Onwards

Team A		Vs	Team B	
9284658551 7738597637	1. Sanket Bosale 2. Yash Jankar			1. Shreyas Motekar 2. Rohit Vishwakar

2. Match 2: Round 1:

Team A		Vs	Team B	
7397887475 8830712660	1. Atharv Pardehi 2. Atharv Male			1. Dhruv Patilkar 2. Giridhar Chinkar

3. Match 3: Round 1

Team A		Vs	Team B	
9703797648 717258696	1. Karan Rajwade 2. Aniket Rout			1. Suvarnil Pardehi 2. Vinay Jagtap

4. Match 4: Round 1

Team A		Vs	Team B	
7517049624 726409872	1. Mandar Shikhe 2. Arun Deshpande			1. Aniket Shinde 2. Aditya Tupe

5. Match 5: Round 2 (Semi Final)

Team A		Vs	Team B	
9370896060 9356967004	1. Kondhalkar Tejas. K 2. Prathmesh Gujar			1. Pujari Mahesh 2. Suyog Chodkerkar

6. Match 6: Round 2

Team A		Vs	Team B	
7756919181 9156798179	1. Swarnand Pothic 2. Aqib Shaikh			1. Vinayak Dhighe 2. Rushikesh Patilkar

7. Match 7: Round 3 (Final)

Team A		Vs	Team B	
9373810027 9359056350	1. Suyash Tagad 2. Eshwar Gopao			1. Khadkar Deepak 2. Bhosale Digvijay

Winners: 1.  
2.

Runner up: 1.  
2.

Sports coordinator

Sports Head

Estate manager

Principal





Rajgad Dnyanpeeth's

SHRI CHHATRAPATI SHIVAJIRAJE COLLEGE OF ENGINEERING

S. No. 237, Satara-Pune, NH-4, Dhangawadi, Tal: Bhor, Dist: Pune -412205 (MS), India

SPORTS CLUB – Academic year 2022-2023

## CHESS SCORE SHEET

ROUND : 2	DATE : 28/01/2023
DURATION: Start Time:	Location: seminal hall
End Time:	BOARD: 1 to 5

BOARD NO:	PLAYER'S NAME	WHITE POINTS	BLACK POINTS	WINNER POINTS
1	Kunal Chavan			✓ <u>Shakmate</u>
	Dipak Shinde			
2	Bansude Niranján		23	✓
	Ganesh Papal	9		
3	Meghsham Kapure	37		✓
	Mahajan Kaushel		13	
4	Bhore Rameshwar		28	✓
	Vivek Khamkar	10		
5	Sanika Bobade	7		✓
	Rashmi Shinde		4	

Winner Name: \_\_\_\_\_

Result:  white  Black  Draw

ARBITER

  
SPORT COORDINATOR

Final



Annual Sports 2022-23 CARROM SCORESHEET

TOURNAMENT Carrom  
EVENT ..... ROUND Final DATE ..... TIME .....  
MATCH NO. .... UMPIRE .....  
TOSS WON BY ..... CHOICE BY TOSS WINNER .....

Game No.	Starting Time	Finishing Time	Player's Name	Player's Name
1.			<u>Yash Ravi</u>	<u>Pratiksha Chavan</u>
2.			<u>Sakshi Salunke</u>	<u>Taithili Kothare</u>
3.			Team <u>White</u>	Team <u>Black</u>

Game No.	Board No.	1 Break By	2 Queen	3 No. of c/m	4 Grand Total	5 Queen	6 No. of c/m	7 Grand Total
1	1.			1			1	
	2.			1			1	
	3.			1			1	
	4.			1			1	
	5.			1			1	
	6.			X			1	
	7.							
	8.							

REMARK BY UMPIRE .....

WINNER NAME :

Taithili Kothare  
Pratiksha Chavan  
(BE Comp.)

SIGN OF WINNER :

Mattur . Rehane

SIGN OF LOSER :

Rehane

7448001538  
7057621972

ABJ  
23/11/2023





Sports club – Academic Year 2022-23

Schedule: Day-1/2/3/4/5

Start Date: 23/01/2023

Name of Event: Cricket

1. Match 1: Round 1: Time: 10.30 a:m Onwards

Team A	Vs	Team B
BE Civil		BE Mechanical

2. Match 2: Round 1

Team A	Vs	Team B
BE Computer		FE.A

3. Match 3: Round 1

Team A	Vs	Team B
TE Civil		TE Mechanical

4. Match 4: Round 1

Team A	Vs	Team B
SE Computer		FE.B

5. Match 5: Round 2

Team A	Vs	Team B
SE Mechanical		TE Computer

6. Match 6: Round 2

Team A	Vs	Team B
11 <sup>th</sup> Science		SE E&TC

7. Match 7: Round 2:

Team A	Vs	Team B
Winner of 1 <sup>st</sup> match		Winner of 4 <sup>th</sup> match

8. Match 8: Round 2

Team A	Vs	Team B
Winner of 2 <sup>nd</sup> match		Winner of 3 <sup>rd</sup> match

9. Match 9: Round 3 (Semifinal):

Team A	Vs	Team B
Winner of 5 <sup>th</sup> match		Winner of 8 <sup>th</sup> match

10. Match 10: Round 3 (Semifinal):

Team A	Vs	Team B
Winner of 6 <sup>th</sup> match		Winner of 7 <sup>th</sup> match

11. Match 11: Round 4 (Final):

Team A	Vs	Team B
Winner of 9 <sup>th</sup> match		Winner of 10 <sup>th</sup> match

  
Sports coordinator  
(Prof. S.D. Pasalkar)

  
Sports Head  
(Prof. K.C. Onkarsan)

  
Estate manager

  
Principal





Cricket  $\Rightarrow$  Coordinator

- ① Omkar Karande - TEMech  $\Rightarrow$  9022102613
- ② Atharva Dhobalkar - TEMech  $\Rightarrow$  8830976195
- ③ Soham Solat  $\Rightarrow$  BE Comp  $\Rightarrow$  9130210793
- ④ Adarsh Shinde  $\Rightarrow$  TEMech  $\Rightarrow$  9767433652
- ⑤  $\Rightarrow$  SE E&TC  $\Rightarrow$
- ⑥  $\Rightarrow$

1<sup>st</sup> rowt -

③ ~~3~~ overs: - full pitch 1 - 1 - 1

- ② wide - No - over throw - Run  $\rightarrow$
- ③ Hired Run out
- ④ 3 players ⑤ free hit  $\Rightarrow$  overstepping
- ⑥ Side ~~X~~ keep close - Back - change

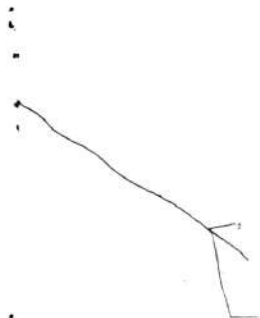



Rajgad Dnyanpeeth's  
**SHRI CHHATRAPATI SHIVAJIRAJE COLLEGE OF ENGINEERING**  
S. No. 237, Satara-Pune, NH-4, Dhangwadi, Tal: Bhore, Dist: Pune -412205 (MS), India.

## AnantMohotsav 2k23

Sr. No.	Day & Date	Event Detail
1	Monday, 23/01/2023 to Monday, 06/02/2023	11.00 am Indoor & Outdoor sports Inauguration (Cricket, Chess, Carom, Badminton, Volleyball, Throw ball, Kabbadi, Running)
2	Wednesday, 08/02/2023 to Monday, 13/02/2023	Days Celebration 08 <sup>th</sup> Feb Mismatch / Gown Day / Cooking Competition 09 <sup>th</sup> Feb Retro Day / Bollywood /Semi - Talent Competition 10 <sup>th</sup> Feb Saree / Ghagra / Tie Day 11 <sup>th</sup> Feb Black and White Day 13 <sup>th</sup> Feb Twins / Red / Signature Day
3	Monday, 13/02/2023	03.00 pm to 05.00 pm Cultural Program & Fish Ponds
4	Tuesday, 14/02/2023	11.00 am to 1.00 pm Mehandi & Tattoo Competition 02.00 pm to 4.00 pm Cap/ T-Shirt Painting & Photography (Inauguration & Competition)
5	Wednesday, 15/02/2023	11.00 am to 2.00 pm Rangoli (Inauguration & Competition) 02.00 pm to 04.00 pm and Art-Exhibition & Coin Collection
6	Friday, 17/02/2023	1.00 pm to 3.00 pm Lunch 4.00 pm to 11.00 pm Stall (Setup & Inauguration) 6.00 pm to 11.00 pm "Mudra" (Cultural Program)
7	Saturday, 18/02/2023	12.00 pm to 1.00 pm Alumni Meet : Venue- Seminar Hall 02.00 pm to 4.00 pm Prize Distribution function : Venue- Seminar Hall 06.00 pm to 11.00pm "Rajgad Karandak".
8	Sunday, 19/02/2023	10.00 am to 1.00 pm Shivjayanti Festival

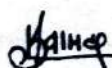
  
Prof. K. S. Khamkar, Prof. K. R. Juare

Cultural Secretary

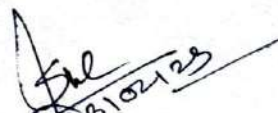
  
Mr. R. S. Khamkar

Estate Manager  
Estate Manager  
Rajgad Dnyanpeeth's Technical Campus  
DTE/324  
SPPU-4071  
Dhangawadi  
Pune  
412206



  
Prof. Dr. S. B. Patil

Principal

Principal  
Rajgad Dnyanpeeth's  
Shri Chhatrapati Shivajiraje College of Engg.  
Dhangawadi, Pune-412206



# 8•Fireless Cooking Competition



Rajgad Dnyanpeeth's

**SHRI CHHATRAPATI SHIVAJIRAJE COLLEGE OF ENGINEERING**

Gat No. 237, Pune Bangalore Highway, Dhangawadi, Tal – Bhore, Dist- Pune (Maharashtra)

## REPORT ON FIRELESS COOKING COMPETITION – 2023

**DEPARTMENT:** All

**TITLE/TOPIC:** Fireless Cooking Competition - 2023

**DAY & DATE:** Wednesday, 08/02/2023      **DURATION OF EVENT:** 02.00 pm to 05.00 pm.

**STUDENT/STAFF PRESENT:** 50 / 25      **CO-ORDINATOR:** Prof. K. S. Khamkar

Prof. K. R. Juare

**OBJECTIVE:** To create awareness about the nutritional value of food cooked without flame, the necessity and advantages of healthy eating and to encourage everyone to stay away from the junk food.

### DESCRIPTION:

Students of Rajgad Dnyanpeeth's SCSCOE, Dhangwadi donned their 'Chef Caps' to exhibit their culinary skills in 'Cooking without Fire' Inter College competition held on 08th Feb 2023. Students participated with full zeal and enthusiasm as they doled out nutritious yet delectable delicacies selected post exhaustive research on the cultural backgrounds of the relevant recipes. Artifacts and food items displayed were a visual treat and were presented in an artistic and aesthetic style.

Dishes were judged on nutrition and taste by esteemed judges Prof. D. A. More, Mrs. Dixit, Prof. S. B. Shirke and Prof. S. Jagtap. They interacted with the budding chefs to find out the ingredients of the recipes, nutritional value and the historical significance of the dishes prepared by them. Judges were overawed by the efforts of the participants and results were announced. First position was secured by Gauri More & Snehal Pisal closely followed by Devkar Poonam & Komal Walhekar which bagged the second position. The third position was shared by Lambe Durgesh & Vivek Jagtap and Kartik Karne & Pratibha Pawar.

The occasion was blessed with the presence of Prof. Dr. S. B. Patil (Principal, SCSCOE), Mr. R. S. Khamkar (Estate Manager, Rajgad Dnyanpeeth's) and all department HOD's, other Teaching, Non-teaching faculty of the college. The event was coordinated by Prof. K. S. Khamkar and Prof. K. R. Juare with support of members of cooking competition team.





**CONCLUSION:** The event not only provided a platform for the students to foster their creativity and decision making skills but also helped them explore their hidden talents and discover new areas of interest.



**Fireless Cooking Competition – 2k23**



**Student preparing their dish for competition**



**Judges interaction with participants**



**First Winner of Competition**

  
Prof. K. S. Khamkar, Prof. K. R. Juare  
**Cultural Coordinator**



  
Prof. Dr. S. B. Patil  
**Principal**

**PRINCIPAL**  
Rajgad Dnyanpeeth's  
Shivaji Maharaj Shiksha Chakra, Shivajiraje College of Engg.  
Dhangawadi, Bhor, Pune-412206





Rajgad Dnyanpeeth's  
**SHRI CHHATRAPATI SHIVAJIRAJE COLLEGE OF ENGINEERING**  
S. No. 237, Satara-Pune, NH-4, Dhangwadi, Tal: Bhor, Dist: Pune -412205 (MS), India.

---

**Date: 02/02/2023**

## **FIRELESS COOKING COMPETITION: 2022-23**

Even though we're growing up, we should never stop having fun. Fun comes in anything and everything....be it cooking or relishing sumptuous eats!!!!

As a part of The Days Celebration – 2022-2023, Rajgad Dnyanpeeth's Technical Campus, Dhangwadi, Pune announce, "Fireless Cooking Competition" for all degree and diploma students. The students are requested to register their names or groups with following faculties of their department:

Prof. B. R. Bhatti (Computer)

Prof. N. D. Bagul (Mechanical)

Prof. R. R. Zende (E&TC)

Prof. K. R. Juare (Civil)

### **The details of the competition are as follows:**

1. Registration: Last date 07/02/2023
2. Competition date: 08/02/2023
3. Venue: RDTC, Seminar Hall
4. Time: 2pm – 4pm

**General Instructions:**

1. Students will have to bring the required ingredients from home.
2. One team may contain maximum 2 members.
3. The theme for the cooking is no fire recipes.
4. Ready-made decorative items are not permitted.
5. Cutting of vegetables and/or fruits should be done on the spot. No prior preparation allowed.
6. Each group will get one hour for preparation & presentation.
7. One vegetable craft may be done along with the main item. This contains additional point.

**Judgment Criterion:**

1. Menu/Recipe composition/Innovation
2. Cleanliness during preparation
3. Arrangement and Presentation- team work
4. Flavor of the dish



Prof. K. S. Khamkar, Prof. K. R. Juare

**Cultural Coordinator**

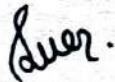

Mr. R. S. Khamkar

**Estate Manager**  
**Estate Manager**

Rajgad Dnyanpeeth Technical Campus  
Dhangawadi, Pune-412205.





Prof. Dr. S. B. Patil

**Principal**

**Principal**  
Rajgad Dnyanpeeth's  
Shri Chhatrapati Shivaji College of Engg.,  
Dhangawadi, Pune-412206





Rajgad Dnyanpeeth's  
Shri Chhatrapati Shivajiraje College of Engineering  
S.No 237, NH-4, Dhangawadi, Tal.Bhor, Dist.Pune

Date : 08/02/2023

Attendance for Cooking Competition

Sr. No.	Name of Student	Class	Sign
1	More Gnani P.	BE CIVIL	
	Pisal Snehal C	BE CIVIL	
2	Pisal Sanika	TE Mech	
3	Deshmukh Sanika	TE comp	
4	Dudhane Tejas	BE E&TC	
	Salunke Pratibha	BE E&TC	
5	Pannam Daykar	BE E&TC	
	Komal Wathekar	BE E&TC	
6	Lambe Durgesh	TE CIVIL	
	Vivek Jagtap	TE CIVIL	
7	Karme Karthik	TE CIVIL	
	Paunar Pratibha	TE CIVIL	
8	Gudgude Shrawani	SE Comp	
	Dhosale Shreya	SE comp	
9	Andhalikar Akshata	SE COMP&E&TC	
	Chavan Simran	SE CIVIL	
10	<del>Shreya Bhalke</del> Shreya Bhalke	BE Comp	
	Shreya Bhalke	BE comp	
11	Aditya shinde	EE comp	
	vazeal hillal	EE comp	
12			
13			
14			

Name & Sign of Cultural Coordinator  
(Prof. K. S. Khemkar)





Rajgad Dnyanpeeth's  
**Shri Chhatrapati Shivajiraje College of Engineering**

S.No 237, NH-4, Dhangawadi, Tal.Bhor, Dist.Pune

Academic Year : 2022-23

**Fireless Cooking Competition**

Sr. No	Group No.	Name of Student	Receipe Name	Marks				
				Menu (10)	Cleanliness During Performance (10)	Presentation (10)	Flavor of the Dish (10)	Total (40)
1	01	More Gauri P.	Cheese SD. Bun	9	9	7	9	36
2		Pisal Snehal C	Di Rauta, Chat					
3	02	Pisal Sanika	Brade donut	7	8	7	6	28
4			Lays Chat					
5	03	Deshmukh Sanika	Pineapple lussi	6	7	6	6	25
6			Nachho Chat					
7	04	Salunkhe Pratiksba	Mojito	6	6	6	6	24
8			Dudhane Tejas					
9	05	Devkar Pooam	Chocolate ball	8	9	8	8	33
10			Komal Walebekar	with biscuit SD				
11	06	Lambe Durgesh	Jungle juice	8	8	8	7	31
12			Vivek Jagtap	(mojito)				
13	07	Kartik Sarne	Snowman	8	7	8	8	31
14			Pratibha Pawar					
15	08	Budgude Shrawani	Rhel Straws	7	7	7	7	28
16			Shreya Bhosale					
17	09	Aradhakar Akshata	Chips Chat	6	7	7	8	28
18			Simran Chavhan					



I

II

III



19	10	Shreyas Bhalke	Khalsa Purbi	7	7	8	2	30
20								
21	11	Aditya Shinde	Pinwheel	7	7	7	8	29
22		Vardh Nihal	Sandwich					
23								
24								
25								
26								
27								
28								
29								
30								
31								
32								
33								
34								

  
 Name and Sign of Judge  
 (Ewirke S.B) (More D.A).

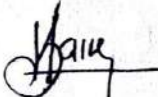
  
 Name & Sign of Cultural Coordinator  
 (K. S. Khumkar)



Rajgad Dnyanpeeth's  
**Shri Chhatrapati Shivajiraje College of Engineering**

S.No 237, NH-4, Dhangawadi, Tal.Bhor, Dist.Pune

Academic Year : 2022-23

**Fireless Cooking Competition**

Sr. No	Group No.	Name of Student	Receipe Name	Marks					
				Menu (10)	Cleanliness During Performance (10)	Presentation (10)	Flavor of the Dish (10)	Total (40)	
1	01	Mate Gauri Pravin	Cheese Sand-	05	09	09	09	36	-1
2		Pisal Snehal C.	witch, Bunditopp						
3	02	Pisal Sanika	Brade donut	07	08	7	6	28	
4									
5	03	Deshmukh sanika	Pineapple lussi	06	07	06	06	25	
6			Nachhochat						
7	04	Salukhe Pratiksha	Mogito	06	06	06	06	24	
8		Pudhane Tejas							
9	05	Derkar Poonam	Chocolate ball	08	09	07	08	32	-2
10		Kamal Walbekar	with biscuit						
11	06	Lambe Durgesh	Jungle juice	08	08	08	09	33	-3
12		Vivek Jagtap							
13	07	Kantik Karme	Gnaw man	08	07	08	08	31	
14		Pratibha Pawar							
15	08	Budgude Shrawani	Bhel Shots	07	07	07	07	28	
16		Shreyas Bhosale							
17	09	Anchalika Akshata	Chips Chat	07	07	08	08	28	
18		Simran Chanin							

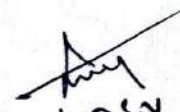

19	10	Shreya Shelke	Kharva band	07	07	08	08	30
20								
21	11	Aditya Shinde	Pingulheer	07	08	07	07	29
22		Vansod hill a/	90					
23								
24								
25								
26								
27								
28								
29								
30								
31								
32								
33								
34								

  
Mr. Jaytap S.V.

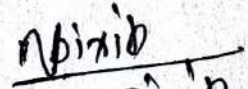
  
Mrs. N. D. Dixit  
Name and Sign of Judge

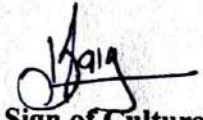
  
Name & Sign of Cultural Coordinator  
(Prof. K. S. Kheurkar)

# 9-Photography Competition

SCSCOE / ACAD / AF / 04 Rev 01



RajgadDnyanpeeth's  
**SHRI CHHATRAPATI SHIVAJIRAJE COLLEGE OF ENGINEERING**  
S. No. 237, Satara-Pune, NH-4, Dhangawadi, Tal: Bhor, Dist: Pune

Date- 10/02/2023

## PHOTOGRAPHY COMPETITION 2022-23

### NOTICE

All the students of RD'S are hereby informed that, the college is going to organized "Photography Competition" on 14<sup>th</sup> Feb 2023 at 02:00 pm To 04:00 pm The interested students take part in the competition must give yours name to the Photography Competition Coordinator.

### Rules for Photography Competition on the 14th Feb 2023

1. All entries must be high-resolution digital images
2. Photo may be black & white or color.
3. One participant submits maximum 4 photographs.
4. Size of Photographs is 4 x 6 inch (10.2 x 15.2cm).
5. Photographs should be paste on white/color card sheet.
6. Multiple entries by one person are not allowed.
7. Submitted photos must be original, created and/or taken by the contestant.

### Contact to Competition Coordinator (Civil Engineering Department)

- Prof. R. C. Divekar. (9022527161)
- Prof. S. S. Jadhav. (7249600103)

  
Prof. S. S. Jadhav & Prof. R. C. Divekar

Coordinator

  
Prof. K. S. Khamkar. & Prof. K. R. Juare.

Cultural Coordinator

  
Dr. S. B. Patil

Principal  
Rajgad Dnyanpeeth's  
Shri Chhatrapati Shivajiraje College of Engg.,  
Dhangawadi, Pune-412206







RajgadDnyanpeeth's  
**SHRI CHHATRAPATI SHIVAJIRAJE COLLEGE OF ENGINEERING**  
S. No. 237, Satara-Pune, NH-4, Dhangawadi, Tal: Bhor, Dist: Pune

**Date: 11/02/2023**

**Registration Sheet for Photography Competition on the  
Occasion of ANANT MOHOTSAV 2K23**

Sr. No	Name of Participant	Class	Mail id	Contact Number
1)	Pisal Ganika Narayan	T.E mech		7841886959
2)	Deshmukh Sunika Patil	T.E. Comp		9322736256
3)	Jain Ketan Narendrakumar	B.E Civil		9175055874
4)	Budgude shruvanee	S.E. Comp		9689368836
5)	Puntambekar Shreeharsh	TE Comp		8378053519
6)	Shahane Mandar	TE Comp		8888551730
7)	Pujari Mahesh	TE Comp		9356967004
8)	Khirsagar Saursabh	BE Civil		7038619661
9)	Rajiwade Ketan	TE Civil	Ketanrajiwade@gmail.com	9004095707
10)	Jamdhade Sanket P.	BE Civil	sanketjamdade13@gmail.com	9960292913
11)	Kendre Sunath	TE civil	Skendre916@gmail.com	9284611493
12)	Durgesh .V. Lambe	TE. civil	Lambe durgesh 143@gmail.com	7888238383
13)				

**Event Co-ordinator**

**Principal**



Prof. Dr. Sanjay B. Patil  
Principal  
Shri Chhatrapati Shivajiraje College of Engg.  
Dhangawadi, Pune-412305







MS/SGE / AEAD / CP / BL / WP / 2

**Rajgad Dnyanpeeth's**  
**SHRI CHHATRAPATI SHIVAJIRAJE COLLEGE OF ENGINEERING**  
S. No. 237, Satara-Pune, NH-4, Dhanganwadi, Tal: Bhor, Dist: Pune -412205 (MS), India.

**Result of Photography Competition Event 2k23**

Sr. No.	Name of Student	Branch	Rank
1	Sanika Narayan Pisal	Mechanical	I
2	Shravanee Navnath Budgude	Computer	II

  
Event Co-ordinator

  
Principal  
Prof. Dr. Sanjay B. Patil  
Shri Chhatrapati Shivajiraje College of Engg.  
Dhanganwadi, Pune-412205.



Sign of Faculty: \_\_\_\_\_

## REPORT ON PHOTOGRAPHY COMPETITION – 2023

**DEPARTMENT:** All

**TITLE/TOPIC:** Photography Competition - 2023

**DAY & DATE:** Wednesday, 14/02/2023

**DURATION OF EVENT:** 02.00 pm to 04.00pm.

**STUDENT/STAFF PRESENT:** 10/25

**CO-ORDINATOR:** Prof. S. S. Jadhav

Prof. R. C. Divekar

**OBJECTIVE:** To communicate and document moments in time is the purpose of photography. Photography creates memories and preserves special moments in life, it teaches history, it inspires to live life more, builds connections. Photography is also important for business marketing.

### DESCRIPTION:

Photography Competition was organized at Rajgad Dnyanpeeth Technical Campus for all students of Diploma, Degree and Jr. College on 14<sup>th</sup> Feb 2023. Photography is pursued as a hobby or for business purposes.

Competition was judged Prof. S.P.Salunkhe who has very good photographic sense. She interacted with the participants regarding the perspective of captured photograph.. Judges were overawed by the efforts of the participants and results were announced. Prize was secured by Sanika Pisal & Shravani Budgude.

The occasion was blessed with the presence of Prof. Dr. S. B. Patil (Principal, SCSCOE), Mr. R. S. Khamkar (Estate Manager, Rajgad Dnyanpeeth's) and all department HOD's, other Teaching, Non-teaching faculty of the college. The event was coordinated by Prof. K. S. Khamkar and Prof. K. R. Juare with support of members of Photography competition team.

**CONCLUSION:** Photography is a hobby anyone can do. Age, race, and gender won't limit you from enjoying the benefits of photography. Also, you don't need an expensive camera, as a phone camera works. Photography is all about perspective of individual.







Photography Competition – 2k23



Photographs of Competition

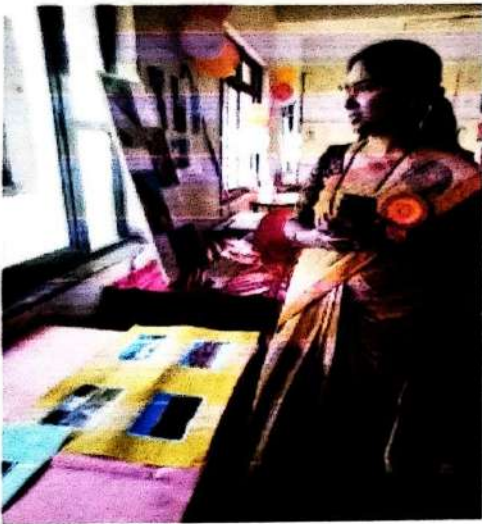

Guest Observe the Photographs



Winner photos of the Photography

Prof. S. S. Jadhav, Prof. R. C. Divekar,

Event Coordinator

Prof. K. S. Khamkar, Prof. K. R. Juare

Cultural Coordinator

Dr. S. B. Patil

Principal

Rajgad Dnyanesh's  
Shri Chhatrapati Shivaji Maharaj College of Engg.,  
Erandawadi, Pune-412 205





Rajgad Dnyanpeeth's  
**SHRI CHHATRAPATI SHIVAJIRAJE COLLEGE OF ENGINEERING**  
S. No. 237, Satara-Pune, NH-4, Dhangawadi, Tal: Bhore, Dist: Pune -412205 (MS), India

Ref. no./RD/SCSCOE/Notice/2022-23

Date: 10/02/2023

## **ART EXHIBITION: 2022-23** **NOTICE**

All the students of RD's are hereby informed that, the college is going to organize Art -Exhibition on **February 15, 2023 at 2:00 pm to 4:00 pm** & the Exhibition venue is **Classroom next to Seminar Hall**. The interested students to take part in the Exhibition must register your names and Submit your Art/Craft Works to Art -Exhibition coordinator up to **Monday, 13 February, 2023**.

### **Note**

1. Previous made paintings, Sketches and Hand- crafts are permitted and those students will get only participation certificates.
2. Contacts of Art -Exhibition coordinator
  - Prof. A. D. Gole - 9172198645
  - Prof. S. M. Jadhav - 9730044095
  - Prof. A. R. Bobade - 8796170172

**Incase of any Queries, Contact to respective Art-Exhibition Coordinator.**

  
**Event coordinator**

  
**Cultural Coordinator**

  
**Principal**



  
Rajgad Dnyanpeeth's  
Shri Chhatrapati Shivajiraje College of Engg.,  
Dhangawadi, Pune-412206





RajgadDnyanpeeth's  
**SHRI CHHATRAPATI SHIVAJIRAJE COLLEGE OF ENGINEERING**  
S. No. 237, Satara-Pune, NH-4, Dhangawadi, Tal: Bhore, Dist: Pune

Date: 15/02/2023

Registration Sheet for Art Exhibition on the Occasion of  
**ANANT MOHOTSAV 2K23**

Sr. No	Name of Participant	Class	Mail id	Contact Number
1.	Vaibhavi Mahadik. (Drawing & Poem)	F. E - B (comp)	vaibhavi.mahadik.2004@gmail.com	7028121252
2.	Jagtap Ashvini (Drawing)	F. E - B (E & TC)	shrinathjagtap03@gmail.com	8080025838
3.	Malwatkar Pratiksha. (Drawing & Craftwork)	F. E - B (E & TC)	edurushit@gmail.com	8485088288
4.	Tanushri Zanje. (Drawing - 5)	11th	Tanushrizanje@gmail.com	7499351778
5.	Dyaneshwari Chavan (Drawing)	11th	Dyaneshwari.Chavan@gmail.com	9604864190
6.	Bhosale Sayali (Sketches + Paintings) - 9	T. E (comp)	bhosayali2@gmail.com	9665295413
7.	Jankar Tejaswini & Salve Sakita (Craft work)	T. E (comp)	Tejaswini.jankar.911@gmail.com	7249033513
8.	Raut Pooja 11 (Sketches - 10)	B. E (comp)	rpraut2001@gmail.com	9372457334
9.	Nikita Dhamal (Sketches - 12)	T. E (comp)	nikitadhamal26@gmail.com	9673690946
10.	Smita Reddy (Sketches - 10)	T. E (E & TC)	reddysmita01@gmail.com	9503583491
11.	Sakshi Zanje (Craftwork - 2)	11th	sakshizanje.205@gmail.com	9890887371
12.	Dyanraj Chavan (Drawing)	B. E (Mech)		7447813210

*Asale*

**Event  
Coordinator**

*Vijay*

**Cultural  
Coordinator**

*Arong*  
**Guest  
Judges**

*Chh*

**Principal**

RajgadDnyanpeeth's  
Shri Chhatrapati Shivajiraje College of Engg.,  
Dhangawadi, Pune-412206







Rajgad Dnyanpeeth's  
**SHRI CHHATRAPATI SHIVAJIRAJE COLLEGE OF ENGINEERING**  
S. No. 237, Satara-Pune, NH-4, Dhangawadi, Tal: Bhor, Dist: Pune

Date: 15/02/2023

**Evaluation Sheet for Art Exhibition on the  
Occasion of ANANT MOHOTSAV 2k23**

Sr. No.	Name of Participant	Criteria			Total Marks	Rank
		Neatness (10)	creativity (10)	colour/shading (10)		
1.	Voibhavi Mahadik [ F.E ] (Drawing & Poem) [ comp ]	8	9	8	25	
2.	Jagtap Ashwini [ F.E ] (Drawing) [ E & TC ]	8	8	7	23	
3.	Malvatkar Pratiksha [ F.E ] (Drawing & Craftwork) [ E & TC ]	8	9	8	25	
4.	Tanvi zanje [ 11 <sup>th</sup> ] (Drawing - 5)	9	9	7	25	
5.	Nikita Dhamal [ T.E ] (Sketches - 12) [ comp ]	9	9	8	26	3 <sup>rd</sup>
6.	Dyaneshwari chavan [ 11 <sup>th</sup> ] (Drawing)	9	8	8	25	
7.	Bhosale Sayali [ T.E comp ] (Sketches + Painting - 9)	8	8	8	24	
8.	Jankar Tejaswini & Salvi Sankita (Craft work) [ T.E comp ]	8	8	9	25	
9.	Raut Pooja [ B.E ] (Sketches - 11) [ comp ]	10	8	7	25	
10.	Smita Reddy [ T.E ] (Sketches - 10) [ E & TC ]	9	10	8	27	2 <sup>nd</sup>
11.	Sakshi zanje [ 11 <sup>th</sup> ] (Craftwork - 2)	8	8	7	24	
12.	Dyantaaj chavan [ B.E ] (Drawing) [ mech ]	8	7	7	22	
13.	Durgesh Lambe [ T.E ] (Drawing - 2) [ Civil ]	8	8	8	25	
14.	Arya Bandal [ F.E ] (Drawing - 5) [ E & TC ]	10	9	9	28	1 <sup>st</sup>

  
Event  
Coordinator

  
Cultural  
Coordinator

  
Guest  
Judges

  
Principal  
Principal  
Rajgad Dnyanpeeth's  
Shri Chhatrapati Shivaji Raje College of Engg.,  
Dhangawadi, Pune-412266





Rajgad Dnyanpeeth's  
**SHRI CHHATRAPATI SHIVAJIRAJE COLLEGE OF ENGINEERING**  
S. No. 237, Satara-Pune, NH-4, Dhangawadi, Tal: Bhor, Dist: Pune

**ANANT MOHOTSAV**  
**ART EXHIBITION-2022-23 WINNER LIST**

Sr. No.	Name of Event	Name of Student	Rank
1.	Art-Exhibition	Bandal Arya	1 <sup>st</sup>
2.		Reddy Smita	2 <sup>nd</sup>
3.		Dhamal Nikita	3 <sup>rd</sup>

  
Prof. A. D. Gole  
EVENT CO-ORDINATOR

  
Prof. K. S. Khamkar & Prof. K. R. Juare  
CULTURAL CO-ORDINATOR

  
Prof. Dr. S. B. Patil  
PRINCIPAL  
Principal  
Rajgad Dnyanpeeth's  
Shri Chhatrapati Shivajiraje College of Engg.,  
Dhangawadi, Pune-412206



**REPORT ON ART EXHIBITION : 2022-23**

**DEPARTMENT:** All

**TITLE/TOPIC:** ART EXHIBITION -2022-23

**DAY & DATE:** Wednesday,15/02/2023

**DURATION OF EVENT:** 02.00 pm to 04.00 pm.

**STUDENT/STAFF PRESENT:** 14/40

**OBJECTIVE:**To encourage students to build their skill & attractions towards Art.

**DESCRIPTION:**

Students of Rajgad Dnyanpeeth's SCSCOE, Dhangwadi arranged art exhibition for their artist to exhibit their drawing, painting & sketching skills in 'Art Exhibition' Inter College competition held on 14/03/2023. Students participated with submitting their old arts such as paintings, Drawings & sketches.

Exhibition were judged on Theme, Colour Combination & neatness of art by esteemed judges Mrs. Ashwinitai Bhong( Sub- Divisional Van Officer, Bhore). They interacted with the students & tried to know the theme of drawing by them. Judges were overawed by the efforts of the participants and results were announced. First position was secured by Arya Bandalof FE student.

The occasion was blessed with the presence of Prof.Dr. S. B. Patil (Principal, SCSCOE), Mr. R. S. Khamkar(Estate Manager, Rajgad Dnyanpeeth's) and all department HOD's, other Teaching, Non-teaching faculty of the college. The event was coordinated by Prof.K. S. Khamkar and Prof. K. R. Juare with support of members of Art Exhibition team Prof. A. D. Gole, Prof. S. M. Jadhav, Prof. A. R. Bobade.

**CONCLUSION:**The event not only provided a platform for the students to foster their creativity and decision making skills but also helped them explore their hidden talents and discover new areas of interest.



**Photos during event:**



**Felicitation of Chief Guest**

**Inauguration of Arts Exhibition**



**Crafts presented by Students**

**Evaluation of arts & Crafts by Guest**



**Art Wall of Art exhibition 2k23**





Staffs of SCSCOE at ART EXHIBITION 2K23 with chief Guest

*A. R. Bobade*  
Prof. A. R. Bobade  
**PREPARED BY**

*K. S. Khamkar*      *K. R. Juare*  
Prof. K. S. Khamkar & Prof. K. R. Juare  
**CULTURAL CO-ORDINATOR**

*S. B. Patil*  
Prof. Dr. S. B. Patil  
**PRINCIPAL**  
Principal  
Rajgad Dnyanpeeth's  
Chhatrapati Shivaji Maharaj College of Engg  
Dhangawadi, Pune-412206





RajgadDnyanpeeth's  
**SHRI CHHATRAPATI SHIVAJIRAJE COLLEGE OF ENGINEERING**  
S. No. 237, Satara-Pune, NH-4, Dhangawadi, Tal: Bhor, Dist: Pune -412205 (MS), India

Ref. no./RD/SCSCOE/Notice/2022-23

Date: 10/02/2023

## CULTURAL NOTICE

All the students of Rajgad Dnyanpeeth'S are hereby informed that, the college is going to organize Rangoli Competition on **February 15, 2023 at 11:00 am 2:00 pm** & the competition venue is **Seminar Hall**. Interested students who want to participate in the Rangoli competition must give their names to competition coordinator till 14<sup>th</sup> February 2023 only.

### Note

1. The required material for competition carry yourself.
  2. Rangoli designs not allowed to copy from google images / any other sources.
  3. Competition head will give final decision on the basis of competition criteria.
  4. For any query contact to Competition coordinator.
- **Prof. S. K. Bhosale - 7709552028**
  - **Prof. R. S. Nipanikar - 9130174183**
  - **Prof. R. R. Zende- 9881891498**



**Event coordinator**



**Cultural Coordinator**



**Principal**

**Principal**  
Rajgad Dnyanpeeth's  
Shri Chhatrapati Shivajiraje College of Engg.,  
Dhangawadi, Pune-412206







Rajgad Dnyanpeeth's  
**SHRI CHHATRAPATI SHIVAJIRAJE COLLEGE OF ENGINEERING**  
S. No. 237, Satara-Pune, NH-4, Dhangawadi, Tal: Bhor, Dist: Pune

Date: 14/02/2023

Registration Sheet for Rangoli Competition on the  
Occasion of ANANT MOHOTSAV 2023

Sr. No	Group Number	Name of Participant	Class	Email id	Contact Number
1	1	1] Sanika Pisal 2] Sanika Deshmukh	TE mech TE Comp	SanikaPisal222@gmail.com	7841886959
2.	2.	1] Snehal Pisal 2] Pooja Bhandalkar 3] Sayali Pawar	BE civil	snehalpisd5959@gmail.com	7249177606
3.	3.	1] Rutuja Kale 2] Gauri more	BE civil	moregauri51@gmail.com	9146778714
4.	4.	1] Gayatri Ganeshkar 2] Rashmi Shinde	TE Comp	GayatriGaneshkar0810@gmail.com	9146732703
5.	5.	1] Arya Bandal	FE	aryabandal257@gmail.com	9579490508
6.	6.	1] Asmita Bandal	FE	asmitabandal05@gmail.com	9699199240
7.	7.	1] Shreya Bhelake	BE Comp	shreyabhelake6@gmail.com	7972023866
8.	8.	1] Vaibhav Lokhande 2] Vaibhav Kadam 3] Omkar Karande	BE civil BE mech	Karandeomkar984@gmail.com	8080586491
9.	9.	1] Vaishnavi Ve 2] Rutuja Maragaje	SE ETC	Rutumaragaje@gmail.com	9307911917
10.	10.	1] Vaishnavi Vedpathak 2] Rupa jadhav 3] Bhagyashri Khopade	TE Comp	Rupajadhav1106@gmail.com	8551998855
11.	11.	1] Sakshi Salunkhe 2] Sejal Dhamal 3] Shreya Tanpure	TE Comp	snehatanpure19@gmail.com	9021578233
12.	12.	1] Jarrad Devyani 2] Vaishnavi Kadam 3] Omkar Pednekar	TE Comp BE mech	devyanijarrad07@gmail.com	7071299696
13.	13.	1] Abhinav Valhekar 2] Vaishnavi Patil 3] Akash Pandit	BE Comp	AbhiValhekar73@gmail.com	8856069996

*Rohini Bhosale P-zende*  
Event Co-ordinator  
R.S. Nipaniakar/  
S.K. Bhosale/  
R.R. Zende



*[Signature]*  
Principal  
Principal

Rajgad Dnyanpeeth Technical Campus  
Shri Chhatrapati Shivajiraje College of Engineering  
Dhangawadi, Bhor, Pune-412 205









Rajgad Dnyanpeeth's  
**SHRI CHHATRAPATI SHIVAJIRAJE COLLEGE OF ENGINEERING**  
Gat No. 237, Pune Bangalore Highway, Dhangawadi, Tal – Bhor, Dist- Pune (Maharashtra)

### REPORT ON RANGOLI COMPETITION – 2023

**DEPARTMENT:** All

**TITLE/TOPIC:** Rangoli Competition - 2023

**DAY & DATE:** Wednesday, 15/02/2023

**DURATION OF EVENT:** 11.00 am to 02.00 pm.

**STUDENT/STAFF PRESENT:** 36 / 15

**CO-ORDINATOR:** Prof. S. K. Bhosale

Prof. R. S. Nipanikar

Prof. R. R. Zende

**OBJECTIVE:** To learn about the appreciate, and feel pride in one's culture. Such events also encourage a sense of unity and harmony among the different cultures, art forms, and traditions of our country

#### DESCRIPTION:

Students of Rajgad Dnyanpeeth's SCSCOE, Dhangwadi donned their 'Rangoli to exhibit their folk art skills in 'Rangoli with colours and other decorative material.' Inter College competition held on 15<sup>th</sup> February 2023. Students participated with full zeal and enthusiasm as they selected Rangoli theme Designs on the cultural backgrounds of the relevant topics.

Rangoli were judged on Theme, Design Colour Combination & by esteemed Judges Prof. K. S. Khamkar, Prof. S. P. Salunkhe , Mrs. V. D. Dixit. They interacted with the participants to find out the how to make the Rangoli, which colour combination used for design prepared by them. Judges were overawed by the efforts of the participants and results were announced. First position was secured by Shivtare Harshada, Raut Pooja & Dhadve Pragati closely followed by Sanika Pisal ,Sanika Deshmukh & Gayatri Ganeshkar Rashmi Shinde which bagged the second position. The third position was secured by Snehal Pisal ,Pooja Bhandalkar ,Sayali Pawar & Vaishnavi Vedpathak , Rupa Jadhav & Bhagyashri Khopade.

The occasion was blessed with the presence of Prof. Dr. S. B. Patil (Principal, SCSCOE), Mr. R. S. Khamkar (Estate Manager, Rajgad Dnyanpeeth's) and all department HOD's, other Teaching, Non-teaching faculty of the college. The event was coordinated by Prof. K. S. Khamkar and Prof. K. R. Juare with support of members of Rangoli competition team.

**CONCLUSION:** The event not only provided a platform for the students to foster their creativity and decision making skills but also helped them explore their hidden talents and discover new areas of interest.



**Rangoli Competition – 2k23**



**Student preparing their Rangoli for competition**



**Guest for Rangoli Competition**



**Winner of Competition**

  
Prof. K. S. Khamkar, Prof. K. R. Juare  
**Cultural Coordinator**

  
Prof. Dr. S. B. Patil  
**Principal**



Principal  
Rajgad Dnyanpeeth's  
Sm. Chhatrapati Shivajiraje College of Engg.,  
Dhangawadi, Pune-412206





RajgadDnyanpeeth's  
**SHRI CHHATRAPATI SHIVAJIRAJE COLLEGE OF ENGINEERING**  
S. No. 237, Satara-Pune, NH-4, Dhangawadi, Tal: Bhor, Dist: Pune

Date: 15/02/2023

**Evaluation Sheet for Rangoli Competition on the  
Occasion of ANANT MOHOTSAV 2023**

Sr. No.	Group Number	Name of Participant	Criteria			Total Marks (30)	Rank
			Creativity (10M)	Clarity (10M)	Colour Combination (10M)		
	①	1. Samikha Pisal 2. Samikha Deshmukh	10	9	9	28	2 <sup>nd</sup>
	②	1. Snehal Pisal 2. Praja Bhandalkar. 3. Sayali Pawar.	10	8	9	27	3 <sup>rd</sup>
	③	1. Rutuja Kale 2. Gauri More	8	9	9	26	
	④	1. Gayatri Ganeshkar. 2. Rashmi Shinde.	10	9	9	28	2 <sup>nd</sup>
	⑤	1. Anja Barchi.	8	8	8	24	
	⑥	1. Asmita Bandal	8	8	8	24	
	⑦	1. Shreya Bhalke.	8	8	9	25	
	⑧	1. Vaibhav Lakhare 2. Vauphav Kadam 3. Omkar Karande.	8	7	7	22	

Sr. No.	Group Number	Name of Participant	Criteria			Total Marks (30)	Rank
			Creativity (10M)	Clarity (10M)	Colour Combination (10M)		
	9	1. Rutuja Maragaje.	8	8	8	24	
	10	1. Vaishnavi Vedpathak. 2. Rupa Tadhar. 3. Bhagyashri Khopade	9	9	9	27	3 <sup>rd</sup>
	11	1. Sakshi Salunke 2. Sejal Dhamal 3. Sneha Tampure	8	8	8	24	
	12	1. Vaishnavi Kadam 2. Jasad Deyani 3. Omkar Pednekar.	9	8	9	26	
	13	1. Abhinav Walhekar 2. Vaishnavi Patil 3. Akash Pandit	8	7	8	23	
	14	1. Aniket Suryawanshi 2. Valbhav Keshirsagar.	7	7	7	21	
	15	1. Somnath Waghmare 2. Ajay Suryawanshi 3. Samrath Khaire	9	8	8	25	
	16	1. Shivare Harbada 2. Raut Pooja 3. Dhadye Pragati	10	10	10	30	1 <sup>st</sup>

*Rohini / Rohan Zende*  
Event Co-ordinator

R.S. Nipanikar/  
G.K. Bhosale/  
R.R. Zende.



*(Signature)*  
Principal

Principal  
Rajgad Dnyanpeeth Technical Campus  
Shri Chhatrapati Shivajiraje College of Engineering  
Dhanyawadi, Dist. Pune - 412 205







**Rajgad Dnyanpeeth's**  
**SHRI CHHATRAPATI SHIVAJIRAJE COLLEGE OF ENGINEERING**  
 S. No. 237, Satara-Pune, NH-4, Dhangawadi, Tal: Bhor, Dist: Pune -412205 (MS), India.

### Result of Rangoli Competition Event 2k23

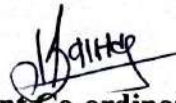
Sr. No.	Name of Student	Branch	Rank
1	1) Shivtare Harshada 2) Raut Pooja 3) Dhadve Pragati	B.E.Computer	I
2	1) Sanika Pisal 2) Sanika Deshmukh	1) T.E.Mechanical 2) T.E.Computer	II
3	1) Gayatri Ganeshkar 2) Rashmi Shinde	T.E.Computer	II
4	1) Snehal Pisal 2) Pooja Bhandalkar 3) Sayali Pawar	B.E.Civil	III
5	1) Vaishnavi Vedpathak 2) Rupa Jadhav 3) Bhagyashri Khopade	T.E.Computer	III

  
**Event Co-ordinator**

  
**Principal**



**Principal**  
 Rajgad Dnyanpeeth's  
 Shri Chhatrapati Shivajiraje College of Engg.,  
 Dhangawadi, Pune-412206



**Rajgad Dnyanpeeth's**  
**SHRI CHHATRAPATI SHIVAJIRAJE COLLEGE OF ENGINEERING**  
 S. No. 237, Satara-Pune, NH-4, Dhangwadi, Tal: Bhor, Dist: Pune -412205 (MS), India.

**Date: 02/02/2023**

## Mudra - 2023

It is hereby informed to all the students of Rajgad Dnyanpeeth's Technical Campus, Dhangwadi, Pune who passes any of the talents relating to cultural activities like; singing, dancing, music, poetry and acting ect. to register their names with the undersigned by or before 10<sup>th</sup> Feb 2023 for **audition to be conducted on 11<sup>th</sup> Feb 2023** and participation in upcoming cultural day i.e. "Mudra" celebration to be held on 17<sup>th</sup> Feb 2023.

Prof. K. S. Khamkar, Prof. K. R. Juare

**Cultural Coordinator**

Mr. R. S. Khamkar

**Estate Manager**  
**Estate Manager**

Rajgad Dnyanpeeth's Technical Campus  
 Dhangawadi, Pune-412205.



Prof. Dr. S. B. Patil

**Principal**  
**Principal**

Rajgad Dnyanpeeth's  
 Shri Chhatrapati Shivajiraje College of Engg.,  
 Dhangawadi, Pune-412206





Rajgad Dnyanpeeth's  
**SHRI CHHATRAPATI SHIVAJIRAJE COLLEGE OF ENGINEERING**  
Gat No. 237, Pune Bangalore Highway, Dhangawadi, Tal – Bhor, Dist- Pune (Maharashtra)

## REPORT ON MUDRA– 2k23

**DEPARTMENT:** All

**TITLE/TOPIC:** Mudra – 2k23

**DAY & DATE:** Friday, 17/02/2023

**DURATION OF EVENT:** 06.00 pm to 11.00 pm.

**STUDENT/STAFF PRESENT:** 1500/150

**CO-ORDINATOR:** Prof. K. S. Khamkar

Prof. K. R. Juare

**OBJECTIVE:** The culture is to be a dynamic, challenging and independent force based on freedom of expression that everyone is to be able to participate in cultural life, and that creativity, diversity and artistic quality are to be integral parts of society's development.

### DESCRIPTION:

Students Inter House cultural events “Mudra”, Solo, Duet and Group Dance Competition, Solo and Group Singing Competition, Drama Competition and Mimicry was organized at Rajgad Dnyanpeeth Technical Campus for all students of Diploma, Degree and Jr. College on 17th Feb. 2023. The competition began with great zest and excitement. The participants dressed in colorful costumes, twirled around and set the stage on fire with their thrilling performance.

Events were judged on choreography, stage coverage, costumes, thought, expressions and formation by esteemed judges Prof. P. M. Marne, Prof. D. A. More, Prof. S. S. Nalage and Prof. S. D. Pasalkar. Judges were overawed by the efforts of the participants and results were announced.

**The results of the competition are as follows:**

<b>Solo Dance Competition</b>	<b>Duet Dance Competition</b>
1. Nikhil Vanarse (FE Comp)	1. Natrang Group (TE Mech and TE Comp)
2. Shreya Bhelke (BE Comp)	2. SG Group (BE Comp)
3. Kajal Pawar (SE E&TC)	3. ECom Group (TE Comp and TE E&TC)



### Group Dance Competition

1. Hostel Boys (FE Comp and E&TC)
2. Freedom Group (TE) and Rising Star (FE)
3. SGS Group (BE Comp) and Yarana (BE Comp and BE Mech)

The occasion was blessed with the presence of Prof. Dr. S. B. Patil (Principal, SCSCOE), Mr. R. S. Khamkar (Estate Manager, Rajgad Dnyanpeeth's) and all department HOD's, other Teaching, Non-teaching faculty of the college. The event was coordinated by Prof. K. S. Khamkar and Prof. K. R. Juare with support of cultural coordinators and all other Teaching, Non-teaching faculty of the college.

**CONCLUSION:** The event not only provided a platform for the students to foster their extra-curricular skills but also helped them explore their hidden talents and discover new areas of interest.



It is our great pleasure to invite you for Annual Social Function

Friday on 17<sup>th</sup> Feb. 2023 by 6.00 P.M.

#### Annual Social Gathering

- Chief Guest -

Mr. Jadhav Saheb  
(Asst. Director, DTE)

Mrs. Vrushali Desai  
(P.S.I. Shirwal, Police Station)

Mr. Satish Andelwar  
(P.S.I. Shirwal, Police Station)

Mr. Nitin Khamgal  
(A.P.I. Kikoli, Police Station)

Mr. Nikhil Magdoom  
(A.P.I. Khedshivapur, Police Station)

Mr. Nandakumar Kokre  
(Principal, Krantijyoti Savitribai Phule,  
High School, Nargaw)

Regards From

Principal, Estate Manager, HOD, Teaching & Non - Teaching Staff,  
Rajgad Technical Campus, Dhargawadi, Tal. Bhor, Dist. Pune.



Invitation for Mudra – 2k23

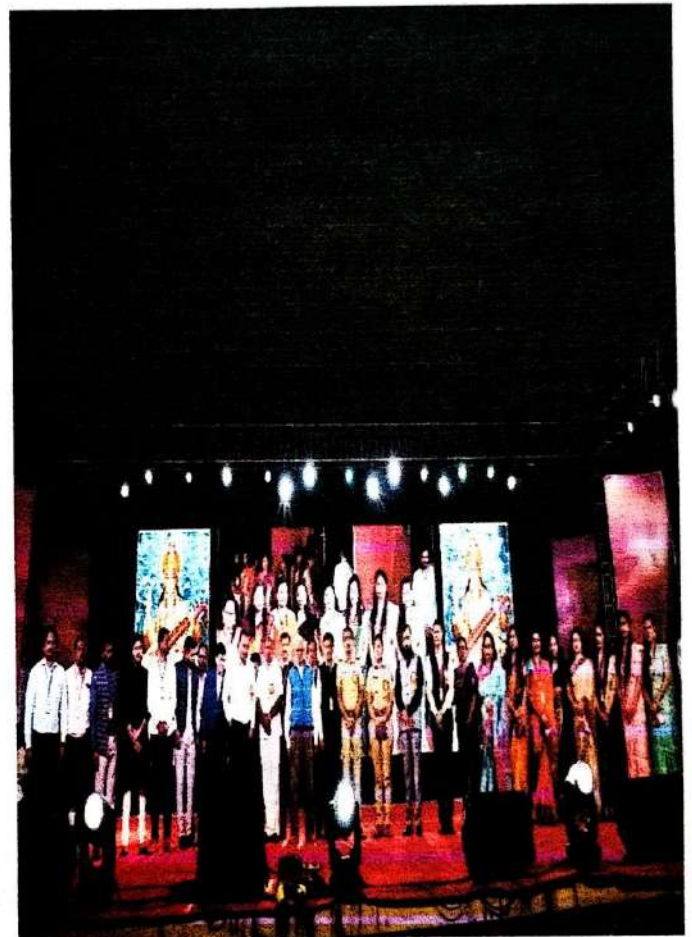

Guest for Mudra – 2k23







Student participation and performance for Mudra – 2k23



Student participation and performance for Mudra – 2k23



Stage and Campus for Mudra – 2k23



Judges for Mudra – 2k23

  
 Prof. K. S. Khamkar, Prof. K. R. Juare  
 Cultural Coordinator



  
 Prof. Dr. S. B. Patil  
 Principal

**Principal**  
 Rajgad Dnyanpeeth's  
 Shiv Chakra College of Engineering  
 Changawadi, Bhor, Pune-412306



Rajgad Dnyanpeeth's  
**SHRI CHHATRAPATI SHIVAJIRAJE COLLEGE OF ENGINEERING**  
Gat No. 237, Pune Bangalore Highway, Dhangawadi, Tal – Bhor, Dist- Pune (Maharashtra)

**REPORT ON RAJGAD KARANDAK – 2K23****DEPARTMENT:** All**TITLE/TOPIC:** Rajgad Karandak - 2023**DAY & DATE:** Saturday, 18/02/2023**DURATION OF EVENT:** 06.00 pm to 11.00 pm.**STUDENT/STAFF PRESENT:** 1500/150**CO-ORDINATOR:** Prof. K. S. Khamkar

Prof. K. R. Juare

**OBJECTIVE:** The culture is to be a dynamic, challenging and independent force based on freedom of expression that everyone is to be able to participate in cultural life, and that creativity, diversity and artistic quality are to be integral parts of society's development.

**DESCRIPTION:**

State level Group Dance competition was organized Rajgad Dnyanpeeth's SCSCOE, Dhangwadi for all colleges from Maharashtra on 18th Feb 2023. The theme of the competition was Folk Dance. The competition began with great zest and excitement. The participants dressed in colorful costumes, twirled around and set the stage on fire with their thrilling performance.

Events were judged on choreography, stage coverage, costumes, thought, expressions and formation by esteemed judges. Judges were overawed by the efforts of the participants and results were announced.

**The results of the competition are as follows:**

Name of Groups	Rank
1. Quixotic Group	First Rank
2. Shri Dance Academy, Wai	Second Rank
3. Nadyogi Kathak Academy	Third Rank

The event inauguration with hands of Hon'ble Sau. Swarupatai Thopte (Hon. Secretary, Rajgad Dnyanpeeth's, Bhor). The occasion was blessed with the presence of Mr. Nitin Bhargude Patil (Ex Vice President, Satara Z.P.), Mr. Rajendra Kachare (S. D. O. Bhor), Mr. Sachin Patil (Talsildar, Bhor), Mr. Sachin Patil (P. I. Nasarapur Police Station, Bhor), Mr. Navnath Madne





(P. I. Shirwal Police Station, Khandala), and Prof. Dr. S. B. Patil (Principal, SCSCOE), Mr. R. S. Khamkar (Estate Manager, Rajgad Dnyanpeeth's) and all department HOD's, other Teaching, Non-teaching faculty of the college. The event was coordinated by Prof. S. D. Pasalkar, Prof. K. S. Khamkar and Prof. K. R. Juare with support of cultural coordinators and all other teaching, non-teaching faculty of the college.

**CONCLUSION:** The event not only provided a platform for the students to foster their extra-curricular skills but also helped them explore their hidden talents and discover new areas of interest.



**Inaugration of Rajgad Karandak – 2k23**



**Inaugration of Rajgad Karandak – 2k23**



**Performance of Participants**

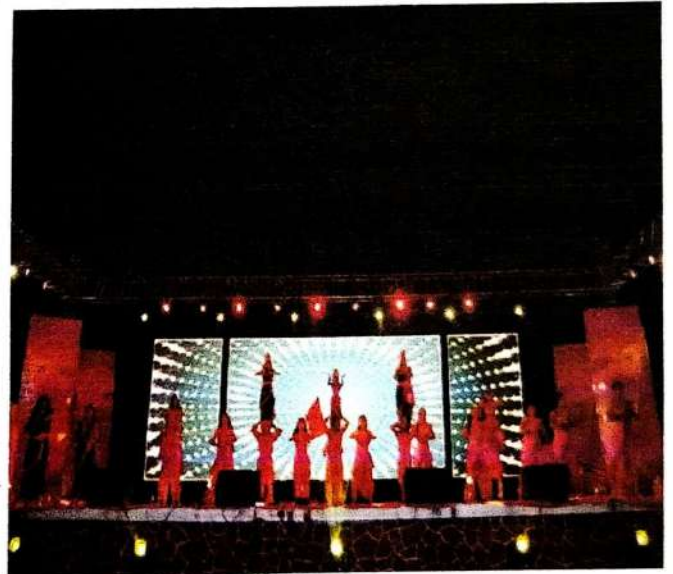

**Performance of Participants**







Audience for Rajgad Karandak – 2k23



Performance of Participants



Performance of Participants



Winners of Rajgad Karandak – 2k23

  
 Prof. K. S. Khamkar, Prof. K. R. Juare  
 Cultural Coordinator



  
 Prof. Dr. S. B. Patil  
 Principal  
**Principal**  
 Rajgad Dnyanpeeth's  
 Chhatravadi Shivajiraje College of Engg  
 Chhatravadi, Bhor, Pune-412206





Rajgad Dnyanpeeth's

**SHRI CHHATRAPATI SHIVAJIRAJE COLLEGE OF ENGINEERING**

Gat No. 237, Pune Bangalore Highway, Dhangawadi, Tal – Bhor, Dist- Pune (Maharashtra)

**REPORT ON SHIVJAYANTI – 2023****DEPARTMENT:** All**TITLE/TOPIC:** Shivjayanti - 2023**DAY & DATE:** Sunday, 19/02/2023**DURATION OF EVENT:** 08.00 am to 03.00 pm.**STUDENT/STAFF PRESENT:** 1500/150**CO-ORDINATOR:** Prof. K. S. Khamkar

Prof. K. R. Juare

**OBJECTIVE:** On the occasion of Shivjayanti, various activities are conducted in college in order to create awareness in the young minds of the students regarding valiant Maratha warrior and Shivaji Maharaj.

**DESCRIPTION:**

On the occasion of Shivjayanti, “Shivjayanti Utsav” was organized at Rajgad Dnyanpeeth Technical Campus for all students of Diploma, Degree and Jr. College on 19th Feb 2023. The event starts with bringing the Divine light (Jyot) from Purandar Fort then group of students performed Lezim along with Dhol Pathak and then Saraswati Pujan is done at college campus entrance by ladies staff. Prof. D. K. Khopade, Principal (SCSP) performed Sambhaji Maharaj statue pujan in college with Shambhu-garjana. After that Prof. Dr. S. B. Patil Principal of SCSCOE performed Shivaji Maharaj statue pujan in college with traditional Shiv-garjana. Some Ladies staff & student's sing palana geet of Shivaji Maharaj Birth anniversary.

The occasion was blessed with the presence of Prof. Dr. S. B. Patil (Principal, SCSCOE), Mr. R. S. Khamkar (Estate Manager, Rajgad Dnyanpeeth's) and all department HOD's, other Teaching, Non-teaching faculty of the college. The event was coordinated by Prof. K. S. Khamkar and Prof. K. R. Juare with support of cultural coordinators and all other Teaching, Non-teaching faculty of the college.

**CONCLUSION:** The event not only provided a platform for the students to foster their extra-curricular skills but also helped them explore their hidden talents and discover new areas of interest.







**At Purandhar Fort**



**Rally in College Campus**

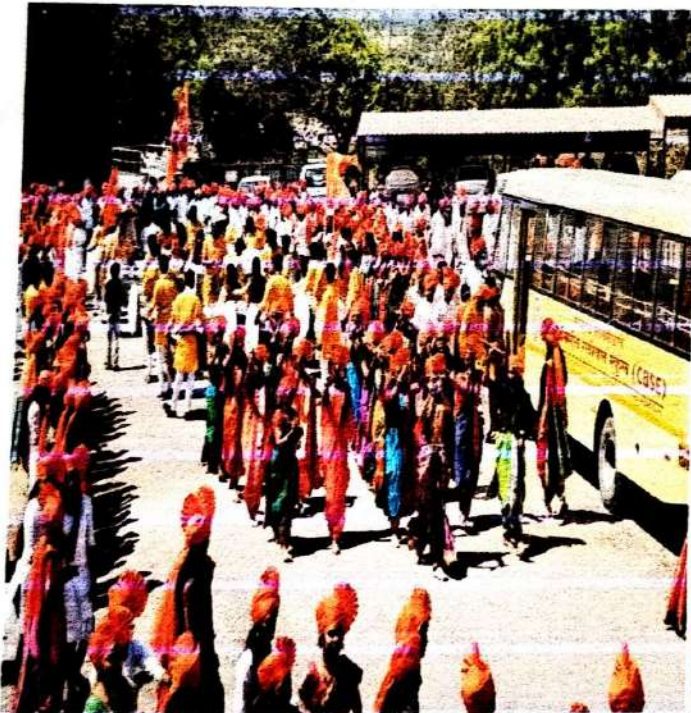

**Lezim Performance by students**



**Dhol -Tasha Pathak**







**Palana Geet of Shivaji Maharaj Birth Anniversary**



**Guest for Shivjayanti**



**Guest Speech on Chhatrapati Shivaji Maharaj**

*Khamkar*

Prof. K. S. Khamkar, Prof. K. R. Juare  
Cultural Coordinator



*Patil*

Prof. Dr. S. B. Patil  
Principal

**Principal**

Rajgad Dnyanpeeth's  
Chhatrapati Shivaji College of Engg.  
Dhargawadi, Bhor, Pune-412206





RajgadDnyanpeeth's  
**SHRI CHHATRAPATI SHIVAJIRAJE COLLEGE OF ENGINEERING**  
S. No. 237, Satara-Pune, NH-4, Dhangawadi, Tal: Bhor, Dist: Pune

DEPARTMENT OF LIBRARY

Date: 27<sup>th</sup> Feb 2023.

## NOTICE

Greetings to all.....!!

All the students and staff are hereby informed that our Rajgad Dnyanpeeth's Shri Chhatrapati Shivajiraje College of Engineering is celebrating "Marathi Bhasha Divas" On 27<sup>th</sup> Feb 2023 on the birth anniversary of Poet Kusumagraj respectively.

Various Book Exhibition are organized for the program. However we request you all please participate in the program.

**Date:** 28/02/2023

**Time :** 11.00am to 05.00pm

**Venue:** Central Library

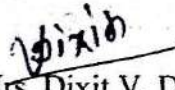
  
Mrs. Dixit V. D.  
Asst. Librarian

  
Mr. Kondagurla H. R.  
**LIBRARIAN**  
Shri Chhatrapati Shivajiraje  
College Of Engineering  
Dhangwadi, Tal. Bhor,  
Dist. Pune - 412206

  
Prof. Dr. Patil S. B.  
Principal  
Principal  
Rajgad Dnyanpeeth's  
Shri Chhatrapati Shivajiraje College of Engg.,  
Dhangawadi, Pune-412 205







Rajgad Dnyanpeeth's  
**SHRI CHHATRAPATI SHIVAJIRAJE COLLEGE OF  
ENGINEERING**

S. No. 237, Satara-Pune, NH-4, Dhangawadi, Tal: Bhor, Dist: Pune

**Report on  
"Vishnu Vaman Shirwadkar  
Birth Anniversary"**

**(28th February 2023)**

Organized By

Department of Library

In association with

**RDTC Polytechnic  
College, Bhor**





Date: 01/03/2023

**DEPARTMENT OF LIBRARY****Report on "Vishnu Vaman Shirwadkar (Kusumagraj) Birth Anniversary"**

1. **Title** : "Marathi Bhasha Gourav Divas"
2. **Duration**: 28<sup>th</sup> February 2023
3. **Time**: 11.30am to 05.00 pm.
4. **Mode of Conduction** : Offline
5. **Name of Co-coordinator** : Mrs. V. D. Dixit
6. **Number of Participants**: 197
7. **Objectives**:

His day is celebrated to recognize and honour the greatness of Marathi literature. Marathi language contains some of the oldest literature of all modern Indo-Aryan languages, dating from about 900 AD. The government started celebrating 'Marathi Rajbhasha Gaurav Din' after Kusumagraj's demise in 1999.

8. **Description**: In response to the notice given by Prof. Dr. S. B. Patil sir suggested conducting the Book Exhibition and Reading Habit on the life of kusumagraj in order to celebrate the birth anniversary. With this proposal, Mrs. V. D. Dixit has prepared. With the help of Librarian Mr. H. R. Kondagurla. The e-certificate was distributed to all participants.
9. **Conclusion**: Due to this event, students get aware of Vishnu Vaman Shirwadkar (Kusumagraj) life information. Vishnu Vaman Shirwadkar, popularly known by his pen name, Kusumagraj, was an eminent Marathi poet, playwright, novelist and short-story writer, apart from being a humanist, who wrote of freedom, justice, and emancipation of the deprived.





10. PHOTO:

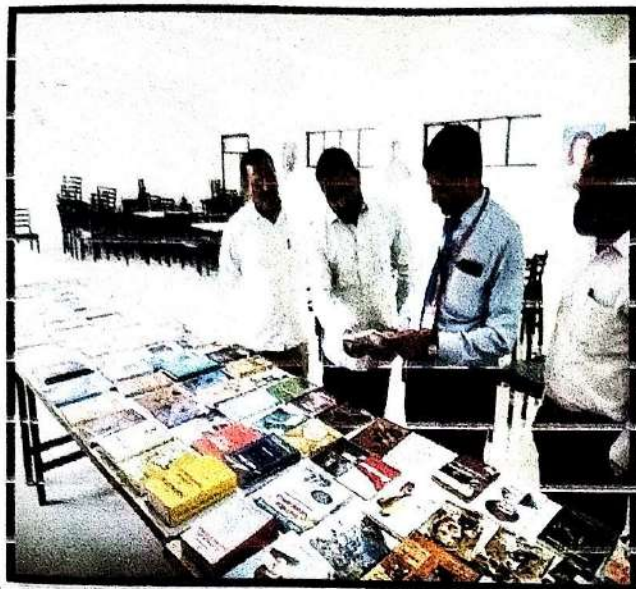

Photo: Book Browsing by Staff



Photo: Book Browsing by Students



Photo. Students is Readings Books & Novels

*(Signature)*

**Mrs.V.D.Dixit**  
Event Coordinator  
(Asst.Librarian)

*(Signature)*

**Mr.H.R.Kondagurla**  
**LIBRARIAN**  
Shri Chhatrapati Shivajiraje  
College Of Engineering  
Dhangwadi, Tal. Bhor,  
Dist. Pune - 412205

*(Signature)*

**Dr.S.B.Patil**  
Principal  
Rajgad  
Shri Chhatrapati Shivajiraje College of Engg.,  
Dhangawadi, Pune-412206







Department of Library

Day: Tuesday

Date: 28/02/2023

Time: 11.30am-05.00pm

Title of Program: Event on, " Vishnu Vaman Shirwadkar (Kusumagraj) Birth Anniversary Celebration"

Attendance Sheet

Sr. No.	Full Name	Department	Mobile No.	Sign
1	Gaikwad Shrishti	Computer	9322323844	Gaikwad
2	Bhasale Vaishnavi	Computer	9322525458	vaishnavi
3	Khairat Maheshwari	E & TC	8329691517	Maheshwari
4	Parvathana Sawant	11 <sup>th</sup>	9112432659	P.V.Sawant
5	Shrawani Dhamal	11 <sup>th</sup>	9545118110	S.M.Dhamal
6	Vaishnavi Veer	E & TC	7028615693	Veer
7	Shrawani Phadtare	E & TC	9922170730	Shrawani
8	Hingole Kishor	Mech	8660739139	Kishor
9	Pawar Shubham	FE Comp	9922732664	Shubham
10	Patil Siddhesh	FE comp	8398928722	Siddhesh
11	RENUSE RAT	FE COMP.	7057829294	Rat
12	Patil Atul	FE. AT&DS	9860457692	Patil
13	Shinde Sanika	FE AT&DS	9511708374	Shinde
14	Shinde Shraddha	FE	9309385114	S.M.Shinde
15	Yadav Prajakta	FE	9909402459	Yadav
16	Waghmare Pooja	F.E ESTC	7709501238	Pooja
17	Kanse Sakshi	F.E comp.	7020350005	Sakshi
18	Phadtar Nikita	-11-	9359634404	Nikita
19	Kulal Shruti	FE AIDS	8080282330	Shruti
20	Khairna Chetana	FE AT&DS	9730422660	Chetana
21	Shinde Triveni	FE comp.	8605417642	Shinde
22	Kamble Maya	FE Comp	7888178856	Maya
23	Shivtare Aakansha	SE civil	8010427404	Aakansha
24	Khankal Pratiksha	SE civil	8928017254	Pratiksha
25	Jadhav Yuvraj	SE. Mech	7798991903	Yuvraj
26	Sonawane prunav	SE. E & TC	9970626974	Prunav
27	Sonawane omkar.	SE E & TC	9022921082	Sonawane
28	Pawar Shubham	SE Mech	9321739379	Shubham
29	Mendhane Mayer	SE E & TC	7420978318	M.D.Mandhane

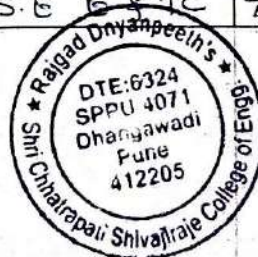



30	Jadhav shreyash	S.E E&TC	8857923728	<del>Shrestha</del>
31	Salekar Avishkar	S.E E&TC	8010440576	<del>AS</del>
32	Dhamal Prachi	S.E E&TC	8600672489	<del>Sharmal.</del>
33	Jadhav shravani	SE. E&TC	9096377472	<del>Shri</del>
34	Wadkar shruti	SE. E&TC	9373544395	<del>Wadkar.</del>
35	Bandal Ayo	SE E&TC	9579490508	<del>AS</del>
36	Badake Yogita	SE E&TC	8010374055	<del>Pradake.</del>
37	Chandanshiv shraddha	SE E&TC	9819928534	<del>Chandanshiv</del>
38	Bagal Mayuri	SE Comp.	7823897375	<del>Bagal</del>
39	Bhosale Vaishnavi	SE Comp	9021297317	<del>Shorals.</del>
40	Shinde Pournima	SE Comp	8956012061	<del>Shinde</del>
41	sonawane Parijata	SE Comp	992235742	<del>Paraw</del>
42	Ubale Anagha Yogesh	SE Comp	7058581661	<del>Ubbale</del>
43	Kharat Sonali Baban	SE Comp	7249194626	<del>Shat.</del>
44	Katkar shivani sudam	SE Comp	8010647625	<del>Katkar</del>
45	Garad vaishnavi Dada	SE Comp	9597607002	<del>Garad</del>
46	Bandal Asmita Rajendra	SE Comp	9699199240	<del>Bandal</del>
47	Jambe Vaishnavi Arjun	SE Comp	7038790042	<del>Jambe</del>
48	Bhaeudkar Diya Anil	SE Comp.	9503506446	<del>Bhaudkar</del>
49	More payal sanjay	SE Comp	9730778022	<del>More</del>
50	Tawade Chandrakant Karam	SE Comp	7517408901	<del>Tawade</del>
51	Nidhan BriJesh mishra	SE Comp	7499345228	<del>Nidha</del>
52	Tomange Harshda	SE Comp	8888103251	<del>Tomange</del>
53	May mayur Parthe	SE Comp	8080345020	<del>Mayur</del>
54	Sarode Namrata	SE Comp	8421432557	<del>Sarode</del>
55	Shelke Sakshi	SE Comp	9309292294	<del>Shelke</del>
56	Garad shrutika G.	SE Comp	8856816923	<del>S.H. Garad</del>
57	Nimbalkar Shivani R.	SE Comp	8766414915	<del>Nimbalkar</del>
58	Petkar Pooja Sunesh	SE Comp	9373700970	<del>Petkar</del>
59	Jagtap sanika santosh	SE Comp	8459350498	<del>Jagtap</del>
60	Bhokare Sakshi Deepak	F.E. A&P	9699366014	<del>Sakshi</del>
61	Divekar pooja Suryakant	FE Comp	8329749395	<del>Divekar</del>
62	Dhumal Amruta. T.	FE E&TC	7028128275	<del>Amruta</del>
63	Deshmukh Suchita S.	FE Comp.	9049416418	<del>Suchita.</del>
64	Parade Vaishnavi	FE Mech	9372365711	<del>Parade</del>
65	Jadhav Pratiksha	F.E. Mech.	9226011781	<del>Pradnav</del>
66	kamble maya.	FE Comp	788178856	<del>Kamble</del>

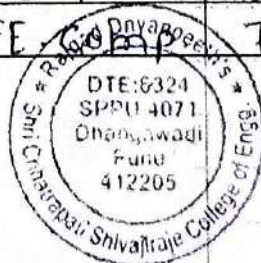



67	Triveni shinde	FE. Comp	8505417549	Goshinde
68	Bhosale Pooja	FE. E&TC	9552232812	Uppurjale
69	Padavai Ravina	FE. AIDS	8939213623	Kadimane
70	Khokle Rushikesh	FE. AIDS	9699235491	Rushikesh
71	Hemraj	F.E. Civil	7494985469	Hemraj
72	Naval shubham	F.E. Mecha	8329571413	Naval
73	Mule Ashish	F.E. Comp	8767870374	Mule
74	Warangule Pratiksha	FE. Comp.	9322825641	Warangule
75	Ulhalkar Bhagyshri	FE. Comp.	9699219752	Ulhalkar
76	Gayatri Gadade	FE. Com	7799810709	Gayatri
77	Aditya Saluj	FE. Comp	8782732251	Aditya
78	Raj Renuse	FE. Comp	7057829294	Raj
79	Patil Biddhesh	FE. Comp	8388328732	Patil
80	Pawar shubham	FE+Comp	9999739664	Pawar
81	Path Gujarathi	FE. Com	8179911390	Path
82	Shrawani Ulhalkar	TY Civil	7057606169	Shrawani
83	Bandre Anli	TY. Civil	8767152360	Bandre
84	Snehal Guttedar	TY civil	7840305693	Snehal
85	Wadkar shruti	SE E&TC	9373944389	Wadkar
86	Hirgude sanika	12th sci	9527526422	Hirgude
87	Pooja Parki	12th sci	7985937598	Parki
88	<del>Gayatri shirgude</del>	12th sci		
89	Sakshi zanje	12th sci	9890887371	Zanje
90	Tanushrizanie	12th sci	7499351778	Tanushri
91	Shiragavakar Gayatri	12th sci	9509879312	Gayatri
92	Kulal shruti	FE AIDS	8080282330	Kulal
93	Phadtar Nikita	FE. CS	9359634404	Phadtar
94	Raut Siddhi	FE. Mech	8698670560	Raut
95	Ashwini Wadhvale	11th science	8527003080	Ashwini
96	Sanika Kadam	11th Science	9768090934	Kadam
97	Poothana Sawant	11th science	9112432659	P.V. Sawant
98	Shrawani Dhamal	11th science	9545118110	S.M. Dhamal
99	Kimaya HOLE	11th science	9763468412	Kimaya
100	Sonawane Jagruti K.	FE mech	7219011495	Sonawane
101	Dhale srushti U.	FE AIDS	7843053394	Dhale
102	Shinde dnyaneshwari	FE AIDS	8176785110	Shinde
103	Gosaddha Shinde	FE Mech	110068666	Gosaddha

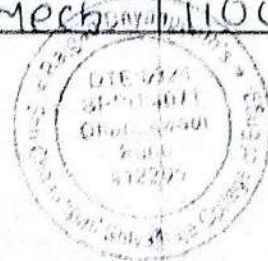



104	chondanshiv Priyanika	Computer	8668548735	Bhandarkar
105	Dube maheshwari	Mechanical	9764891401	Dube
106	Dhamal Prachi	E & TC	8767983037	Dhamal
107	Jadhav Shravani	E & TC	9625743212	Jadhav
108	Farande Aditi	Mechanical	2864726981	Farande
109	Gaikwad Shrutika	mechanical	9087960037	Gaikwad
110	surve Atul	Mechanical	8690382964	Surve
111	RsalunkheRuturaj	Mechanical	7448954081	Rsalunkhe
112	Jadhav Aditi	Mechanical	9267854621	Aditi
113	Chavan Anisha	E & TC	9876543211	Chavan
114	Jadhav Shreyash	E & TC	9876432198	Jadhav
115	choudhary Prathmesh	Computer	992464516	Choudhary
116	Avishkar Kubal	12 Science	8010231996	Kubal
117	Harshad Bathe	12 Science	9011639405	Harshad
118	Uday Shinde	12 <sup>th</sup> science	8806960158	UShinde
119	Dhamal Sahil	12 <sup>th</sup> Sci	9021911549	Dhamal
120	Vaibhav Sapkal	12 <sup>th</sup> Sci	9766737677	Sapkal
121	sanskar mansure	12 <sup>th</sup> sci	9823079402	Sanskar
122	Harshad Walhekar	12 <sup>th</sup> sci	9028458652	Walhekar
123	Mayur Petkar	12 <sup>th</sup> sci	8237127050	MPetkar
124	Prathmesh Shelar	12 <sup>th</sup> sci	9699876245	Prathmesh
125	Aryan Bobade	12 <sup>th</sup> sci	9929885473	Aryan
126	Dhiraj Bobade	12 <sup>th</sup> sci	9552492913	Bobade
127	chavan kiran	12 <sup>th</sup> sci	9588448747	Chavan
128	Ganesh Raut	12 <sup>th</sup> sci	7276777965	Ganesh
129	Soham Bhosale	12 <sup>th</sup> sci	9561476447	Soham
130	Akhya sondkar	12 <sup>th</sup> Sci	7378336003	A.Sondkar
131	Karan Bhosale	12 <sup>th</sup> sci	9623349723	Karan
132	Sujal shinde	12 <sup>th</sup> sci	8999628551	Sujal
133	Sahil Khutwad	12 <sup>th</sup> sci	7276358459	Sahil
134	yash Ahire	12 <sup>th</sup> sci	9359077562	yash
135	Aditya shivataze	12 <sup>th</sup> sci	9511609972	A.Sshivataze
136	Aditya chavan	12 <sup>th</sup> sci	7448134733	Aditya
137	yash chourhari	12 <sup>th</sup> sci	9156182205	Yash
138	Kaushal Nikilkar	12 <sup>th</sup> sci	8263007598	Nikilkar
139	Dikshant Punekar	12 <sup>th</sup> Sci	9082277628	Dpunekar
140	Shrikant Mge	12 <sup>th</sup> Sci	7298822415	S.Mge

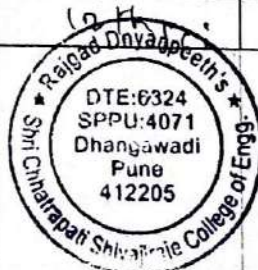



141	Samruce shankh	12 <sup>th</sup> scien	9022842337	S. Shankh,
142	Dnyaneshwari chavan	12 <sup>th</sup> scien	96723996937	D.A. chavan
143	Rajnandini Jagtap	12 <sup>th</sup> scien	8208866823	R.C. Jagtap
144	Bhagyeesha hemmole	12 <sup>th</sup> sci	713648271	Bhagyeesha
145	Sanghi Suke	12 <sup>th</sup> sci	9158841889	S.S. SUKE
146	Shravani More	12 <sup>th</sup> sci	9822864552	More
147	Vaishnavi Nigade	12 <sup>th</sup> Sci	8180025679	Nigade
148	Kanchan Ahire	12 <sup>th</sup> sci	7467060034	K.B. Ahire
149	Kausar Faras	12 <sup>th</sup> sci	9423930935	Kausar
150	Snehal Samruce	12 <sup>th</sup> sci	8329757665	<del>Snehal</del>
151	Vaishnavi Veer	12 <sup>th</sup> sci	9561211503	<del>Veer</del>
152	Taruni Thorat	12 <sup>th</sup> sci	7052333707	<del>Thorat</del>
153	Asmita Tanpure	12 <sup>th</sup> sci	8767356154	<del>Tanpure</del>
154	Shrutika Tanpure	12 <sup>th</sup> sci	9156732101	<del>Tanpure</del>
155	Neha Tanpure	12 <sup>th</sup> sci	9021393377	<del>Tanpure</del>
156	Dnyaneshwari Samgiz	12 <sup>th</sup> sci	7276330861	<del>Samgiz</del>
157	Praniti Choudhary	12 <sup>th</sup> sci	7972108714	<del>Praniti</del>
158	Aditi Bathe	12 <sup>th</sup> sci	8010604735	<del>Bathe</del>
159	Manasi Tanpure	12 <sup>th</sup> sci	8468850975	<del>Tanpure</del>
160	Nigade Sejal	12 <sup>th</sup> sci	7219433108	<del>Nigade</del>
161	Srushti Kamble	12 <sup>th</sup> sci	8459249163	<del>Kamble</del>
162	Diksha Chavan	12 <sup>th</sup> sci	8668344517	<del>Chavan</del>
163	Mahak Patel	12 <sup>th</sup> sci	8421195625	<del>Patel</del>
164	Muskan Kulari	12 <sup>th</sup> sci	7385875989	<del>Kulari</del>
165	Pradnya Sadhav	12 <sup>th</sup> Sci	7219728829	<del>P. Sadhav</del>
166	Samiksha Patil	12 <sup>th</sup> sci	7776025624	<del>S. Patil</del>
167	Shrutika Kote	12 <sup>th</sup> sci	8446409948	<del>Kote</del>
168	Krushnali Gaitwad	12 <sup>th</sup> sci	7822979708	<del>Gaitwad</del>
169	Vaishnavi Khopade	12 <sup>th</sup> sci	7276231575	<del>Khopade</del>
170	Sejal Nigade	12 <sup>th</sup> sci	7219433108	<del>Nigade</del>
171	Rajesh Waghmode	FE-AIDS	7888087079	<del>Rajesh</del>
172	Renuse Raj Rohul	FE. COMP.	7057829294	<del>Renuse</del>
173	Siddhant Paikekar	FE. COMP	9923235993	<del>Siddhant</del>
174	Sonika Mane	F.E. EGT	9699197627	<del>Sonika</del>
175	Khomane Vaishnavi	F.E. AIDS	9011567455	<del>V.P. Khomane</del>
176	More Pranjal	F.E. AIDS	7447547237	<del>More</del>
177	Kumbhar Shravan	F.E. EGT	9209477653	<del>Shravan</del>





178	Shinde Sanika Sanika	FE AIDS	9511708374	Shinde
179	Shinde Shraddha M.	FE	9309385114	S.M.Shinde
180	Zagade Nilakshi N.	FE EFTC	9970758452	Zagade
181	Pawar Pragati D.	FE CS	8999307106	Pawar
182	Pawar Sakshi S.	FE Mech	8600159559	Pawar
183	Shinde Hayhad S.	FE EFTC	9359550609	Shinde
184	Kolankar Rahul M.	FE AIDS	7058041915	Kolankar
185	Chandur Shiv Shradha	SE EFTC	9819928534	Chandur Shiv
186	Gorad Sanika G.	SE Mech	9834376851	Gorad
187	Kamble Rajratna N.	FE Comp	9623226629	Kamble
188	Khairmode Atharv P.	FE ENTC	9067796212	A.Khairmode
189	Kharmale Akshada S.	FE AIDS	9112618551	Kharmale
190	Gawade Gauri Sandip	FE AT & DS.	9307047931	Gawade
191	Gandhale Nilam Sampat	FE AT & DS	7823822012	Gandhale
192	Gaikwad Shrishti Sunil	FE Comp	9322323844	Gaikwad
193	Shinde Kirti Rajendra	SE Mech.	7972255970	Shinde
194	Shivtare Aakansha Arvind	SE Civil	8010427404	Shivtare
195	Shinde Pournima Pandurang	SE Comp	8956012061	Shinde
196	Pradip Pramod Sawane	FE AT & DS	9823716962	Pradip
197	Gayatri Cealade	Computer	7798810709	Gayatri
198	Prathmesh Dhamal	SE Civil	1231567890	Prathmesh
199				
200				
201				
202				
203				
204				
205				
206				
207				
208				
209				
210				
211				
212				
213				
214				





215			
216			
217			
218			
219			
220			
221			
222			
223			
224			
225			
226			
227			
228			
229			
230			

*V. D. Dixit*  
**Mrs. V. D. Dixit**  
**Asst. Librarian**



*H. R. Kondagurla*  
**Prof. H. R. Kondagurla**  
**Librarian**



# 17•Quiz on Mahatma Jyotiba Phule Jayanti



Rajgad Dnyanpeeth's  
**SHRI CHHATRAPATI SHIVAJIRAJE COLLEGE OF ENGINEERING**  
S. No. 237, Satara-Pune, NH-4, Dhangawadi, Tal: Bhore, Dist: Pune

Date: 11<sup>th</sup> April 2023.

## NOTICE

All Students, Teaching & Non-Teaching staff of Rajgad Dnyanpeeth's Technical Campus, Shri Chhatrapati Shivajiraje College of Engineering, Dhangawadi are hereby informed that, **Department of Library** Organized Online Quiz competition & Worship of Krantisurya Mahatma Jyotiba Phule Birth Anniversary on 11<sup>th</sup> April, 2023 at 11:15 am.

Venue: - Central Library.

Mrs. V. D. Dixit  
Asst. Librarian

Prof. H. R. Kondagurta  
**LIBRARIAN**  
Shri Chhatrapati Shivajiraje  
College Of Engineering  
Dhangwadi, Tal. Bhore,  
Dist. Pune - 412206

Prof. Dr. S. B. Patil  
Principal

Principal  
Rajgad Dnyanpeeth's  
Shri Chhatrapati Shivajiraje College of Engg.,  
Dhangawadi, Pune-412 205





Rajgad Dnyanpeeth's  
**SHRI CHHATRAPATI SHIVAJIRAJE COLLEGE OF  
ENGINEERING**

S. No. 237, Satara-Pune, NH-4, Dhangawadi, Tal: Bhor, Dist: Pune

**Report on  
"Mahatma Jyotiba Phule Jayanti-  
Quiz Competition"**

**(11th April 2023)**

**Organized By**

**Department of Library**

**In association with**

**RDTC Polytechnic  
College, Bhor**







Rajgad Dnyanpeeth's  
**SHRI CHHATRAPATI SHIVAJIRAJE COLLEGE OF ENGINEERING**  
Gat No. 237, Pune Bangalore Highway, Dhangawadi, Tal – Bor, Dist- Pune (MH)

**DEPARTMENT OF LIBRARY**

**REPORT – “E-Quiz on “Mahatma Jyotiba Phule Jayanti- Quiz Competition ”for celebration of 196<sup>th</sup> Birth Anniversary.”**

1. **TITLE/TOPIC:** “E-Quiz on “Mahatma Jyotiba Phule Jayanti- Quiz Competition ”for celebration of 196<sup>th</sup> Birth Anniversary.”
2. **DAY & DATE:** Tuesday, 11th April 2023.
3. **DURATION OF SESSION:** 11.00 am to 5.00 pm
4. **MODE OF CONDUCTION:** Online
5. **PLAT FORM:** Google Form.
6. **LINK FOR E-QUIZ :** <https://forms.gle/eBTX9j2n1txAr2fu5>
7. **RESPONSE/ATTENDANCE:** 28
8. **COORDINATOR:** Mrs. Dixit, V.D. (Asst.Librarian)
9. **OBJECTIVE:** 1) To create Awareness on the need for education.
10. **DESCRIPTION:** Department of Library organized e-quiz on Mahatma Jyotiba Phule Birth Anniversary 11<sup>th</sup> April 2023 for E-Quiz competition on student and staff. Jyotirao Govindrao Phule was an Indian writer, social activist, thinker and anti-caste social reformer from Maharashtra. He is known to work towards the eradication of untouchability and the caste system and for his efforts in educating women. He and his wife, Savitribai Phule, were pioneers of women's education in India. He was born on April 11, 1827, and his birth anniversary is celebrated as Jyotiba Phule Jayanti every year.
11. **CONCLUSION:** All aspirants inspired and satisfied.



12. PHOTOS:-



Photo 1. Mahatma Jyotiba Phule Pratima Poojan by Prof. Dr. S. B. Patil (Principal)



Photo 2. Mahatma Jyotiba Phule Pratima Poojan by Mr. R.S. Khamkar (Estate Manager)





Photo 3. Mahatma Jyotiba Phule Pratima Poojan by Mr. G.S. Jagtap (Office Superintendent)



Photo 4. Staff & Student Group photo

  
**Mrs. V.D. Dixit**  
Event Coordinator  
(Asst. Librarian)

  
**Mr. H.R. Kondagurle**  
Shri Chhatrapati Shivajiraje  
College Of Englaecring  
Dhangawadi, Tal. Bhor,  
Dist. Solapur

  
**Dr. S.B. Patil**  
Principal  
Principal  
Rajgad Dnyanpeeth's  
Shri Chhatrapati Shivajiraje College of Engg.,  
Dhangawadi, Pune-412 205





# Mahatma Jyotiba Phule Jayanti- Quiz Competition-RDTC SCSCOE

Mahatma Jyotiba Phule Jayanti- Quiz Competition Organized by Department of Library, RD's Shri Chhatrapati Shivajiraje College of Engineering, Dhangawadi, Pune-412205 on 11th April 2023.

All Participants will get e-certificate on successful completion of Quiz.

\* Indicates required question

1. Email \*

---

2. Name of Participant \*

---

3. Name of the Institute \*

---

4. Mobile Number \*

---

5. Location/ City \*

---



## Mahatma Jyotiba Phule Jayanti

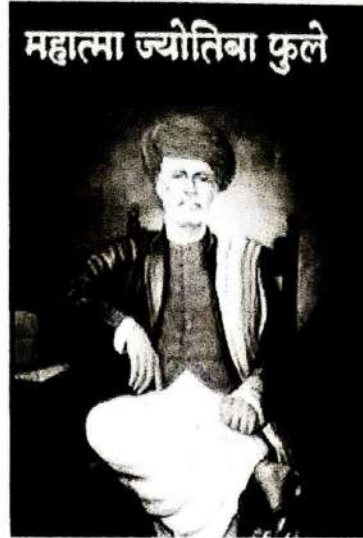

## Mahatma Jyotiba Phule Jayanti- Quiz Competition

6. 1) In which year Jyotirao Phule was born? \*

1 point

Mark only one oval.

- 1792
- 1827
- 1854
- 1890

7. 2) Which modern day state did Phule belong to? \*

1 point

Mark only one oval.

- Maharashtra
- Rajasthan
- Tamil Nadu
- Andhra Pradesh





8. 3) Who was his wife, who championed right to education for girls? \*

1 point

Mark only one oval.

- Savitabai  
 Ramabai  
 Savitribai  
 Rukminibai

9. 4) Which among the followings is the movement Phule founded? \*

1 point

Mark only one oval.

- Satyashodhak Samaj  
 Ramakrishna Mission  
 Arya Samaj  
 Brahmo Samaj

10. 5) What did Savitribai Phule learned from her husband? \*

1 point

Mark only one oval.

- Painting.  
 Singing.  
 To read and write.  
 Farming

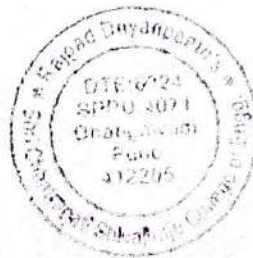

11. 6) Who wrote the book 'Jotirao Phule and the ideology of social revolution in India' \* 1 point

Mark only one oval.

- B R Ambedkar  
 Eleanor Zelliot  
 Gail Omvedt  
 Kancha Ilaiah

12. 7) Mahatma Jyotiba Phule Jayanti \* 1 point

Mark only one oval.

- 10th March 1897.  
 12th February 1899.  
 7th May 1890.  
 11th April 1827.

13. 8) Who started First Primary School for girls in India \* 1 point

Mark only one oval.

- Dr. B. R. Ambedkar  
 Rajshri Shahu Maharaj  
 Bal Shashtri Jambhekar  
 Mahtma Jyotiba Phule





14. 9 ) When did Jyotirao Phule die? \*

1 point

Mark only one oval.

- 1896
- 1910
- 1827
- 1890

15. 10) when the first girls school started \*

1 point

Mark only one oval.

- January 1, 1848
- January 1, 1849
- January 1, 1847
- January 1, 1948



This content is neither created nor endorsed by Google.

Google Forms



Rajgad Dnyanpeeth's  
SHRI CHHATRAPATI SHIVAJIRAJE COLLEGE OF ENGINEERING  
S. No. 237, Satara-Pune, NH-4, Dhangawadi, Tal: Bhore, Dist: Pune

Department of Library

Day: Tuesday

Date: 11/04/2023

Time: 11.00am-05.00pm

Title of Program: Event on, " Mahatma Jyotiba Phule Jayanti- Quiz Competition "for celebration of 196th Birth Anniversary"

Attendance Sheet

Sr.No.	Name of Participant	Email Address	Mobile Number	Location/ City
1	Shital Prakash Salunkhe	shitalpsalunkhe@gmail.com	9860171442	Bhor
2	Gaikwad Sakshi Bhimaji	sakshigaikwad12347@gmail.com	8767960689	Bhor
3	Miss.Thorave Sonali Ma	sonalithorave5073@gmail.com	9822571542	Wai
4	Shreyash Jadhav	shreyashjadhav0304@gmail.com	8857923728	Wai
5	T M Dudhane	tmdudhane@yahoo.com	9922341662	Bhor
6	Chemate Jija Bapusaheb	nilukale709@gmail.com	9011826102	Bhor
7	Sanika santhosh Jagtap	sanikaja2002@gmail.com	8459250498	Saswad
8	Shruti Vijay Wadkar	shrutiwadkar1818@gmail.com	9373544395	Pune
9	Varad bhagawat Hillal	varadhillal@gmail.com	8767833008	Pune
10	Yogita Mahesh Bodake	yogitabodake6@gmail.com	+918010374055	Pune Bhor
11	Ganesh Dambe	gmrdevil107@gmail.com	9096094983	Pune
12	Anisha Rahul Chavan	anishachavan854@gmail.com	9309009459	Pune
13	Omkar Vijay jagtap	omkarjagtap8094@gmail.com	8010984144	Pune
14	Rohan kanade	rohankanade28@gmail.com	9970976113	Naigaon
15	Pawan Sachin Budhawan	budhawantpawan25@gmail.com	9850284871	Dhangawadi, Pune
16	Tanvi Shamrao Ravalekar	tanviravlekar1894@gmail.com	9527742536	Dhangawadi
17	Danavale Vaishnavi Sant	vaishnavidanavale@gmail.com	9527233785	Pune
18	Ramdas yadu kondhalkar	kondhalkarom2004@gmail.com	9604928769	Bhor
19	Swamini Maruti Bhor	bhorswamini@gmail.com	7498933544	Valati
20	Sujata Bathe	sujata.bathe@gmail.com	9049512021	Pune
21	Siddiqui Ayesha Abutali	siddiquiayasha8312@gmail.com	7058668738	Dhangawadi, Bhor, Pune
22	Kale rushikesh vishwas	kalerushikeah832@gmail.com	7972717370	Stara
23	Harshvardhan Mahajan	harshvardhan.mahajan27@gmail.com	9284625193	AURANGABAD
24	Gire Shruti Sanjay	shrutigire8@gmail.com	9322938138	Dhangawadi
25	Chavan Sakshi Santosh	chavansakshi362@gmail.com	8767593268	Dhangawadi
26	Raut Trupti Sunil	rauttrupti765@gmail.com	9373696032	Dhangawadi
27	Govind Fartade	mathsrdtc123@gmail.com	9383747474	Dhangawadi
28	Manasi Hanumant Bharg	mansibhargude0802@gmail.com	9552900247	Dhangawadi







Rajgad Dnyanpeeth's

## Shri Chhatrapati Shivajiraje College of Engineering

(Approved by AICTE, Recognized by Government of Maharashtra &  
Affiliated to Savitribai Phule Pune University, Pune)  
Dhangawadi, Tal: Bhor, Dist: Pune, Maharashtra, India  
Website: www.rajgad.edu.in Email: scscoe@gmail.com



Department of Library

### Mahatma Jyotiba Phule Jayanti-Quiz Competition

### CERTIFICATE OF PARTICIPATION

This is to certify that,

{{full name}}

has successfully completed **Mahatma Jyotiba Phule Jayanti-Quiz Competition** Organized by Department of Library, RD's Shri Chhatrapati Shivajiraje College of Engineering, Dhangawadi, Pune-412205 on 11 April 2023.

Mrs. V. D. Dixit  
Co-ordinator

Mr. H. R. Kondagurla  
Librarian



Dr. S. B. Patil  
Principal

# 18•Quiz on Dr. Babasaheb Ambedkar Jayanti

Dear all☺☺

Greetings from Rajgad Dnyanpeeth's Shri Chhatrapati Shivajiraje College of Engineering Dhangwadi , Pune!!!

\*Department of Library is organizing E-quiz on \*Dr. Babasaheb Ambedkar Jayanti.\*

\*Link\*: <https://forms.gle/JWwKaTBs4UQVxqnZA>

\*The Google form is open from 14th April 2023.\*

- ◆ Open to all
- ◆ Please click on the link to participate
- ◆ \*No registration fee\*
- ◆ The link will be open until 14<sup>th</sup> To 17<sup>th</sup> April 2023
- ◆ Please, do participate and kindly forward the above mentioned e-quiz information to your Friends.

For more information

\* coordinator\*

Mrs. V. D. Dixit

\*Librarian\*

Mr. H. R. Kondagurla

\*Principal\*

Prof. Dr. Patil S. B.

SCSCOE







Rajgad Dnyanpeeth's  
**SHRI CHHATRAPATI SHIVAJIRAJE COLLEGE OF  
ENGINEERING**

S. No. 237, Satara-Pune, NH-4, Dhangawadi, Tal: Bhor, Dist: Pune

**Report on  
"Dr. Babasaheb Ambedkar  
Birth Anniversary"**

**(14th to 17th April 2023)**

**Organized By**

**Department of Library**

**In association with**

**RDTC Polytechnic  
College, Bhor**





Date: 17/04/2023

DEPARTMENT OF LIBRARY

Report on "Dr. Babasaheb Ambedkar Birth Anniversary"

1. **Title of Quiz :** Dr. Babasaheb Ambedkar Birth Anniversary
2. **Duration:** 14<sup>th</sup> To 17<sup>th</sup> April 2023.
3. **Mode of Conduction :** Online
4. **Link for E-Quiz :** <https://forms.gle/JWwKaTBs4UQVxqnZA>
5. **Name of Co-coordinator :** Mrs. V. D. Dixit
6. **Number of Participants:** 34
7. **Introduction:** The engineering college celebrated Dr. Babasaheb Ambedkar Jayanti with great enthusiasm by organizing a quiz competition on the life, contributions, and philosophy of Dr. B.R. Ambedkar. The event aimed to enlighten and educate students about the ideals and principles advocated by Dr. Ambedkar, fostering a spirit of equality, justice, and empowerment among the participants.
8. **Objectives:**
  - To disseminate knowledge about the life and works of Bharat Ratna Dr. B. R. Ambedkar among the target group.
  - To sensitize them to fight against social evils prevailing in the society, especially caste restrictions.
9. **Description:** In response to the notice given by NDLI by Prof. Dr. S. B. Patil sir suggested conducting the e-quiz on the life of Dr. Babasaheb Ambedkar in order to celebrate the birth anniversary. With this proposal, Mrs. V. D. Dixit has prepared the e contest. With the help of Librarian Mr. H. R. Kondagurla. The e-certificate was distributed to all participants.





**10. Conclusion:** Due to this event, students get aware of Dr. B. R. Ambedkar's life information. He was a great reformer, jurist, economist, orator, and anthropologist. He is commonly known as the "Father of the Constitution" of India. His ideologies and thoughts were the base of the Indian Constitution. His extraordinary personality was carrying a story of the struggles he has gone through in his childhood and young days.



**Mrs. V.D. Dixit**  
Event Coordinator  
(Asst. Librarian)



**Mr. H.R. Kondagurla**  
**LIBRARIAN**  
Shri Chhatrapati Shivajiraje  
College Of Engineering  
Dhangwadi, Tal. Bhor,  
Dist. Pune - 412206



**Dr. S.B. Patil**  
Principal

Principal  
Rajgad Dnyanpeeth's  
Shri Chhatrapati Shivajiraje College of Engg.,  
Dhangawadi, Pune-412 205





Rajgad Dnyanpeeth's  
**Shri Chhatrapati Shivajiraje College of Engineering**

(Approved by AICTE, Recognized by Government of Maharashtra &  
Affiliated to Savitribai Phule Pune University, Pune)  
Dhangawadi, Tal: Bhor, Dist: Pune, Maharashtra, India  
Website: www.rajgad.edu.in Email: scscoe@gmail.com



**Department of Library**

**Dr. Babasaheb Ambedkar Jayanti -Quiz Competition**

**CERTIFICATE OF PARTICIPATION**

This is to certify that,

{{full name}}

has successfully completed **Dr. Babasaheb Ambedkar Jayanti-Quiz Competition** Organized by Department of Library, RD's Shri Chhatrapati Shivajiraje College of Engineering, Dhangawadi, Pune-412205 on 14th April 2023.

  
Mrs. V. D. Dixit  
Co-ordinator

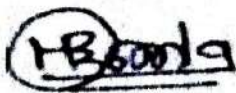
  
Mr. H. R. Kondagurla  
Librarian



  
Dr. S. B. Patil  
Principal





Rajgad Dnyanpeeth's  
**SHRI CHHATRAPATI SHIVAJIRAJE COLLEGE OF ENGINEERING**  
S. No. 237, Satara-Pune, NH-4, Dhangawadi, Tal: Bhor, Dist: Pune

**Department of Library**

Day: Friday

Date: 14 to 17/04/2023

Time: 11.00am-05.00pm

Title of Program: Event on " Dr. Babasaheb Ambedkar Birth Anniversary".

**Attendance Sheet**

Sr.No.	Name of Participate	Email id	Mob. No.	Address
1	Bhor Swamini Maruti	bhorswamini@gmail.com	7498933544	Pune
2	Shital Prakash Salunkhe	shitalpsalunkhe@gmail.com	9860171442	Bhor
3	Vaishnavi Santosh Danavale	vaishnavidanavale@gmail.com	9527233785	Pune
4	Miss.Thorave Sonali Mahadev	sonalithorave5073@gmail.com	9822571542	Wai
5	Upparbawde Sneha	snehaupparbawade@gmail.com	7972795527	Pune
6	Prajakta ulhas medhekar	prajaktamedhekar2001@gmail.com	7030720228	Pune
7	Shital Prakash Salunkhe	shitalpsalunkhe@gmail.com	9860171442	Bhor
8	Gaikwad Sakshi Bhimaji	sakshigaikwad12347@gmail.com	8767960689	Bhor
9	Miss.Thorave Sonali Mahadev	sonalithorave5073@gmail.com	9822571542	Wai
10	Shreyash Jadhav	shreyashjadhav0304@gmail.com	8857923728	Wai
11	T M Dudhane	tmdudhane@yahoo.com	9922341662	Bhor
12	Chimate Jija Bapusaheb	nilukale709@gmail.com	9011826102	Bhor
13	Sanika santhosh Jagtap	sanikaja2002@gmail.com	8459250498	Saswad
14	Shruti Vijay Wadkar	shrutiwadkar1818@gmail.com	9373544395	Pune
15	Varad bhagawat Hillal	varadhillal@gmail.com	8767833008	Pune
16	Yogita Mahesh Bodake	yogitabodake6@gmail.com	+918010374055	Pune Bhor
17	Ganesh Dambe	gmrdevil107@gmail.com	9096094983	Pune
18	Anisha Rahul Chavan	anishachavan854@gmail.com	9309009459	Pune
19	Omkar Vijay jagtap	omkarjagtap8094@gmail.com	8010984144	Pune
20	Rohan kanade	rohankanade28@gmail.com	9970976113	Naigaon
21	Pawan Sachin Budhawant	budhawantpawan25@gmail.com	9850284871	Dhangawadi, P
22	Tanvi Shamrao Ravalekar	tanviravlekar1894@gmail.com	9527742536	Dhangawadi
23	Danavale Vaishnavi Santosh	vaishnavidanavale@gmail.com	9527233785	Pune
24	Ramdas yadu kondhalkar	kondhalkarom2004@gmail.com	9604928769	Bhor
25	Swamini Maruti Bhor	bhorswamini@gmail.com	7498933544	Valati
26	Sujata Bathe	sujata.bathe@gmail.com	9049512021	Pune
27	Siddiqui Ayesha Abutalib	siddiquiayasha8312@gmail.com	7058668738	Dhangwadi, Bho
28	Kale rushikesh vishwas	kalerushikeah832@gmail.com	7972717370	Stara
29	Harshvardhan Mahajan	harshvardhan.mahajan27@gmail.com	9284625193	AURANGABA
30	Chav Shrut Sanjay	shrutigire8@gmail.com	9322938138	Dhangawadi
31	Chavan Sakshi Santosh	chavansakshi362@gmail.com	8767593268	Dhangawadi
32	Raut Trupti Sunil	rauttrupti765@gmail.com	9373696032	Dhangawadi
33	Govind Parade	mathsrdtc123@gmail.com	93837474747	Dhangawadi
34	Manshi Hanumant Bhargude	mansibhargude0802@gmail.com	9552900247	Dhangawadi



# Dr. Babasaheb Ambedkar Jayanti- Quiz Competition-SCSCOE -2023

Dr. Babasaheb Ambedkar Jayanti- Quiz Competition Organized by Department of Library,  
RD's Shri Chhatrapati Shivajiraje College of Engineering, Dhangawadi, Pune-412205 on  
14th April 2023.

All Participants will get e-certificate on successful completion of Quiz.

\* Indicates required question

1. Email \*

---

2. Name of Participant \*

---

3. Name of the Institute \*

---

4. Department \*

---

5. Mobile Number \*

---

6. Location/ City \*

---





बोधिसत्व डॉ. बाबासाहेब आंबेडकर जयंती

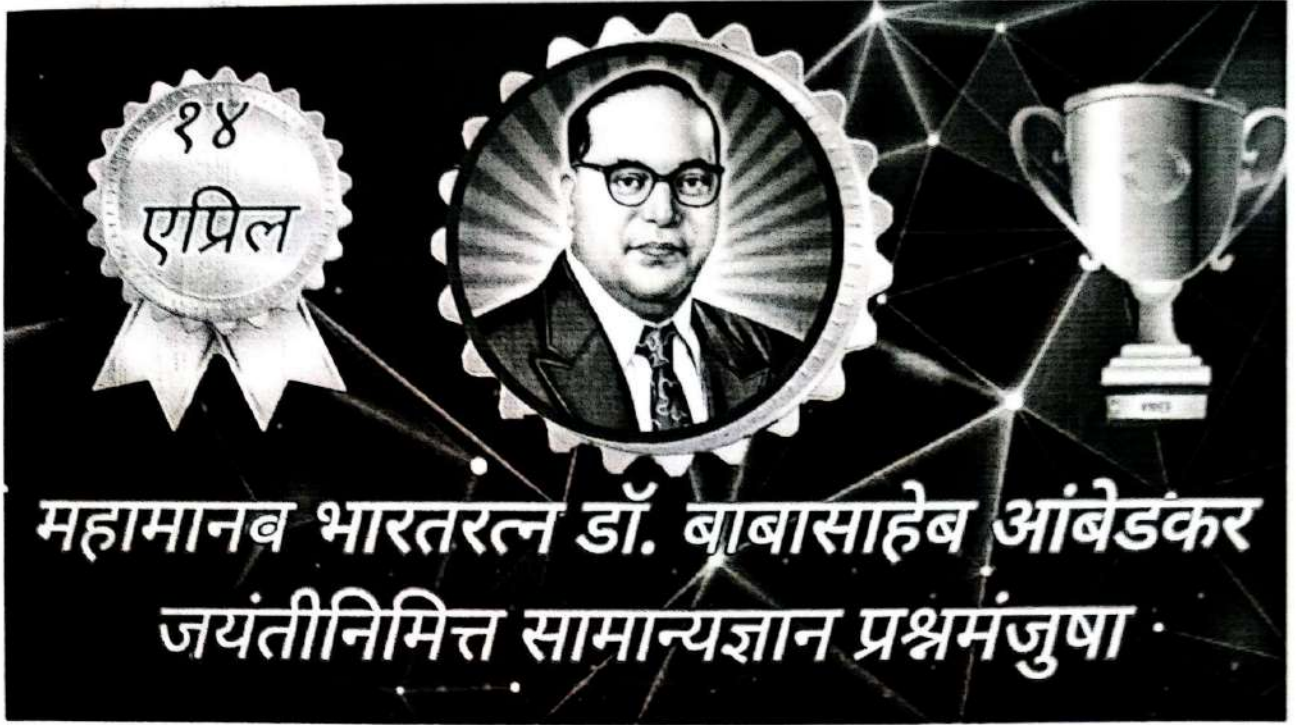

Dr. Babasaheb Ambedkar Jayanti- Quiz Competition

7. डॉ. बाबासाहेब आंबेडकर यांनी खालीलपैकी कोणत्या मंदिरासाठी सत्याग्रह केला होता? \* 2 points

Mark only one oval.

- गणपती मंदिरमहादेव
- काळाराम मंदिर
- महादेव मंदिर
- हनुमान मंदिर



8. डॉ. बाबासाहेब आंबेडकर यांच्यावर कोणाकोणाचा प्रभाव होता ? \*

Mark only one oval.

- महात्मा फुले  
 गौतम बुद्ध  
 वरील दोन्ही  
 वर्धमान महाविर

9. खालीलपैकी कोणाच्या अध्यक्षतेखाली सर्वात पहिली बुद्ध जयंती काढण्यात आली होती ?

\* 2 points

Mark only one oval.

- महात्मा फुले  
 बाबासाहेब आंबेडकर  
 शाहू महाराज  
 वरील नाही

10. डॉ. बाबासाहेब आंबेडकर यांनी हिंदू कोड बिल चा प्रस्ताव कोणत्या सभागृहात मांडला होता ?

\* 1 point

Mark only one oval.

- विधानसभा  
 लोकसभा  
 राज्यसभा  
 वरीलपैकी सर्व





11.

डॉ. बाबासाहेब आंबेडकर यांनी धम्मदिक्षा खालीलपैकी कोणत्या ठिकाणी घेतली आहे ?

\* 1 point

Mark only one oval.

- सोलापूर
- नागपूर
- नाशिक
- कोल्हापूर

12.

डॉ. बाबासाहेब आंबेडकर यांनी खालीलपैकी कोणते वृत्तपत्र सुरु केले होते ? \*

2 points

Mark only one oval.

- जनता
- मूकनायक
- समता
- वरील सर्व

13.

डॉ. बाबासाहेब आंबेडकर यांना एकूण किती भाषा ज्ञान होते ? \*

2 points

Mark only one oval.

- बारा
- अकरा
- दहा
- चौदा



60/1/2023

3:15 PM

14. डॉ. बाबासाहेब आंबेडकर यांच्या नावाने महाराष्ट्रामध्ये कुठे विमानतळ आहे ? \*

2 points

Mark only one oval.

- नाशिक
- नागपूर
- पुणे
- अमरावती

15. मूकनायक हे पाक्षिक डॉ. बाबासाहेब आंबेडकर यांनी कोणत्या ठिकाणी सुरु केले होते ?

\* 2 points

Mark only one oval.

- नाशिक
- नागपूर
- मुंबई
- दिल्ली

16. डॉ. आंबेडकरांना शिक्षणासाठी परदेशी जाण्यास कोणी मदत केली ? \*

2 points

Mark only one oval.

- छत्रपती शाहू महाराज
- प्रार्थना समाज
- राव बहादुर वडियार
- सयाजीराव गायकवाड





17. पुणे करार ..... यांच्यात घडून आला.

Mark only one oval.

- आगरकर - लोकमान्य टिळक
- लॉर्ड रिपन - ज्योतिराव फुले
- डॉ. आंबेडकर - महात्मा गांधी
- मोर्ले मिंटो - शाहू महाराज

18. आम्हाला कोणाची भीक नको, झगडून हक्क हवेत", हे विचार कोणत्या समाजसुधारकाचे आहेत ?

\* 2 points

Mark only one oval.

- विठ्ठल रामजी शिंदे
- डॉक्टर आंबेडकर
- महात्मा फुले
- कर्मवीर भाऊराव पाटील

19. डॉ. बाबासाहेब आंबेडकर यांनी काळाराम मंदिर सत्याग्रह कोणत्या वर्षी सुरु केला होता ?

\* 2 points

Mark only one oval.

- 2 मार्च 1933
- 2 मार्च 1932
- 2 मार्च 1930
- 2 मार्च 1931



3:15 PM

20.

डॉ. बाबासाहेब आंबेडकर यांची प्रतिमा कोणत्या आंतरराष्ट्रीय विद्यापीठात स्थापित केलेली आहे?

\* 2 points

Mark only one oval.

- कोलंबिया
- केंब्रिज
- मॅसाच्युसेट्स
- यापैकी नाही

21. डॉ. बाबासाहेब आंबेडकर यांच्याकडे स्वतंत्र भारतात कुठले मंत्रिपद होते

2 points

Mark only one oval.

- कामगार मंत्री
- कायदा आणि न्याय मंत्री
- अर्थ मंत्री
- प्रधान मंत्री

22. डॉ. बाबासाहेब आंबेडकरांच्या स्मारक स्थळाचे नाव काय आहे ?

2 points

Mark only one oval.

- समता स्थल
- चैत्य भूमी
- वीर भूमी
- बौद्ध भूमी



This content is neither created nor endorsed by Google.