

**Criteria 3: Research, Innovations and Extension****Key Indicator – 3.4 Collaboration**

**3.4.1 The Institution has several collaborations/linkages for Faculty exchange, Student exchange, Internship, Field trip, on-the- job training, research etc. during the year 2021-22.**

| Sr. No | Title of the collaborative activity | Name of the collaborating agency with contact details | Name of the collaborating agency with contact details                | Duration From | Duration To | Number of Participant | Duration |
|--------|-------------------------------------|---|--|---------------|-------------|-----------------------|----------|
| 01     | Field Trip                          | Industrial visit for subject understanding            | Dhom Hydro Power Station   | 19/05/2022    | 19/05/2022  | 40/02                 | 1 Day    |
| 02     | Field Trip                          | Industrial visit for subject understanding            | TE Connectivity  | 17/05/2022    | 17/05/2022  | 50/02                 | 1 Day    |
| 03     | Field Trip                          | Industrial visit for subject understanding            | Thermal fecal sludge treatment Plant, Wai Taluka - Wai, Dist- Satara | 13/05/2022    | 13/05/2022  | 55/03                 | 1 Day    |
| 04     | Field Trip                          | Industrial visit for subject understanding            | Material Recovery Facilities Centre, Wai Taluka -Wai, Dist-Satara    | 13/05/2022    | 13/05/2022  | 55/03                 | 1 Day    |
| 05     | Internship                          | Internship  | Oasis Infobyte   | 4/05/2022     | 4/06/2022   | 1                     | 1 Months |
| 06     | Internship                          | Internship  | Oasis Infobyte   | 2/05/2022     | 2/06/2022   | 7                     | 1 Months |
| 07     | Internship                          | Internship  | Oasis Infobyte   | 1/05/2022     | 30/05/2022  | 2                     | 1 Months |

|    |            |  |  |            |            |        |          |
|----|------------|--|--|------------|------------|--------|----------|
| 08 | Internship | Internship                                 | Pranav Enterprises   | 1/05/2022  | 1/06/2022  | 1      | 1 Months |
| 09 | Internship | Internship                                 | Forage   | 01/05/2022 | 01/06/2022 | 2      | 1 Months |
| 10 | Internship | Internship                                 | Lets Grow More   | 01/05/2022 | 01/06/2022 | 12     | 1 Months |
| 11 | Internship | Internship                                 | Oasis Infobyte   | 29/04/2022 | 29/05/2022 | 1      | 1 Months |
| 12 | Field Trip | Industrial visit for subject understanding | CEM Electromech  | 28/04/2022 | 28/04/2022 | 30/02  | 2 Days   |
| 13 | Internship | Internship                                 | Officika Technologies PVT.LTD.                               | 22/04/2022 | 22/05/2022 | 15     | 1 Months |
| 14 | Field Trip | Industrial visit for subject understanding | FE Visit   | 19/04/2022 | 19/04/2022 | 105/02 | 1 Day    |
| 15 | Internship | Internship                                 | Raj Polyfabrics Pvt. Ltd, Jejuri MIDC, Purandar, Pune.       | 15/04/2022 | 18/05/2022 | 2      | 1 Months |
| 16 | Field Trip | Industrial visit for subject understanding | Gunjawani Earthen Dam, Taluka Velhe, District Pune.          | 12/04/2022 | 12/04/2022 | 50/02  | 1 Day    |
| 17 | Field Trip | Industrial visit for subject understanding | Gunjawani Hydropower Plant, Gunjawani, Tal-Velvhe, Dist-Pune | 12/04/2022 | 12/04/2022 | 50/02  | 1 Day    |
| 18 | Internship | Internship                                 | Dynamic Solution Pvt. Ltd. Baner Pune                        | 08/04/2022 | 20/05/2022 | 1      | 1 Months |

|    |            |  |  |            |            |       |          |
|----|------------|--|--|------------|------------|-------|----------|
| 19 | Field Trip | Industrial visit for subject understanding | Pune Alternate Fuel Conclave(AFC)                          | 5/04/2022  | 5/04/2022  | 60/02 | 1 Day    |
| 20 | Internship | Internship                                 | Prabhupada World   | 05/04/2022 | 05/05/2022 | 2     | 1 Months |
| 21 | Field Trip | Industrial visit for subject understanding | Khambataki Tunnel, Khandala, Taluka Khandala, Dist- Satara | 4/04/2022  | 4/04/2022  | 45/02 | 1 Day    |
| 22 | Internship | Internship                                 | iGeeks Bridging Technology                                 | 03/04/2022 | 06/05/2022 | 1     | 1 Months |
| 23 | Internship | Internship                                 | Property Solution India Pvt. Ltd.                          | 02/04/2022 | 30/05/2022 | 1     | 1 Months |
| 24 | Internship | Internship                                 | Smart Knowner- Online internship                           | 02/04/2022 | 05/05/2022 | 1     | 1 Months |
| 25 | Internship | Internship                                 | E.CAD. Computer Institute                                  | 1/04/2022  | 30/04/2022 | 2     | 1 Months |
| 26 | Internship | Internship                                 | ILJIN Global India PVT. LTD.                               | 1/04/2022  | 30/04/2022 | 5     | 1 Months |
| 27 | Internship | Internship                                 | M.CAD Training Institute                                   | 1/04/2022  | 30/04/2022 | 1     | 1 Months |
| 28 | Internship | Internship                                 | Mayuresh Plastics  | 1/04/2022  | 30/04/2022 | 4     | 1 Months |

|    |            |            |  |            |            |   |            |
|----|------------|------------|--|------------|------------|---|------------|
| 29 | Internship | Internship | SGK India Industrial Services(P) LTD.                    | 1/04/2022  | 30/04/2022 | 1 | 1 Months   |
| 30 | Internship | Internship | Vighanharta Enterprises                                  | 1/04/2022  | 30/04/2022 | 1 | 1 Months   |
| 31 | Internship | Internship | Sunanda Infotech PVT.LTD.                                | 01/04/2022 | 01/05/2022 | 1 | 1 Months   |
| 32 | Internship | Internship | Lets Grow More-Virtual Internship                        | 01/04/2022 | 01/05/2022 | 3 | 1 Months   |
| 33 | Internship | Internship | CAD Desk- Virtual Internship                             | 01/04/2022 | 15/05/2022 | 1 | 1.5 Months |
| 34 | Internship | Internship | inled Technologies LLP. Mhavashi, Khandala, satara       | 01/04/2022 | 01/06/2022 | 1 | 1 Months   |
| 35 | Internship | Internship | Highlight Electricals and Service. Baramati Pune         | 01/04/2022 | 30/04/2022 | 1 | 1 Months   |
| 36 | Internship | Internship | Ideal Designs Engineering & PCB Designing. Shivane Pune. | 01/04/2022 | 08/05/2022 | 4 | 1 Months   |
| 37 | Internship | Internship | Arete Manufacturing Services Pvt. Ltd. Dhyari Pune.      | 01/04/2022 | 30/04/2022 | 1 | 1 Months   |

|    |            |            |   |            |            |    |          |
|----|------------|------------|---|------------|------------|----|----------|
| 38 | Internship | Internship | Wimson Electronics Pvt. Ltd. Shindewadi, Bhor, Pune | 01/04/2022 | 30/04/2022 | 1  | 1 Months |
| 39 | Internship | Internship | Supreme Facility Management Pvt. Ltd. Akurdi Pune   | 01/04/2022 | 30/04/2022 | 1  | 1 Months |
| 40 | Internship | Internship | Cummins Indi Limited. Phaltan.                      | 18/03/2022 | 14/04/2022 | 1  | 1 Months |
| 41 | Internship | Internship | Safe express Pvt. Ltd. , Shindewadi , Bhor, Pune    | 15/03/2022 | 15/05/2022 | 1  | 2 Months |
| 42 | Internship | Internship | Expro North Sea LTD                                 | 9/03/2022  | 27/04/2022 | 1  | 1 Months |
| 43 | Internship | Internship | College Ranker India                                | 09/03/2022 | 09/04/2022 | 01 | 1 Months |
| 44 | Internship | Internship | Geeks for Geeks - Online Internship                 | 05/03/2022 | 08/04/2022 | 1  | 1 Months |
| 45 | Internship | Internship | Shreyash IT Solution                                | 5/03/2022  | 1/05/2022  | 1  | 1 Months |
| 46 | Internship | Internship | EGEARZ PVT.LTD.                                     | 1/03/2022  | 31/03/2022 | 1  | 1 Months |

|    |                  |   |   |            |             |       |          |
|----|------------------|---|---|------------|-------------|-------|----------|
| 47 | Field Trip       | Industrial visit for subject understanding    | QualEx Systems Pvt. Ltd                             | 1/03/2022  | 1/03/2022   | 60/02 | 1 Day    |
| 48 | Internship       | Internship                                    | Abstract IT Solutions                               | 01/03/2022 | 01/05/2022  | 1     | 2 Months |
| 49 | Internship       | Internship                                    | Spectris Technology Pvt.Ltd, Bavdhan,Pune           | 01/03/2022 | 30/04/2022  | 3     | 2 Months |
| 50 | Internship       | Internship                                    | L&D Infotech Pvt. Ltd., Katraj Pune                 | 01/03/2022 | 01/05/2022  | 9     | 2 Months |
| 51 | Internship       | Internship                                    | In Yantra Technologies Pvt. Ltd., Shirwal, Khandala | 01/03/2022 | 30/04/2022  | 3     | 2 Months |
| 52 | Internship       | Internship                                    | Vardhan Consulting Engineering                      | 28/02/2022 | 22/03/2022  | 1     | 1 Months |
| 53 | Field Trip       | Industrial visit for subject understanding    | VCB Electronics                                     | 22/02/2022 | 22/02/2022  | 70/02 | 1 Day    |
| 54 | Internship       | Internship                                    | Oasis Infobyte                                      | 1/02/2022  | 1/03/2022   | 1     | 1 Months |
| 55 | Faculty Exchange | Expert Lecture on, "Digital Image Processing" | Karmyogi Engineering Engineering, Pandharpur        | 20/01/2022 | 20/01//2022 | 00/01 | 1        |

|    |            |            |   |            |            |    |          |
|----|------------|------------|---|------------|------------|----|----------|
| 56 | Internship | Internship | S.R.Construction  | 20/01/2022 | 20/03/2022 | 2  | 1 Months |
| 57 | Internship | Internship | STP Developers,<br>Shirwal                              | 15/01/2022 | 10/04/2022 | 02 | 1 Months |
| 58 | Internship | Internship | Shree Venkatesh<br>Buildcon                             | 15/01/2022 | 15/02/2022 | 2  | 1 Months |
| 59 | Internship | Internship | Omkar<br>Constructions,<br>Bhor                         | 15/01/2022 | 10/04/2022 | 2  | 1 Months |
| 60 | Internship | Internship | Omkar buidling &<br>material suppliers                  | 15/01/2022 | 10/04/2022 | 2  | 1 Months |
| 61 | Internship | Internship | Anurag<br>Constructions<br>Nigadi Pune                  | 15/01/2022 | 10/04/2022 | 1  | 1 Months |
| 62 | Internship | Internship | Kunjir Bioenergy<br>India LLP<br>Mirawadi Daund<br>Pune | 15/01/2022 | 10/04/2022 | 2  | 1 Months |
| 63 | Internship | Internship | Aakar Construction<br>Pvt. Ltd. Shirwal                 | 15/01/2022 | 10/04/2022 | 4  | 1 Months |
| 64 | Internship | Internship | Sneh Buildcon,<br>Loni                                  | 15/01/2022 | 25/02/2022 | 1  | 1 Months |

|    |            |            |  |            |            |   |          |
|----|------------|------------|--|------------|------------|---|----------|
| 65 | Internship | Internship | Sahyadri Construction, Sangali                     | 15/01/2022 | 10/04/2022 | 1 | 1 Months |
| 66 | Internship | Internship | SSA Steel Pvt. Ltd., Pune                          | 15/01/2022 | 10/04/2022 | 5 | 1 Months |
| 67 | Internship | Internship | Rajgad Sahakari Sakhar Karkhana, Nigde, Bhor, Pune | 15/01/2022 | 10/04/2022 | 5 | 1 Months |
| 68 | Internship | Internship | Sarvesh Construction Company, Satara               | 15/01/2022 | 10/04/2022 | 6 | 1 Months |
| 69 | Internship | Internship | Anant Dudh Pvt. Ltd., Kikavi, Pune                 | 15/01/2022 | 10/04/2022 | 6 | 1 Months |
| 70 | Internship | Internship | Shrinath Developers, At post-Gunand, Bhor ,Pune    | 15/01/2022 | 10/04/2022 | 7 | 1 Months |
| 71 | Internship | Internship | Mass infra Builders & Developers                   | 15/01/2022 | 10/04/2022 | 2 | 1 Months |
| 72 | Internship | Internship | Delval Flow Control PVT.LTD.                       | 10/01/2022 | 10/02/2022 | 1 | 1 Months |
| 73 | Internship | Internship | Trisons Engineering                                | 10/01/2022 | 10/02/2022 | 3 | 1 Months |



|    |            |            |   |            |            |   |            |
|----|------------|------------|---|------------|------------|---|------------|
| 74 | Internship | Internship | Sanjay Construction & Developers, Saswad                            | 08/01/2022 | 20/03/2022 | 2 | 1 Months   |
| 75 | Internship | Internship | Tikona Construction   | 06/01/2022 | 15/03/2022 | 2 | 1 Months   |
| 76 | Internship | Internship | Innotronix Labs & Trading Pvt. Ltd. Sasewadi, Bhor, Pune            | 03/01/2022 | 18/02/2022 | 5 | 1.5 Months |
| 77 | Internship | Internship | Egearz Private Ltd. Shindewadi, Khandala, Satara                    | 03/01/2022 | 18/02/2022 | 1 | 1.5 Months |
| 78 | Internship | Internship | Surya Engineering Works, Shirwal.                                   | 03/01/2022 | 18/02/2022 | 1 | 1.5 Months |
| 79 | Internship | Internship | Chheda Electricals & Electronics Pvt. Ltd. Palashi, Khandala Satara | 03/01/2022 | 18/02/2022 | 1 | 1.5 Months |
| 80 | Internship | Internship | United Crain & Components Pvt. Ltd. Pune                            | 03/01/2022 | 18/02/2022 | 1 | 1.5 Months |
| 81 | Internship | Internship | Ambika Plastics Latur   | 1/01/2022  | 31/1/2022  | 1 | 1 Months   |
| 82 | Internship | Internship | KSB Limited   | 1/01/2022  | 31/01/2022 | 1 | 1 Months   |

|    |            |   |   |            |            |        |               |
|----|------------|---|---|------------|------------|--------|---------------|
| 83 | Internship | Internship  | Er.Ramesh. B.<br>Jaiswal Contractor,<br>Aundh | 20/12/2021 | 05/02/2022 | 2      | 1.5<br>Months |
| 84 | Internship | Internship  | Saraswati<br>Construction, wai                | 20/12/2021 | 05/02/2022 | 02     | 1.5<br>Months |
| 85 | Internship | Internship  | K.P. Technologies                             | 20/12/2021 | 18/02/2022 | 2      | 1 Months      |
| 86 | Internship | Industrial visit<br>for<br>subject<br>understanding | Rajgad Sugar<br>Factory Nigade                | 17/12/2021 | 17/12/2021 | 92/03  | 1 Day         |
| 87 | Internship | Internship  | Durvesh<br>Engineering Works                  | 15/12/2021 | 20/01/2022 | 2      | 1 Months      |
| 88 | Internship | Internship  | Shree Samarth<br>Automation                   | 15/12/2021 | 15/01/2022 | 1      | 1 Months      |
| 89 | Internship | Internship  | Surya Engineering<br>Works                    | 13/12/2021 | 21/01/2022 | 1      | 1 Months      |
| 90 | Internship | Internship  | Tejas Motors                                  | 10/12/2021 | 20/01/2022 | 1      | 1 Months      |
| 91 | Internship | Industrial visit<br>for<br>subject<br>understanding | Metrological<br>Station Kenjal                | 7/12/2021  | 7/12/2021  | 25-Feb | 1 Day         |

|     |            |  |                                    |            |            |       |          |
|-----|------------|--|------------------------------------|------------|------------|-------|----------|
| 92  | Internship | Industrial visit for subject understanding | Waste water Treatment Plant Kenjal | 7/12/2021  | 7/12/2021  | 42/02 | 1 Day    |
| 93  | Internship | Internship                                 | ACG Capsules                       | 06/12/2021 | 15/01/2022 | 6     | 1 Months |
| 94  | Internship | Internship                                 | CADME Metal Crafts                 | 2/12/2021  | 21/01/2022 | 1     | 1 Months |
| 95  | Internship | Internship                                 | Aura Laserfab PVT.LTD.             | 1/12/2021  | 10/01/2022 | 1     | 1 Months |
| 96  | Internship | Internship                                 | Baliraja Enterprises               | 1/12/2021  | 31/12/2021 | 2     | 1 Months |
| 97  | Internship | Internship                                 | Bombay Generator LTD.              | 1/12/2021  | 30/12/2021 | 1     | 1 Months |
| 98  | Internship | Internship                                 | D.B.Lad Engineering Works          | 1/12/2021  | 30/12/2021 | 1     | 1 Months |
| 99  | Internship | Internship                                 | GE India Industrial PVT.LTD.       | 1/12/2021  | 30/12/2021 | 1     | 1 Months |
| 100 | Internship | Internship                                 | KLAUS Multipacking System Shirwal  | 1/12/2021  | 10/01/2022 | 2     | 1 Months |
| 101 | Internship | Internship                                 | Omkar Enterprises                  | 1/12/2021  | 31/12/2021 | 2     | 1 Months |

|     |                  |   |  |            |            |       |          |
|-----|------------------|---|--|------------|------------|-------|----------|
| 102 | Internship       | Internship  | SANHUA India PVT.LTD.  | 1/12/2021  | 31/12/2021 | 1     | 1 Months |
| 103 | Internship       | Internship  | Specialty Sintered Products PVT.LTD.   | 1/12/2021  | 30/12/2021 | 1     | 1 Months |
| 104 | Internship       | Internship  | ACG Worldwide  | 01/12/2021 | 31/12/2021 | 2     | 1 Months |
| 105 | Faculty Exchange | “Design of L & T-Shape Retaining wall”            | Karmyogi Engineering College, Pandharpur   | 18/11/2021 | 18/11/2021 | 00/01 | 1        |
| 106 | Faculty Exchange | Expert lecture on, “Data base and Management”     | Padmabhushan Vasantdada Patil Pratishthan's College of Engineering, Sion - Chunabhatti, Near Everard Nagar, Mumbai | 17/11/2021 | 17/11/2021 | 00/01 | 1        |
| 107 | Faculty Exchange | “Machine learning & Its Application”              | Karmyogi Engineering College , Pandharpur  | 17/11/2021 | 17/11/2021 | 00/01 | 1        |
| 108 | Faculty Exchange | Expert Lecture On “Water Treatment Plant”         | Samarth Group of Institute College of Engineering, Belhe , Pune  | 15/11/2021 | 15/11/2021 | 00/01 | 1        |
| 109 | Faculty Exchange | Expert lecture on, “Data structure and algorithm” | Padmabhushan Vasantdada Patil Pratishthan's College of Engineering, Sion - Chunabhatti, Near Everard Nagar, Mumbai | 09/11/2021 | 09/11/2021 | 00/01 | 1        |

|     |                   |  |  |            |            |       |          |
|-----|-------------------|--|--|------------|------------|-------|----------|
| 110 | Internship        | Internship   | Ambika Fabrication Works   | 1/11/2021  | 31/01/2022 | 1     | 1 Months |
| 111 | Internship        | Internship   | Athani Sugars LTD  | 1/11/2021  | 31/01/2022 | 1     | 1 Months |
| 112 | Faculty Exchange  | Machine learning ”   | Karmyogi Engineering College, Pandharpur   | 19/10/2021 | 19/10/2021 | 00/01 | 1        |
| 113 | Faculty Exchange  | “Thermal analysis of Steam Power Plant”                        | Karmyogi Engineering College, Pandharpur   | 13/10/2021 | 13/10/2021 | 00/01 | 1        |
| 114 | Internship        | Internship   | Riya Engineering’s   | 10/10/2021 | 20/11/2021 | 4     | 1 Months |
| 115 | Internship        | Internship   | Shankar Enterprises  | 3/10/2021  | 10/03/2022 | 3     | 1 Months |
| 116 | Faculty Exchange  | Expert lecture on, “Microstrip Antenna Design and Applications | Padmabhushan Vasantdada Patil Pratishthan's College of Engineering, Sion - Chunabhatti, Near Everard Nagar, Mumbai | 13/09/2021 | 13/09/2021 | 00/01 | 1        |
| 117 | Sponsored Project | Sponsored Project  | Gsoft Solution Pvt.Ltd Warje Pune  | 15/09/2021 | 15/04/2022 | 04    | 6 Months |

|     |                   |                   |  |            |            |    |          |
|-----|-------------------|-------------------|--|------------|------------|----|----------|
| 118 | Internship        | Internship        | Rieter India PVT.LTD.  | 6/09/2021  | 6/10/2021  | 1  | 1 Months |
| 119 | Sponsored Project | Sponsored Project | K-Star Plastic Industries Shirwal MIDC Khandala                                | 1/09/2021  | 1/03/2022  | 04 | 6 Months |
| 120 | Sponsored Project | Sponsored Project | Shri. Radhakrishan Cement pipes & Products, Kolki, Taluka-Phaltan, Dist-Satara | 25/08/2021 | 25/03/2022 | 04 | 7 Months |
| 121 | Internship        | Internship        | VCB Electronics Private Limited, Khed Shivapur Pune                            | 19/08/2021 | 19/09/2021 | 1  | 1 Months |
| 122 | Sponsored Project | Sponsored Project | S. A. Sheth Engineers & Government Contractors, Thane, Mumbai                  | 5/08/2021  | 5/05/2022  | 04 | 9 Months |
| 123 | Sponsored Project | Sponsored Project | Microversion Technologies Goldmine housing Society Wai                         | 2/08/2021  | 2/02/2022  | 04 | 6 Months |
| 124 | Sponsored Project | Sponsored Project | Mythos Technology Narhe Pune   | 1/08/2021  | 1/02/2022  | 04 | 6 Months |
| 125 | Sponsored Project | Sponsored Project | Mythos Technology Narhe Pune   | 1/08/2021  | 1/02/2022  | 04 | 6 Months |

|     |                   |                   |   |            |            |    |           |
|-----|-------------------|-------------------|---|------------|------------|----|-----------|
| 126 | Sponsored Project | Sponsored Project | Mythos Technology Narhe Pune                                      | 1/08/2021  | 1/02/2022  | 04 | 6 Months  |
| 127 | Sponsored Project | Sponsored Project | L& D Infotech Pvt. Ltd DSK Vishwa Pune                            | 01/08/2021 | 15/02/2022 | 03 | 6 Months  |
| 128 | Sponsored Project | Sponsored Project | Cow Health Monitoring System using IoT                            | 1/08/2021  | 1/05/2022  | 03 | 9 Months  |
| 129 | Sponsored Project | Sponsored Project | Face Mask & body Temperature Detection using Arduino Uno          | 1/08/2021  | 1/05/2022  | 03 | 9 Months  |
| 130 | Sponsored Project | Sponsored Project | Intelligent Exam Paper Leakage Detection                          | 1/08/2021  | 1/05/2022  | 03 | 9 Months  |
| 131 | Sponsored Project | Sponsored Project | IoT based EV's Battery Swapping & Charging system using Solar     | 1/08/2021  | 1/05/2022  | 03 | 9 Months  |
| 132 | Sponsored Project | Sponsored Project | DE Shree Dhananjay Electricals MIDC Kodoli Satara                 | 15/07/2021 | 15/05/2022 | 04 | 9 Months  |
| 133 | Sponsored Project | Sponsored Project | Pranav Construction, At post-Shirwal, taluk Khandala, Dist-Satara | 15/07/2021 | 15/04/2022 | 04 | 9 Months  |
| 134 | Sponsored Project | Sponsored Project | Anant Dudh Pvt. Ltd., Kikavi, Taluka-Bhor, Dist - Pune            | 01/07/2021 | 23/05/2022 | 04 | 10 Months |

|     |                  |                        |   |            |            |       |         |
|-----|------------------|------------------------|---|------------|------------|-------|---------|
| 135 | Faculty Exchange | Basic Power Electronic | Rajgad Dnyanpeeth,s Technical Campus Polytechnic Dhangawadi, Tal-Bhor, Dist- Pune | 23/03/2022 | 23/03/2022 | 00/01 | 1       |
| 136 | Faculty Exchange | Embedded System        | Rajgad Dnyanpeeth,s Technical Campus Polytechnic Dhangawadi, Tal-Bhor, Dist- Pune | 09/02/2022 | 09/02/2022 | 00/01 | 1       |
| 137 | Internship       | Internship             | Rajgad Sahakari Sakhar Karkhana, Nigde, Bhor, Pune                                | 01/10/2021 | 31/10/2021 | 4     | 1 Month |
| 138 | Internship       | Internship             | Anant Dudh Pvt. Ltd., Kikavi, Taluka-Bhor, Dist - Pune                            | 01/12/2021 | 31/12/2021 | 4     | 1 Month |



**Principal**  
Rajgad Dnyanpeeth's  
Shri Chhatrapati Shivajiraje College of Engg.  
Dhangawadi, Pune-412206





INDUSTRIAL VISIT REPORT

Date: 20 /05 / 2022

- 1) Class : B. E. Mechanical Engineering
- 2) Subject : Energy Engineering
- 3) Name of Industry : Dhom Hydro Power Station
- 4) Date & Time : 19<sup>th</sup> May 2022 (10AM to 2PM)
- 5) Present Students : 40
- 6) Name of Faculty : Prof. S. B. Jamdar

As a part of Savitribai Phule Pune University academic curriculum it required Industrial visit to any Hydro Power Station, so we have arranged a visit to Dhom Hydro Power Station, Tal- Wai, Dist- Satara.

Content of Studies:

- 1) Dhom Hydro Power Station, Tal- Wai, Dist- Satara uses Francis Water Turbine because this dam is at height of 50m. The water capacity of lake is 14TMC.
- 2) There are two units having capacity of 1MW each unit. So total capacity of plant is 2MW.

Daily Generation-0.017810 MTS  
Monthly Generation-0.272430 MUS  
F. Y. Generation-0.2724300MUS  
Lake Level-739.01 MTR  
Net Head-14.23 MTR  
Daily Rainfall-00/00/1236 mm

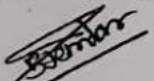

  
(Prof. S. B. Jamdar)  
Subject In-charge



  
(Prof. S. K. Pawar)  
Head of Department  
Dept. of Mechanical Engineering  
Shri Chh. Shivajiraje College of Engg.  
Dhangawadi, Pune-412206



Rajgad Dnyanpeeth's  
**SHRI CHHATRAPATI SHIVAJIRAJE COLLEGE OF  
ENGINEERING**

S. No. 237, Satara-Pune, NH-4, Dhangawadi, Tal: Bhor, Dist: Pune

**INDUSTRIAL VISIT REPORT**

**At**

**TE Connectivity India Private Limited  
Shirwal, Pune.**

**(For A.Y. - 2021-22)**

**Savitribai Phule Pune University Pune, India**





Rajgad Dnyanpeeth's

**SHRI CHHATRAPATI SHIVAJIRAJE COLLEGE OF ENGINEERING**

Gat No. 237, Pune Bangalore Highway, Dhangawadi, Tal – Bhor, Dist- Pune (Maharashtra)

Dept.: E&TC Engineering

Date: - 17<sup>th</sup> May 2022

Academic Year: 2021-22

### Industrial Visit Report

- 1) **Class:** B.E, T.E E&TC
- 2) **Name of Company:** TE Connectivity India Pvt Ltd. Guthalwadi, Shirwal Maharashtra.
- 3) **Date & Time:** Tuesday, 17/5/2022, 10:00 a.m to 4:00 p.m.
- 4) **Present Students:** 50/2 Batches (Total-50 Students).
- 5) **Contact Person with Designation & Phone No.:** Ms. Asha Shelke-HR Associates,  
09512856970
- 6) **Name of Faculty:** Prof. S. D.Pasalkar & Prof. L.M.Sagle.

#### Industry Profile:



**TE Connectivity India Pvt. Ltd.** is a quality driven organization offering a wide range of 4 wheeler wire harness, cable assemblies, amp seal connectors, heavy duty connectors.

TE Connectivity is a technology company that designs and manufactures connectivity and sensor products for harsh environments in a variety of industries, such as automotive, industrial equipment, data communication systems, aerospace, defense, medical, oil and gas, consumer electronics and energy.

We believe in the power of a diverse, inclusive organization. Across TE, we demonstrate our commitment to this belief every day. Our leadership team reflects and champions this belief.

Our teams work closely together – across functions and regions – to meet the needs of customers, shareholders, partners, and employee



## Objective of the Event

On 17<sup>th</sup> May, 2022, an industrial visit for “TE Connectivity India Pvt Ltd” was organized as a part of student’s curriculum for “Electronics Product Design” E&TC engineering department. Total 50 students participated in this industrial visit.

This TE Connectivity India Pvt. Ltd. industrial visit for students was guided and accompanied by Prof. S.D.Pasalkar and Prof. L.M.Sagle. The main focus of this industrial visit is to fill the bridge between technical concepts taught in curriculum and industry applied concepts. Various technical concepts were discussed with the students which are applied in the field of industrial equipment, data communication systems.

## Outcome of the Event:

All students reached TE Connectivity India Pvt. Ltd. by 11:00 AM on 17/5/2022 along with faculty coordinators. The students were guided to the basic knowledge wire harness, cable assemblies, sensor products, automotive, industrial equipment, data communication systems, aerospace, defense, medical, oil and gas, consumer electronics and energy. All students were divided into small batches of 15. Training supervisor Mr. Anup from TE Connectivity India Pvt. Ltd accompanied students group and showed them control room, line production of drives and company Videos. Depending on the data and details given from TE Connectivity India Pvt. Ltd supervisors, students were instructed to prepare brief report of industrial visit.

## Visit Photographs:





Group Photo.

Prof. S.D. Pasalkar  
Faculty In-charge



Prof. T.M. Dudhane  
H.O.D

**Head of Department**  
Dept. of E& TC Engineering  
Shri Chh. Shivajiraje College of Engg  
Dhangawadi, Pune-412206



Date-11/05/2022

**DEPARTMENT OF CIVIL ENGINEERING**

**NOTICE**

We are organizing an Industrial Visit for Third year students of Civil department at, **Thermal faecal sludge treatment Plant**, Wai Taluka - Wai, Dist-Satara At date 13/05/2022 (Friday). Timing-11am to 2:30 pm. There will be no classes for those students who will attend the visit on that day. Students are required to be in formal and carry their Identity card.

Following faculty members will accompany the students on Industrial visit:

1. Prof. P.G.Gaikwad
2. Prof. G.S. Yadav

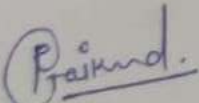
  
Coordinator

Prof. P.G.Gaikwad

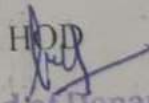

  
HOD  
**Head of Department**  
Dept. of Civil Engineering  
Shri Chh. Shivajiraje College of Engg.  
Dhangawadi, Pune-412206



# Shri Chhatrapati Shivajiraje College of Engineering

Approved by the State Government, Maharashtra, Ministry of Education, Pune  
Pune University, Pune-411 004. (Regulation No. 2001-2002) (S.No. 1750) (Date: 11-05-2002)



Vice-Chancellor, Phule  
Founder-President, Ex. Edu. Minister

Sanjay M. Thopte  
M.A. Executive President

Dr. Bhagwati Prasad  
Hon. Secretary

Dr. S. B. Patil  
Principal

RD/SCSCOE/CIVIL/VISIT/2021-22/32

Date: 11/05/2022

To,  
The Chief Officer  
Municipal Council Wai,  
Wai, Satara.

Subject: - Regarding permission for academic site visit.

Respected Sir,

Our Rajgad Dnyanpeeth's, Shri Chhatrapati Shivajiraje College of Engineering, Dhangawadi (Bhor) is affiliated to Savitribai Phule Pune University. As per the curriculum of Savitribai Phule Pune University for Third year students of Civil Engineering, we are planning an academic site visit at your organisation under Waste Water Engineering subject & Solid waste Management.

This visit will enhance the skill of students to encourage the creative thinking process to help them to get confidence about the actual field work. Details about number of students & tentative dates are as follows,

- **Name of Faculty:** Asst. Prof. Poonam G. Gaikwad  
(Contact No 7020354794, Mail id-poonu.gaikwad95@gmail.com)
- **No of Students:** 61
- **No of Faculty members:** 02
- **Tentative Date:** 13-05-2022, Friday

Kindly do the needful.

Thanking you.

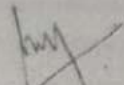
  
Dr. S.S. Sayyed  
HOD

Head of Department

Dept. of Civil Engineering

Shri Chh. Shivajiraje College of Engg.  
Dhangawadi, Pune-412206

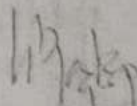

  
Prof. Dr. S. B. Patil  
Principal

Principal

Rajgad Dnyanpeeth's  
Shri Chhatrapati Shivajiraje College of Engg.  
Dhangawadi, Pune-412206



Shri Chhatrapati Shivaji Maharaj College of Engineering  
S. No. 233, Salun-Pune, NE-4, Dhule Road, Tal. Haveli, Dist. Pune

DEPARTMENT OF CIVIL ENGINEERING

Academic Year: 2021-22

Semester - II

Site Visit :-

Thermal faecal sludge treatment Plant, Wal

Attendance Sheet

Class: T.T.C.08

| S. No | Roll No.  | Student Name                   | Signature |
|-------|-----------|--------------------------------|-----------|
| 1     | TC120D001 | AJSAJ, SHREERAJ VJAY           | Ajsaj     |
| 2     | TC120D002 | AGTAL EKNATH PARAJI            | Agtaal    |
| 3     | TC119F001 | ANIFORE TUSHAR ASHISH          | Anifore   |
| 4     | TC120D004 | BANDAI NIKHIL BHARAT           | Nikhil    |
| 5     | TC120D005 | BANDAI SHUBHAM BABURAO         | AB        |
| 6     | TC120D006 | BARGE ABHILEET SUNIL           | Abhileet  |
| 7     | TC120D007 | BHANDALKAR PUJA MANSING        | PBJ       |
| 8     | TC119F008 | BHAVE PANDURANG KISHANRAO      | Bhave     |
| 9     | TC118F009 | BHILARE SAURABH MARUTI         | BSS       |
| 10    | TC118F011 | BUDHE GANESH DNYANDEV          | Constr.   |
| 11    | TC120F012 | CHAUDHARI VIVEK RAJENDRA       | AB        |
| 12    | TC120F014 | CHAVAN ANIKET KESHAV           | Aniket    |
| 13    | TC120F015 | CHAVAN KIRAN YUVRAJ            | Roh       |
| 14    | TC120F016 | CHAVAN ROSHAN NAMDEV           | Roshan    |
| 15    | TC120F017 | CHAVAN VIKAS KASHINATH         | Vikas     |
| 16    | TC120F018 | CHIKANE JAY DATTATRAY          | Chikane   |
| 17    | TC120F019 | CHOUGULE OMKAR BALASAHEB       | AB        |
| 18    | TC120D020 | DEVKATE SAGAR SIDHU            | Sagar     |
| 19    | TC119F021 | DHADVE NIKHIL DILIP            | Nikhil    |
| 20    | TC120D022 | DHAYGUDE JAYESH SAMBHAJI       | Jayesh    |
| 21    | TC120D023 | GADE ROHAN RAJENDRA            | Rohan     |
| 22    | TC120D024 | GIRIGOSAVI JYOTI BALU          | Constr.   |
| 23    | TC120D025 | GUJAR AMOL RAJENDRA            | AB        |
| 24    | TC120D026 | JADHAV AJIT SANJAY             | Amit      |
| 25    | TC120D027 | JADHAV SHITAL SUBHASH          | Shital    |
| 26    | TC120D028 | JADHAV SHUBHAM NAVANATH        | Shubham   |
| 27    | TC118F029 | JAIN KETAN NARENDRAKUMAR       | Ketan     |
| 28    | TC120D030 | JAMDHADE SANKET PRAKASH        | Sanket    |
| 29    | TC119F032 | KADAM PRATIK SATISH            | AB        |
| 30    | TC119F033 | KALE RUTUJA DNYANESHWER        | Rutuja    |
| 31    | TC120D034 | KARALE PRAVIN SUDHIR           | Pravink   |
| 32    | TC120D035 | KATTA SACHIN SANJU             | Sachin    |
| 33    | TC119F036 | KAVACHAT DATTATRAYA ABHIMAN    | Kavach    |
| 34    | TC119F037 | KAZI MUJEEB ARSHAD             | Mujeeb    |
| 35    | TC117F038 | KAZI YASIN YUNUS               | Yasin     |
| 36    | TC120D039 | KOLEKAR AKSHAY DATTATRAY       | AB        |
| 37    | TC120D040 | KOLI MAYURESH SANJAY           | Mayuresh  |
| 38    | TC120D041 | KISHORASAGAR GAJENDRA SAMBHAJI | Kishor    |





| S. No | Roll No.  | Student Name                | Signature       |
|-------|-----------|-----------------------------|-----------------|
| 39    | TC119F042 | KSHIRSAGAR SAURABH SUNIL    | <i>AS</i><br>AB |
| 40    | TC120D043 | KUKADE MANOJ ARVIND         | <i>Manoj</i>    |
| 41    | TC119F044 | LOKHANDE VAIBHAV DILIP      | <i>Manoj</i>    |
| 42    | TC120D045 | MADGUDE SANKET RAJARAM      | <i>Pratik</i>   |
| 43    | TC119F046 | MAHANGARE PRATIK SUDAM      | AB              |
| 44    | TC120D047 | MANE AMIT JAGDISH           | <i>Pratik</i>   |
| 45    | TC120D048 | MANE NAVANATH SOMANNA       | <i>Manoj</i>    |
| 46    | TC119F049 | MOHITE OMKAR SAMBHAJI       | <i>Shrin</i>    |
| 47    | TC120D050 | MOHITE SHITAL SHAMARAO      | <i>Pratik</i>   |
| 48    | TC120D051 | MORE GOURI PRAVIN           | AB              |
| 49    | TC120D052 | MORE RUSHIKESH KARBHANJAN   | <i>Pratik</i>   |
| 50    | TC120D053 | NAVGHANE SOURABH SOPAN      | <i>Pratik</i>   |
| 51    | TC120D054 | NIGADE ATHARVA VIJAY        | <i>Pratik</i>   |
| 52    | TC120D055 | NIGADE SANDESH SURESH       | <i>Pratik</i>   |
| 53    | TC120D056 | PANASARE SHUBHAM NAVANATH   | <i>Pratik</i>   |
| 54    | TC120D057 | PAWAR SAYALI RAVINDRA       | AB              |
| 55    | TC119F058 | PAWAR VISHAL SANJAY         | <i>Pratik</i>   |
| 56    | TC120D059 | PAYGUDE SHUBHAM SANJAY      | <i>Pratik</i>   |
| 57    | TC120D060 | PHARANDE ATISH ASHOK        | <i>Pratik</i>   |
| 58    | TC120D061 | PISAL PRATIBHA UMESH        | AB              |
| 59    | TC120D062 | PISAL SNEHAL CHANDRASHEKHAR | <i>Pratik</i>   |
| 60    | TC120D063 | POWAR NAMDEV TIMANNA        | <i>Pratik</i>   |
| 61    | TC120D064 | RAUT SHUBHAM SANJAY         | <i>Pratik</i>   |
| 62    | TC119F065 | SHILIMKAR MONIKA UDAY       | <i>Pratik</i>   |
| 63    | TC119F066 | SHINDE ADITYA NANDKUMAR     | <i>Pratik</i>   |
| 64    | TC120D069 | SHINDE SHIVANI ASHOK        | <i>Pratik</i>   |
| 65    | TC120D070 | SHINDE SONAM SUBHASH        | <i>Pratik</i>   |
| 66    | TC120D071 | SURYAWANSHI ROHIT RAJENDRA  | AB              |
| 67    | TC120D072 | TANK KARTIK CHANDRAKANT     | <i>Pratik</i>   |
| 68    | TC120D073 | TARU GANESH KRUSHNAKANT     | <i>Pratik</i>   |
| 69    | TC117F074 | UMBARKAR VISHESH-SANTOSH    | AB              |
| 70    | TC120D076 | WADMARE ROHIT ISHVAR        | AB              |
| 71    | TC116D077 | KARCHUNDE RAMESH SUNDERRAO  | <i>Pratik</i>   |
| 72    | TC116D078 | TARU SACHIN ASHOK           | <i>Pratik</i>   |

*Pratik*  
Subject Teacher



Head of Department  
 Head of Department  
 Dept. of Civil Engineering  
 Shri Chh. Shivajiraje College of Engg.  
 Dhangawadi, Pune-412206

| S. No | Roll No   | Student Name                | Signature          |
|-------|-----------|-----------------------------|--------------------|
| 38    | TC119F042 | KADIKAMAR VALARAJU SUNE     | <i>[Signature]</i> |
| 39    | TC120D043 | KUKADE MANU ARVIND          | AB                 |
| 40    | TC119F044 | LOKHANDE VAIBHAV DILIP      | <i>[Signature]</i> |
| 41    | TC120D045 | MADGUDE SANKET RAJARAM      | <i>[Signature]</i> |
| 42    | TC119F046 | MAHANGARE PRATIK SUDAM      | <i>[Signature]</i> |
| 43    | TC120D047 | MANE AMIT JAGDISH           | AB                 |
| 44    | TC120D048 | MANE NAVANATH SOMANNA       | <i>[Signature]</i> |
| 45    | TC119F049 | MOHITE OMKAR SAMBHAJ        | <i>[Signature]</i> |
| 46    | TC120D050 | MOHITE SHITAL SHAMARAO      | <i>[Signature]</i> |
| 47    | TC120D051 | MORE GOURI PRAVIN           | <i>[Signature]</i> |
| 48    | TC120D052 | MORE RUSHIKESH KARBHANJAN   | AB                 |
| 49    | TC120D053 | NAVGHANE SOURABH SOPAN      | <i>[Signature]</i> |
| 50    | TC120D054 | NIGADE ATHARVA VEJAY        | <i>[Signature]</i> |
| 51    | TC120D055 | NIGADE SANDESH SURESH       | <i>[Signature]</i> |
| 52    | TC120D056 | PANASARE SHUBHAM NAVANATH   | <i>[Signature]</i> |
| 53    | TC120D057 | PAWAR SAYALI RAVINDRA       | AB                 |
| 54    | TC119F058 | PAWAR VISHAL SANJAY         | <i>[Signature]</i> |
| 55    | TC120D059 | PAYGUDE SHUBHAM SANJAY      | <i>[Signature]</i> |
| 56    | TC120D060 | PHARANDE ATISH ASHOK        | <i>[Signature]</i> |
| 57    | TC120D061 | PISAL PRATIBHA UMESH        | AB                 |
| 58    | TC120D062 | PISAL SNEHAL CHANDRASHEKHAR | <i>[Signature]</i> |
| 59    | TC120D063 | POWAR NAMDEV TIMANNA        | <i>[Signature]</i> |
| 60    | TC120D064 | RAUT SHUBHAM SANJAY         | <i>[Signature]</i> |
| 61    | TC119F065 | SHILIMKAR MONIKA UDAY       | <i>[Signature]</i> |
| 62    | TC119F066 | SHINDE ADITYA NANDKUMAR     | <i>[Signature]</i> |
| 63    | TC120D069 | SHINDE SHIVANI ASHOK        | <i>[Signature]</i> |
| 64    | TC120D070 | SHINDE SONAM SUBHASH        | <i>[Signature]</i> |
| 65    | TC120D071 | SURYAWANSHI ROHIT RAJENDRA  | AB                 |
| 66    | TC120D072 | TANK KARTIK CHANDRAKANT     | <i>[Signature]</i> |
| 67    | TC120D073 | TARU GANESH KRUSHNAKANT     | <i>[Signature]</i> |
| 68    | TC117F074 | UMBARKAR VISHESH SANTOSH    | AB                 |
| 69    | TC120D076 | WADMARE ROHIT ISHVAR        | AB                 |
| 70    | TC116D077 | KARCHUNDE RAMESH SUNDERRAO  | <i>[Signature]</i> |
| 71    | TC116D078 | TARU SACHIN ASHOK           | <i>[Signature]</i> |

*[Signature]*  
Subject Teacher



Head of Department  
*[Signature]*  
Head of Department  
Dept. of Civil Engineering  
Shri Chh. Shivajiraje College of Engg.  
Dhange, Pune-412206



Dept.: Civil Engineering

Academic Year: 2021-22

SITE VISIT REPORT

Date: - 13/05/2022

- 1) **Class:** T.E Civil
- 2) **Subject:** Waste Water Engineering
- 3) **Name of Site:** Thermal faecal sludge treatment Plant, Wai Taluka -Wai,Dist-Satara
- 4) **Date & Time:** Friday, 13.05.2022 & 11.00 am To 2.30 pm
- 5) **Present Students:**55/02
- 6) **Contact Person with Designation & Phone No.:** Mr.Khopade sir
- 7) **Name of Faculty:** Prof. P.G.Gaikwad, Prof. G. S. Yadav

As a part of academic curriculum, we visited the above site. We observed & studied the following things.

Content of studies:

- i. Study of Waste Water Treatment Plant
- ii. Study of Various Units like activated Sludge process
- iii. Study Disposal Technique , Composting Plant

Sewage treatment or domestic wastewater treatment, municipal wastewater treatment is a type of wastewater treatment which aims to remove contaminants from sewage to produce an effluent that is suitable for discharge to the surrounding environment or an intended reuse application, thereby preventing water pollution from raw sewage discharges. Sewage contains wastewater from households and businesses and possibly pre-treated industrial wastewater. There are a high number of sewage treatment processes to choose from. These can range from decentralized systems including on-site treatment systems to large centralized systems involving a network of pipes and pump stations called sewerage which convey the sewage to a treatment plant. For cities that have a combined sewer, the sewers will also carry urban runoff storm water to the sewage treatment plant. Sewage treatment often involves two main stages, called primary and secondary treatment, while advanced treatment also incorporates a tertiary treatment stage with polishing processes and nutrient removal. Secondary treatment can reduce organic matter (measured as biological oxygen demand) from sewage, using aerobic or anaerobic biological processes.

A large number of sewage treatment technologies have been developed, mostly using biological treatment processes. Engineers and decision makers need to take into account technical and economical criteria, as well as quantitative and qualitative aspects of each alternative when choosing a suitable technology. Often, the main criteria for selection are: desired effluent quality, expected construction and operating costs, availability of land, energy



requirements and sustainability aspects. In developing countries and in rural areas with low population densities, sewage is often treated by various on-site sanitation systems and not conveyed in sewers. These systems include septic tanks connected to drain fields, on-site sewage systems (OSS), vermifilter systems and many more. On the other hand, advanced and relatively expensive sewage treatment plants in cities that can afford them may include tertiary treatment with disinfection and possibly even a fourth treatment stage to remove micro pollutants.

At the global level, an estimated 52% of sewage is treated. However, sewage treatment rates are highly unequal for different countries around the world. For example, while high-income countries treat approximately 74% of their sewage, developing countries treat an average of just 4.2%. The treatment of sewage is part of the field of sanitation. Sanitation also includes the management of human waste and solid waste as well as storm water (drainage) management. The term "sewage treatment plant" is often used interchangeably with the term "wastewater treatment plant".

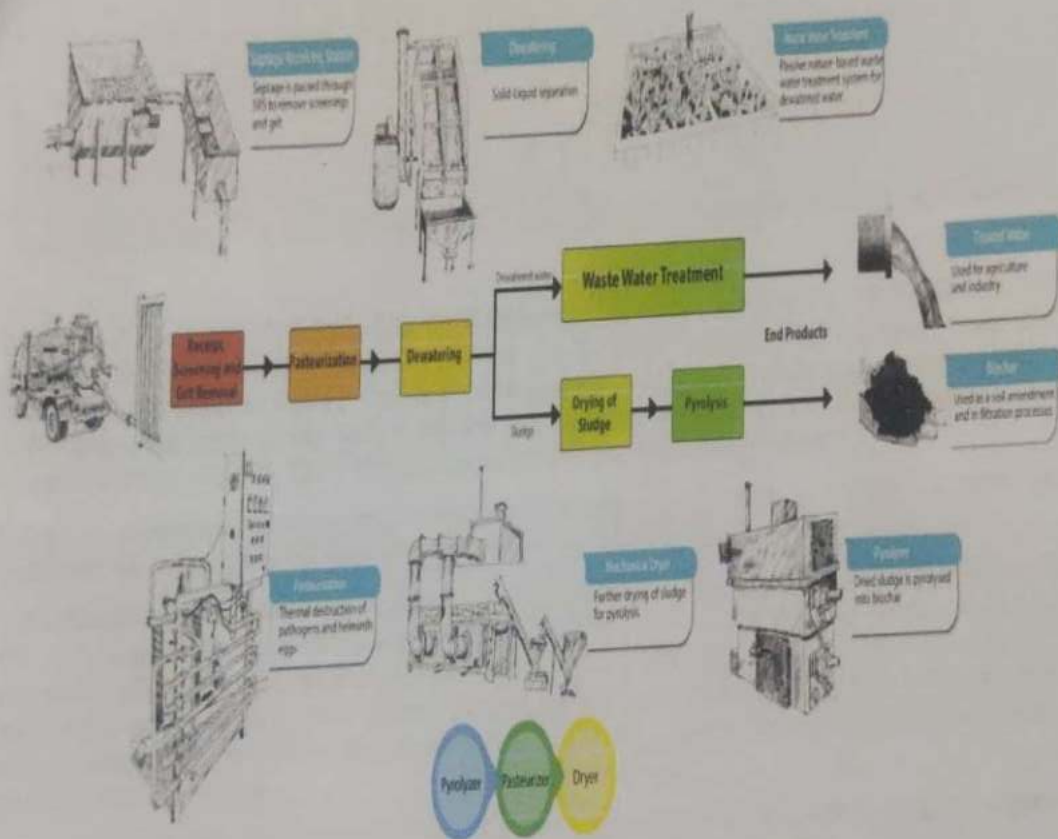

Fig.1 Flow Diagram Of Waste Water Treatment plant





# THERMAL FAECAL SLUDGE TREATMENT PLANT

Wai, Maharashtra



CEPT

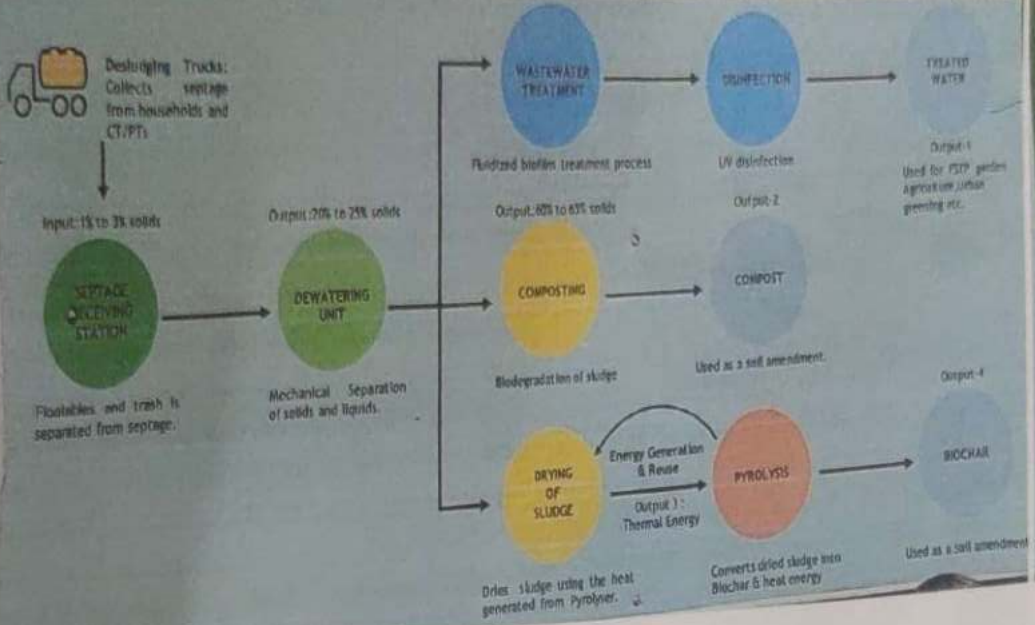

- Wai is a small city in Satara district of Maharashtra, with a population of 43,000 (in 2019). Under Citywide Inclusive Sanitation, Wai Municipal Council with support from CEPT University has become India's first city to implement scheduled desludging of septic tanks at 3 years emptying cycle along with treatment of collected septage at a dedicated Faecal Sludge Treatment Plant (FSTP). The FSTP produces treated wastewater and sludge.
- Due to scheduled emptying high volume of septage is generated. In order to explore some economic or indirect benefit from the plant, the reuse study is being conducted for Wai.
- Maharashtra government has adopted a policy in 2017 that makes municipalities responsible for recycling wastewater and reusing treated wastewater to cool thermal power plants, serve industrial estates, and for other non-potable purposes. ... The municipalities have been given the responsibility of creating a draft action plan regarding the policy within a year and commission the recycling plants within the next three years. The Maharashtra reuse policy was formulated for 71 cities that have STPs.
- However, with 311 FSTPs coming up in Maharashtra and with the state moving to scheduled desludging there will be high volume of treatment, hence reuse policy for FSTP is also necessary.
- The study aims to explore various onsite and offsite reuse options for treated WW and Septage at Wai FSTP. It will identify parameters based on which reuse options can be assessed.
- Experience of Wai will be useful in developing a policy for reuse of treated water from FSTPs in the state







*P.G. Gaikwad*

P.G. Gaikwad  
Faculty In-charge



*Dr. S. Sayyed*  
HOD

Head of Department  
Dept. of Civil Engineering  
Shri Chh. Shivaji Maharaj College of Engg.  
Dhangawada, Pune-412206



## DEPARTMENT OF CIVIL ENGINEERING

### NOTICE

We are organizing an Industrial Visit for Third year students of Civil department at MRF centre at Wai, Tal. Khandala for Solid Waste Management subject. At date 13/05/2022 (Friday). Timing-11am to 2:30 pm

There will be no classes for those students who will attend the visit on that day. Students are required to be in formal and carry their Identity card.

Following faculty members will accompany the students on Industrial visit:

1. Prof. G.S. Yadav
2. Prof. P. G. Gaikwad

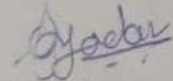
  
Coordinator

Prof. G.S. Yadav

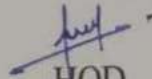

  
HOD

Head of Department  
Dept. of Civil Engineering  
Shri Chh. Shivajiraje College of Engg.  
Dhangawadi, Pune-412206





RD/SOC/ENVT/VI/VISIT/2021-22/15/3

Date: 11/05/2022

To,  
The Chief Officer  
Municipal Council Wai,  
Wai, Satara.

Subject: - Regarding permission for academic site visit.

Respected Sir,

Our Rajgad Dnyanpeeth's, Shri Chhatrapati Shivaji Raj College of Engineering, Dhangawadi (Bhor) is affiliated to Savitribai Phule Pune University. As per the curriculum of Savitribai Phule Pune University for Third year students of Civil Engineering, we are planning an academic site visit at your organisation under Waste Water Engineering subject & Solid waste Management.

This visit will enhance the skill of students to encourage the creative thinking process to help them to get confidence about the actual field work. Details about number of students & tentative dates are as follows,

- Name of Faculty: Asst. Prof. Poonam G. Gaikwad & Ass. Prof. G.S. Yadav  
(Contact No 7020354794, Mail id-poonu.gaikwad95@gmail.com)
- No of Students: 61
- No of Faculty members: 02
- Tentative Date: 13-05-2022, Friday

Kindly do the needful.

Thanking you.

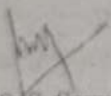
  
Dr. S.A.S. Sayyed  
HOD  
Head of Department  
Dept. of Civil Engineering  
Shri Chhatrapati Shivaji Raj College of Engineering  
Dhangawadi, Pune-412206

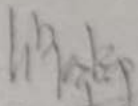

  
Prof. Dr. S.B. Patil  
Principal  
Principal  
Rajgad Dnyanpeeth's  
Shri Chhatrapati Shivaji Raj College of Engineering  
Dhangawadi, Pune-412206





Rajgad Dnyanpeeth's

**SHRI CHHATRAPATI SHIVAJIRAJE COLLEGE OF ENGINEERING**

Gat No. 237, Pune Bangalore Highway, Dhangawadi, Tal - Bhor, Dist- Pune (Maharashtra)

Dept.: Civil Engineering

Academic Year: 2021-22

SITE VISIT REPORT

Date: - 13/05/2022

- 1) **Class:** T.E Civil
- 2) **Subject:** Solid Waste Management
- 3) **Name of Site:** Material Recovery Facility (MRF Center), Tal. Wai, Dist-Satara
- 4) **Date & Time:** Friday, 13.05.2022 & 11.00 am To 2.30 pm
- 5) **Present Students:** 55
- 6) **Contact Person with Designation & Phone No.:** Mr.Khopade sir
- 7) **Name of Faculty** Prof. G. S. Yadav, Prof.P.G.Gaikwad

As a part of academic curriculum, we visited the above site. We observed & studied the following things.

Content of studies:

- i. Study of Solid Waste Management
- ii. Study of Various Units from segregation to composing process
- iii. Study of Machinery used for shredding & bailing machine

Solid waste management is an essential service in any society. Solid waste refers to the range of garbage materials arising from animal & human activities which are discarded as unwanted & useless. Solid waste is generated from industrial, residential, & commercial activities in a given area, maybe handle in a variety of ways. As such landfills R typically classified as sanitary municipal construction and demolition or industrial waste sites.

Waste can be categorized based on material, such as plastic paper, glass, metal, and organic waste. Categorization based on hazard potential, including radioactive, flammable, infectious, toxic, non-toxic wastes. Categories may also pertain to the origin of the waste, whether industrial, domestic, commercial institutional or construction and demolition.

Regardless of the origin, content or hazard potential, solid waste must be managed systematically to ensure environmental best practices. As solid waste management is a critical aspect of environment hygiene, it must be incorporated into environmental planning.



## Process used on site to make compost from solid waste

1. Collection of waste
2. Separation
3. Processing
4. Compost
5. Screening unit



Fig.1 Collection & Separation Unit

- Wai is a small city in Satara district of Maharashtra, with a population of 43,000 (in 2019). Generated solid waste collected from wai city to compost and reuse it.
- In the collection process picking up of solid waste from various sources. a driver and one or two loaders serve each collection vehicle. The collection capacity of wai solid waste management is find 5 ton/ day
- In the separation process the decomposable materials in refuse are isolated from glass, metal, & other inorganic items through sorting and separating





Fig 2 – shredding machine



- In the shredding machine the actual solid waste reduce the waste size, resulting in uniform mass of material. It is accomplished with rotary shredders.

Fig 3- Screening unit



- Bailing press is a dedicated waste management machine that compresses recyclable materials such as paper, cardboard, plastic into dense manageable bundles. A solid waste
- A solid waste processing facility is an operation that changes the chemical, physical or biological, properties of solid waste to make it easier to dispose of or transfer solid waste material.
- Aerobic composting is done in last step. Cultural spray is used to compost the waste. The waste is compost within 30-40 days.



Fig 4- site visit at MRF Centre

The site visit for Solid waste management subject is successfully done at 13.05.2022

Prof. G.S. Yadav  
Faculty In-charge



Dr. S. S. Sayyed  
**HOD**  
**Head of Department**  
Dept. of Civil Engineering  
Shri Chh. Shivajiraje College of Engg.  
Dhangawadi, Pune-412206



Rajgad Dnyanpeeth's  
SHRI CHHATRAPATI SHIVAJIRAJE COLLEGE OF ENGINEERING  
S. No. 237, Satara-Pune, NH-4, Dhargawadi, Tal: Bhor, Dist: Pune

## DEPARTMENT OF CIVIL ENGINEERING

Academic Year: 2021-2022,

Sub: SWM

Semester - II

## Site visit attendance sheet

| Class: T.E.Civil |                  | Name of Site visit coordinator: Prof.G.S.Yadav |           |
|------------------|------------------|--|-----------|
| S. No            | Roll No.         | Student Name                                   | Signature |
| 1                | 25               | Jain Katan Narendrakumar                       |           |
| 2                | 27               | Kadam Pratik Satish                            |           |
| 3                | 35               | Kulkade Manoj Anilrao                          |           |
| 4                | 26               | Jamdhade Santosh Prakash                       |           |
| 5                | 59               | Tane Laxman Channu                             |           |
| 6                | 01               | Adsul Shreeraj Vijay                           |           |
| 7                | 09               | Budhe Ganesha Ananddev                         |           |
| 8                | 08               | Bhilane Saurabh Manuti                         |           |
| 9                | 07               | Bhandalkar Pooja Mansing                       |           |
| 10               | 38               | Mahangare Pratik Sudam                         |           |
| 11               | 18               | Dhadve Nikhil Dilip                            |           |
| 12               | 06               | Bhagwat Yogesh Shrirang                        |           |
| 13               | 03               | Anbhore Tushar Ashish                          |           |
| 14               | 15               | Chikane Jas Dattatraya                         |           |
| 15               | 64               | Migade Sunil Suresh                            |           |
| 16               | 67               | Girigosavi Yash Balu                           |           |
| 17               | 25               | Jadhav Shital Subhash                          |           |
| 18               | <del>24</del> 62 | KARCHUNDE RAMESH                               |           |
| 19               | 63               | Taru Sachin Ashok                              |           |
| 20               | 19               | Dhagude Jayesh Sambhaji                        |           |
| 21               | 14               | Anilset Keshav Aron                            |           |
| 22               | 20               | Gade Rohan Rajendra                            |           |
| 23               | 46               | Pawar Sayali Ravindra                          |           |
| 24               | 51               | Pisal Snehal Chandrabhaker                     |           |
| 25               | 24               | Jadhav Shubham Nannath                         |           |
| 26               | 28               | Kale Rutuja Dnyaneshwar                        |           |
| 27               | 34               | Kshirsagar Saurabh Sunil                       |           |
| 28               | 35               | Omkar Sambhaji Mohite                          |           |
| 29               | 54               | Shilimkar Monika Uday                          |           |
| 30               | 36               | Wolkekar Vaibhav Dilip                         |           |
| 31               | 49               | Pharande Atish Ashok                           |           |
| 32               | 55               | Shinde Aditya Nandkumar                        |           |
| 33               | 39               | Mane Amit Jagdish                              |           |
| 34               | 43               | Pansare Shubham Nannath                        |           |
| 35               | 53               | Raut Shubham Sanjay                            |           |

| S. No | Roll No. | Student Name             | Signature          |
|-------|----------|--------------------------|--------------------|
| 36    | 32       | Atchay Dattatray Kolekar | <i>[Signature]</i> |
| 37    | 68       | Kavchut Dattatray Ashina | <i>[Signature]</i> |
| 38    | 04       | Bandal Nitish Bhasel     | <i>[Signature]</i> |
| 39    | 12       | Kiran Yuvraj Chavan      | <i>[Signature]</i> |
| 40    | 48       | Shubham Sanjay Patil     | <i>[Signature]</i> |
| 41    | 11       | Rohan Umesh Chavan       | <i>[Signature]</i> |
| 42    | 10       | Vivek Rajendra Chavan    | <i>[Signature]</i> |
| 43    | 04       | Ajmal Eknath Patil       | <i>[Signature]</i> |
| 44    | 08       |                          |                    |
| 45    | 28       |                          |                    |
| 46    | 30       |                          |                    |
| 47    | 39       |                          |                    |
| 48    | 02       |                          |                    |
| 49    | 18       |                          |                    |
| 50    | 28       |                          |                    |
| 51    | 36       |                          |                    |
| 52    | 05       |                          |                    |
| 53    | 07       |                          |                    |
| 54    | 42       |                          |                    |
| 55    | 51       |                          |                    |
| 56    | 58       |                          |                    |
| 57    | 28       |                          |                    |
| 58    | 25       |                          |                    |
| 59    | 19       |                          |                    |
| 60    | 12       |                          |                    |
| 61    | 09       |                          |                    |
| 62    |          |                          |                    |
| 63    |          |                          |                    |
| 64    |          |                          |                    |
| 65    |          |                          |                    |
| 66    |          |                          |                    |
| 67    |          |                          |                    |
| 68    |          |                          |                    |
| 69    |          |                          |                    |
| 70    |          |                          |                    |

*[Signature]*  
Site Visit Teacher



*[Signature]*  
Head of Department

Head of Department  
Dept. of Civil Engineering  
Shri Chh. Shivajiraje College of Engg.  
Dhargawadi, Pune-412206

# CERTIFICATE OF COMPLETION

6/5/2022

This certificate is proudly presented to

*Saste Shubham Jalindar*

for successful completion of 1 month internship in  
**Web Development and Designing**  
with wonderful remarks at **OASIS INFOBYTE**

OASIS  
INFOBYTE



contact@oasisinfobyte.in

OIB/MAY/2022

www.oasisinfobyte.com





# CERTIFICATE OF INTERNSHIP

## CERTIFICATE OF COMPLETION



6/3/2022

This certificate is proudly presented to

**Lawande Swapnil Bhalchandra**



for successful completion of 1 month internship in  
**Web Development and Designing**  
with wonderful remarks at **OASIS INFOBYTE**

contact@oasisinfobyte.in    OIBSAY303    www.oasisinfobyte.com



# CERTIFICATE OF COMPLETION

6/3/2022

This certificate is proudly presented to

*Akshada Anil Garud*

for successful completion of 1 month internship in  
Web Development and Designing  
with wonderful remarks at OASIS INFOBYTE

OASIS  
INFOBYTE



contact@oasisinfobyte.in

OIB/MAY209

www.oasisinfobyte.com



# CERTIFICATE OF COMPLETION

6/3/2022

This certificate is proudly presented to

*Prachi Santosh Bobade*

for successful completion of 1 month internship in  
Web Development and Designing  
with wonderful remarks at OASIS INFOBYTE

OASIS  
INFOBYTE



[contact@oasisinfobyte.in](mailto:contact@oasisinfobyte.in)

OIS/MAY/2022

[www.oasisinfobyte.com](http://www.oasisinfobyte.com)



# CERTIFICATE OF INTERNSHIP

## **CERTIFICATE OF COMPLETION**

6/3/2022

This certificate is proudly presented to

**Borane Shubham Sandip**

for successful completion of 1 month internship in  
**Web Development and Designing**  
with wonderful remarks at **OASIS INFOBYTE**

OASIS  
INFOBYTE



[contact@oasisinfobyte.in](mailto:contact@oasisinfobyte.in)

OIB/MAY 2021

[www.oasisinfobyte.in](http://www.oasisinfobyte.in)



# CERTIFICATE OF INTERNSHIP

## **CERTIFICATE OF COMPLETION**

6/3/2022

This certificate is proudly presented to

**Theurkar Priyadarshan Dnyanoba**

for successful completion of 1 month internship in  
**Web Development and Designing**  
with wonderful remarks at **OASIS INFOBYTE**

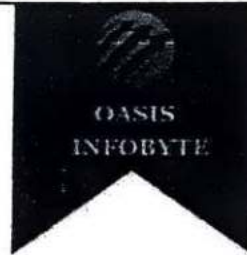

contact@oasisinfobyte.in

OASIS INFOBYTE

www.oasisinfobyte.com



# CERTIFICATE OF COMPLETION

6/3/2022

This certificate is proudly presented to

Mr Chandan Shekhar

for successful completion of **1 month internship in  
Web Development and Designing**  
with wonderful remarks at **OASIS INFOBYTE**



**MSME**  
MICRO, SMALL & MEDIUM ENTERPRISES  
कम. उ. उ. म. उ. उ. उ.

contact@oasisinfobyte.in

OIB/MAY303



www.oasisinfobyte.com

# CERTIFICATE OF COMPLETION

OASIS  
INFOBYTE

6/3/2022

This certificate is proudly presented to

*More Priti Arvind*

for successful completion of **1 month internship** in  
**Web Development and Designing**  
with wonderful remarks at **OASIS INFOBYTE**



✉ [contact@oasisinfobyte.in](mailto:contact@oasisinfobyte.in)

OIB/MAY262



[www.oasisinfobyte.com](http://www.oasisinfobyte.com)



**MSME**  
MICRO, SMALL & MEDIUM ENTERPRISES  
१९५१, १९५२, १९५३, १९५४, १९५५

# CERTIFICATE OF COMPLETION

OASIS  
INFOBYTE

01/06/2022

This certificate is proudly presented to

Dhiraj Anna

for successful completion of **1 month internship** in  
**Web Development and Designing**  
with wonderful remarks at **OASIS INFOBYTE**



contact@oasisinfobyte.in

OIB/MAY303



www.oasisinfobyte.com





# CERTIFICATE OF COMPLETION

OASIS  
INFOBYTE

01/06/2022

This certificate is proudly presented to

Harav Rajendra



for successful completion of **1 month internship** in  
**Web Development and Designing**  
with wonderful remarks at **OASIS INFOBYTE**

✉ [contact@oasisinfobyte.in](mailto:contact@oasisinfobyte.in)

OIB/MAY303



[www.oasisinfobyte.com](http://www.oasisinfobyte.com)





# PRANAV ENTERPRISES

**Specialist in All Types of Milling & Tool Rooms Job Work**

Gat No. 188, Jyotiba Nagar, Talawade, Pune - 412 114

Ref. No.:

Date:

02.06.2022

To.

Mr. Ajinkya Subhash Babar  
(Internship Trainee)

**subject: completion of one month training program**

With reference to your appointment as internship trainee, this is to inform you that, your one year training will be completed on 01.06.2022 and you will be relieved from the training accordingly.

We found him sincere, hardworking, technically sound and result oriented. He worked well as part of a team during his tenure. We take this opportunity to thank him and wish him all the best for future.

You are requested to collect your dues, if any, from our Account Department. on production of necessary clearance certificate.





**NEW YORK JOBS  
CEO COUNCIL**

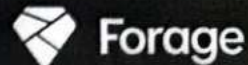

Inspiring and empowering  
future professionals



# Shreya Bhelke

## Cybersecurity Virtual Experience Program

Certificate of Completion

June 3rd, 2022

Over the period of May 2022 to June 2022, Shreya Bhelke has completed practical task modules in:

- Design a phishing email simulation
- Interpret phishing simulation results



**Tom Brunskill**  
CEO, Co-Founder of  
Forage



**NEW YORK JOBS  
CEO COUNCIL**



Inspiring and empowering  
future professionals

# Harshada Jagadale

## Cybersecurity Virtual Experience Program

Certificate of Completion  
June 2nd, 2022

Over the period of May 2022 to June 2022, Harshada Jagadale has completed practical task modules in:

Design a phishing email simulation  
Interpret phishing simulation results



**Tom Brunskill**  
CEO, Co-Founder of  
Forage

Lets  
**Grow/More**  
**CERTIFICATE**  
**of Completion**

CID - LGMVIPWEB0005080

10

PROUDLY PRESENTED TO

**Todkar Omkumar Murlidhar**

**Was an active Participant in the LetsGrowMore Virtual Internship Program  
in Web Development from 1 May 2022 to 1 June 2022**



*Aman Kesariwani*

FOUNDER

5 June 2022



Lets **Grow/More**  
**CERTIFICATE**  
**of Completion**

PROUDLY PRESENTED TO

**Kunal Sunil Umbarkar**

**Was an active Participant in the LetsGrowMore Virtual Internship Program  
in Web Development from 1 May 2022 to 1 June 2022**



*Aman Kesarwani*

FOUNDER

5 June 2022



Lets  
**Grow More**  
**CERTIFICATE**  
of Completion

CID - LGMVIPWEB0004881

PROUDLY PRESENTED TO

**Gawali Kartik Rakesh**

**Was an active Participant in the LetsGrowMore Virtual Internship Program  
in Web Development from 1 May 2022 to 1 June 2022**



*Aman Kesarwani*

FOUNDER

5 June 2022



Lets  
**Grow/More**  
CERTIFICATE  
OF COMPLETION

CID - LGMVIPWEB0005010

PROUDLY PRESENTED TO

**Vidya sambhaji Devgirikar**

Was an active Participant in the LetsGrowMore Virtual Internship Program  
in Web Development from 1 May 2022 to 1 June 2022



*Aman Kesarwani*

FOUNDER

5 June 2022



Verify Here



Lets  
**GrowMore**  
CERTIFICATE  
OF COMPLETION

CID - LGMVIPWEB0004990

PROUDLY PRESENTED TO

**SHUBHAM TARUDATTA BORSARE**

Was an active Participant in the LetsGrowMore Virtual Internship Program  
in Web Development from 1 May 2022 to 1 June 2022



*Aman Kesarwani*

FOUNDER

5 June 2022



Verify Here

Lets  
**GrowMore**  
**CERTIFICATE**  
**of Completion**

CID - LGMVIPWEB0005091

PROUDLY PRESENTED TO

**Sahil Sanjay Kaluse**

**Was an active Participant in the LetsGrowMore Virtual Internship Program  
in Web Development from 1 May 2022 to 1 June 2022**



*Aman Kesarwani*

FOUNDER

5 June 2022



Lets  
**GrowMore**  
**CERTIFICATE**  
**of Completion**

CID - LGMVIPWEBWL0011877

PROUDLY PRESENTED TO

**KIRAN PRAKASH KHANDALE**

Was an active Participant in the LetsGrowMore Virtual Internship Program  
in Java Programming from 1 March 2022 to 1 May 2022



*Aman Kesarwani*

FOUNDER

6 May 2022



# Lets Grow More CERTIFICATE of Completion

PROUDLY PRESENTED TO

## AJIT DATTATRAY KHOPADE

Was an active Participant in the LetsGrowMore Virtual Internship Program  
in Java Programming from 1 March 2022 to 1 May 2022



*Aman Kesarwani*

FOUNDER

6 May 2022



Lets  
**Grow More**  
**CERTIFICATE**  
**of Completion**

CID - LGMVIPWEB0005081

PROUDLY PRESENTED TO

**Makrand Shashikant Kirve**

**Was an active Participant in the LetsGrowMore Virtual Internship Program  
in Web Development from 1 May 2022 to 1 June 2022**



*Aman Kesarwani*

FOUNDER

5 June 2022



Lets  
**GrowMore**  
CERTIFICATE  
of Completion

CID - LGMVIPWEB0005093

PROUDLY PRESENTED TO

**Prathmesh Dilip Kshirsager**

Was an active Participant in the LetsGrowMore Virtual Internship Program  
in Web Development from 1 May 2022 to 1 June 2022



*Aman Kesarwani*

FOUNDER

5 June 2022



Lets  
**Grow More**  
**CERTIFICATE**  
**of Completion**

CID - LGMVIPWEB005082

PROUDLY PRESENTED TO

**Kunal Dilip Mandave**

**Was an active Participant in the LetsGrowMore Virtual Internship Program  
in Web Development from 1 May 2022 to 1 June 2022**



*Aman Kesarwani*

FOUNDER

5 June 2022



Lets  
**Grow More**  
**CERTIFICATE**  
**of Completion**

CID - LGMVIPWEB0005090

PROUDLY PRESENTED TO

**Munde Abhijeet Bhagwat**

**Was an active Participant in the LetsGrowMore Virtual Internship Program  
in Web Development from 1 May 2022 to 1 June 2022**



*Aman Kesarwani*

FOUNDER

5 June 2022







## CERTIFICATE OF INTERNSHIP

# CERTIFICATE OF COMPLETION

5/30/2022

This certificate is proudly presented to

*Vaishnavi Devendra Patil*

for successful completion of 1 month internship in  
**Java Development**  
with wonderful remarks at **OASIS INFOBYTE**



[contact@oasisinfobyte.in](mailto:contact@oasisinfobyte.in)

OID/MAY224

[www.oasisinfobyte.com](http://www.oasisinfobyte.com)





Rajgad Dnyanpeeth's  
**SHRI CHHATRAPATI SHIVAJIRAJE COLLEGE OF  
ENGINEERING**

S. No. 237, Satara-Pune, NH-4, Dhangawadi, Tal: Bhor, Dist: Pune

## INDUSTRIAL VISIT

At

**CEM Electromech Pvt.Ltd. Kasurdi  
Pune.**

**(For A.Y. - 2021-22)**

**Savitribai Phule Pune University Pune, India**





Rajgad Dnyanpeeth's

**SHRI CHHATRAPATI SHIVAJIRAJE COLLEGE OF ENGINEERING**

Gat No. 237, Pune Bangalore Highway, Dhanagawadi, Tal - Dhori, Dist- Pune (Maharashtra)

Dept.: E&TC Engineering

Date: - 28<sup>th</sup> & 29<sup>th</sup> April 2022

Academic Year: 2021-22

### Industrial Visit Report

- 1) **Class:** B.E, T.E E&TC
- 2) **Name of Company:** CEM Electromech Pvt.Ltd. Kasurdi, Maharashtra 412205.
- 3) **Date & Time:** Thursday, Friday, 28<sup>th</sup> & 29<sup>th</sup> April 2022 .11:00 a.m to 3:00 p.m.
- 4) **Present Students:** Day1: 30 Students, Day 2: 30 Students.
- 5) **Contact Person with Designation & Phone No.:** Mr. Venkatesh, Jr. Engineer,  
07385835527
- 6) **Name of Faculty:** Prof. S. Y.Tule & Prof. J.J. Bandal.

As a part of academic curriculum, we visited the above site. We observed & studied the following things.

#### **Industry Profile:**



**CEM Electromech Pvt. Ltd.** is an Electronic Manufacturing Service provider company established in the year 2008 initially as a partnership firm and transformed into Private Limited Company soon by 2011.

*In continuation to accelerate growth & to meet the growing expectations of customer's, CEM acquired its own land in the year 2018 and renovated the existing structure to state of the art facility to suffice the customer expectations. In June 2019 the new plant was completely ready as planned with all supporting infrastructure and CEM started production from July 2019 in this new facility. The state of the art facility is located at newly emerging & developing Industrial zone near Kasurdi village, Khed Shivapur, Pune - 412 205 with a total factory area of 60,000 sq.ft and Plant built up area 25,000 sq.ft*



The Technocrats, who are instrumental in establishing this venture, are having a **wide experience of 30 to 35 years in the field of PCB Assembly, Thick Film Hybrid Integrated Circuits, Power Electronics, Defense application PCBs, Hybrids & modules, Component Screening for space & Defense.**

CEM has successfully completed 12 years of operations in Electronic Manufacturing Services which itself is a big mile-stone considering the fact that the promoters are not from traditional business family and are determined to continue to cross many more Miles-stones in the years to come.

**CEM Electromech Pvt. Ltd aims to provide complete manufacturing solutions to various segments such as Industrial, Automotive, Instrumentation, Defense, Consumer, Textile and Telecom.** CEM will increase the efforts towards part indigenization to support the requirements and reduce the dependency on imports for Defense sector.

**CEM has a strong, dedicated & highly skilled workforce.** Our mission is to continuously upgrade our facility, follow good workmanship standards & supply Zero defect products at a competitive cost.

CEM major business contributing area so far has been automotive sector. Our 95% of the products manufactured to various sectors are RoHS compliance. We at CEM, strictly follow different **Levels of Production & Quality standards as PPM level monitoring, TPM concepts implemented with 5S practices, Kaizen in daily working, FIFO, Red bin meetings, APOP / FMEA** is implemented with timely submissions of PPAP for Automotive products.

**CEM is an ISO 9001 -2015 certified company** and have completed Lean Manufacturing cluster journey of 18 months organized by Mahindra & Mahindra in co-ordination with Minda Industries Ltd, Pune and also Green Supplier to Maruti Suzuki.

## Objective

The main objective of this industrial visit was to bring the students one step closer to the real world of power Electronics, Industrial Electronics and Circuit design and product development in hieratical way using Electronic components and devices. Here, the students were to be brought to understand the concept and working of the various departments of a **CEM Electromech Pvt. Ltd.**

## Key points of the Visit.

The visit was divided into two sections. First is for overall seminar session and second is plant visit. After completion of seminar session Personal from R&D Department guided student to visit Manufacturing kiosk where various manufacturing lines running.



They explained to the students about different equipment's and their working. After that the students were divided in to two teams which then went on to go at all the departments of CEM Electromech Pvt.Ltd.

Premises. There were many posters regarding safety and precautions to be taken during working, including this there were other various posters such that

1. History of CEM Electromech Pvt.Ltd
2. Customers of CEM Electromech Pvt.Ltd
3. Product Manufactured by CEM Electromech Pvt.Ltd
4. Graph of Production Chain/

### **Major Outcomes:**

The main aim of this visit was to introduce the industry outlook of the Electronics premises that they study during their academics. The participants of the visit learned following.

1. Understood the operation and working of the Circuit or Product Manufacturing Company.
2. Understood how components management and selling and production is done by the company.
3. Understood the complete production chain of the company.
4. 4. The outcome of this plant visit was student got to see the things practically which they have studied in Theory and got clarity of concept.

### **Photos:-**



Students Understand the process of Testing PCB





**Functioning SMT Line**

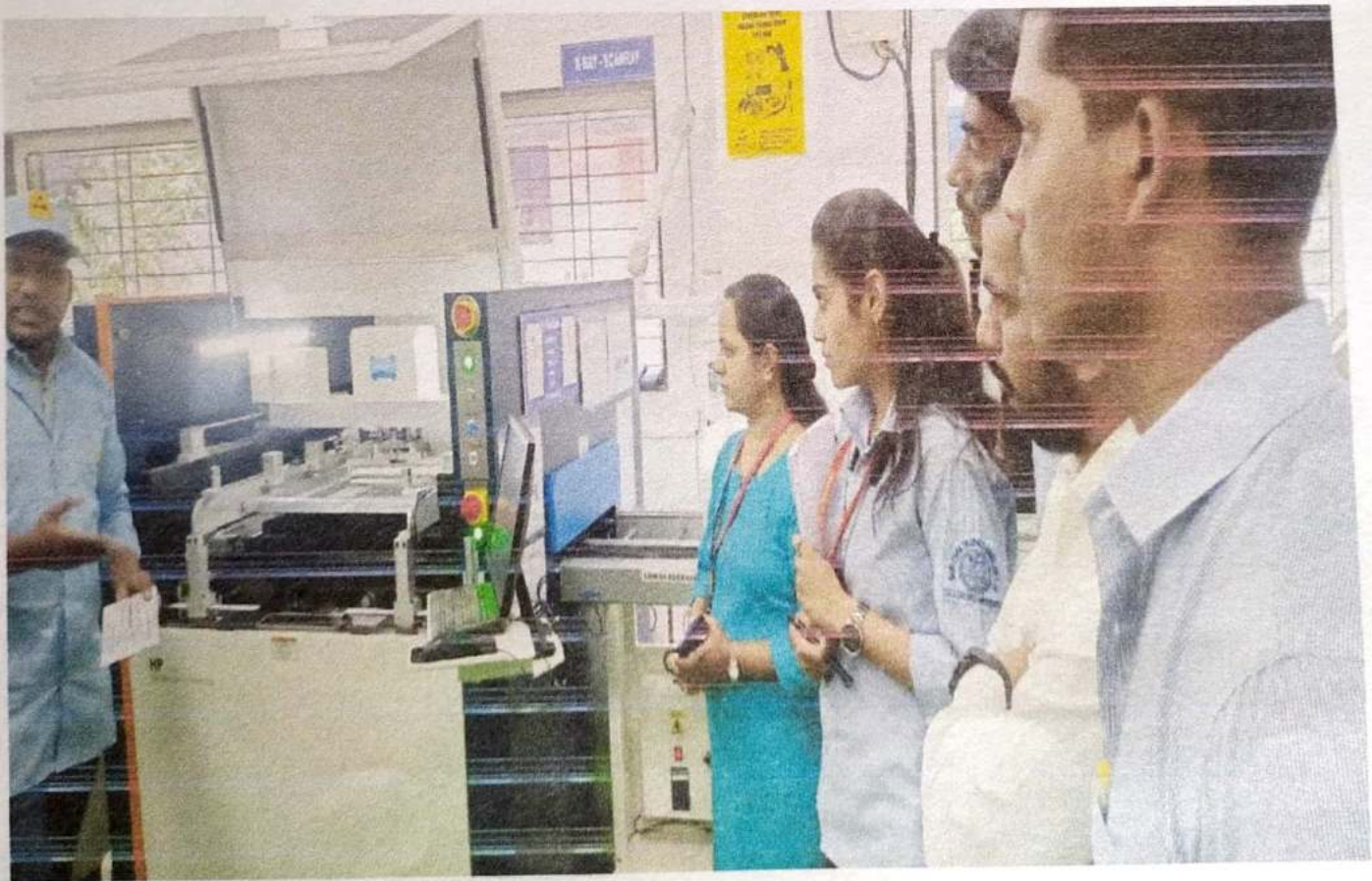

**Mr. Venkatesh Explains working of EOL test setups for products**





**Production Line Setup**



**Group Photo. at CEM Electromech Pvt. Ltd.**

Prof. J.J. Bandal  
Faculty In-charge

Prof. T.M. Dudhane  
**Head of Department**  
Dept. of E& TC Engineering  
Shri Chh. Shivajiraje College of Engg.  
Dhangawadi, Pune-412206



**Officika**

Officika Technologies Pvt. Ltd  
CIN U72900PHT2014PTC152059  
pradeep@officika.com | +91-9960141460 | www.officika.com

Date: 23-05-2022

To,  
Shinde Sandhya Prabhat  
Rajgad Dnyanpeeths Shri Chhatrapati Shivajiraje,  
College Of Engineering, Dhangwadi, Pune

Subject: Certificate of Completion of Internship

This is to certify that Mr./Ms. Shinde Sandhya, student of TE (Computer) has completed his/her One Month Internship with us, from 22<sup>nd</sup> April 2022 to 22<sup>nd</sup> May 2022

As part of his/her internship he/she has completed the basic training on "TSM-ServiceNow" in Officika Technology Pvt.Ltd.(Online mode)

During the tenure with us, we found Mr./Ms. Shinde Sandhya, sincere and result oriented. We wish Mr./Ms. Shinde Sandhya all the best for his/her endeavors.

  
Shrikant Telkar  
Technology Trainer

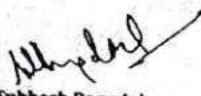

  
Subhash Rangdal  
Director  
Officika Technologies Pvt. Ltd.



Reg. Office: B303 Tirupati Campus, Phase-I,  
Tingre Nagar, Vishrantwadi, Pune 411015 Page 1 of 1







Officika Technologies Pvt. Ltd

CIN #U72900PN2014PTC152059

pradeep@officika.com | +91-9960141460 | www.officika.com

Date: 23-05-2022

To,

Shivatara Harshada Sanjay

Rajgad Dnyanpeeths Shri Chhatrapati Shivajiraje,

College Of Engineering, Dhangwadi, Pune

Subject: Certificate of Completion of Internship

This is to certify that Mr./Ms. Shivatara Harshada, student of TE (Computer) has completed his/her One Month Internship with us, from 22<sup>nd</sup> April 2022 to 22<sup>nd</sup> May 2022

As part of his/her internship he/she has completed the basic training on "ITSM-ServiceNow" in Officika Technology Pvt.Ltd.(Online mode)

During the tenure with us, we found Mr./Ms. Shivatara Harshada, sincere and result oriented. We wish Mr./Ms. Shivatara Hrshada all the best for his/her endeavors.

  
Shrikant Telkar  
Technology Trainer



  
Subhash Rangdal  
Director  
Officika Technologies Pvt. Ltd.



For more details visit our website: www.officika.com  
Officika Technologies Pvt. Ltd. Pune



**Officika**

Officika Technologies Pvt. Ltd  
CIN #U72900PN2014PTC52059  
pradeep@officika.com | +91-9960141460 | www.officika.com

Date: 23-05-2022

To,  
Shilimkar Ashwini Vijay  
Rajgad Dnyanpeetha Shri Chhatrapati Shivajiraje,  
College Of Engineering, Dhangwadi, Pune

**Subject: Certificate of Completion of Internship**

This is to certify that Mr./Ms. Shilimkar Ashwini, student of TE (Computer) has completed his/her One Month Internship with us, from 22<sup>nd</sup> April 2022 to 22<sup>nd</sup> May 2022

As part of his/her internship he/she has completed the basic training on "TSM-ServiceNow" in Officika Technology Pvt.Ltd.(Online mode)

During the tenure with us, we found Mr./Ms. Shilimkar Ashwini, sincere and result oriented. We wish Mr./Ms. Shilimkar Ashwini all the best for his/her endeavors.

  
Srikant Telkar  
Technology Trainer

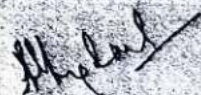

  
Subhash Rangdal  
Director  
Officika Technologies Pvt. Ltd.

Reg. Office: B303 Tirupati Campus, Phase-I,  
Tingre Nagar, Vishrantwadi, Pune 411015

Page 1 of 1





Officika Technologies Pvt. Ltd

CIN #U72900PN2014PTC152059

pradeep@officika.com | +91-9960141460 | www.officika.com

Date: 23-05-2022

To,  
Raut Pooja Sharad  
Rajgad Dnyanpeeths Shri Chhatrapati Shivajiraje,  
College Of Engineering, Dhangwadi, Pune

**Subject: Certificate of Completion of Internship**

This is to certify that Mr./Ms. Raut Pooja, student of TE (Computer) has completed his/her One Month Internship with us, from 22<sup>nd</sup> April 2022 to 22<sup>nd</sup> May 2022

As part of his/her internship he/she has completed the basic training on "ITSM-ServiceNow" in Officika Technology Pvt. Ltd. (Online mode)

During the tenure with us, we found Mr./Ms. Raut Pooja, sincere and result oriented. We wish Mr./Ms. Raut Pooja all the best for his/her endeavors.

  
Shrikant Telkar  
Technology Trainer

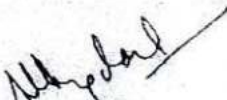

  
Subhash Rangdal  
Director  
Officika Technologies Pvt. Ltd.

Reg. Office: B 103 Tirupati Campus, Phase-1,  
Tingre Nagar, Vishrantwadi, Pune 411015

Page 1 of 1

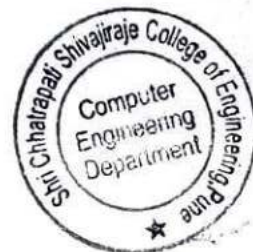

**Officika**

**Officika Technologies Pvt. Ltd**

LIN #U72900PN2014PTC152059  
pradeep@officika.com | +91-9960141460 | www.officika.com

Date: 23-05-2022

To,  
**Tejas Chandrakant Padale**  
**Rajgad Dnyanpeeths Shri Chhatrapati Shivajiraje,**  
**College Of Engineering, Dhangwadi, Pune**

**Subject: Certificate of Completion of Internship**

This is to certify that **Mr./Ms. Padale Tejas**, student of TE (Computer) has completed his/her **One Month Internship** with us, from 22<sup>nd</sup> April 2022 to 22<sup>nd</sup> May 2022

As part of his/her internship he/she has completed the basic training on **"ITSM-ServiceNow"** in **Officika Technology Pvt.Ltd.(Online mode)**

During the tenure with us, we found **Mr./Ms. Padale Tejas**, sincere and result oriented.  
We wish **Mr./Ms. Padale Tejas** all the best for his/her endeavors.

  
**Shrikant Telkar**  
Technology Trainer



  
**Subhash Rangdal**  
Director  
Officika Technologies Pvt. Ltd.

Reg. Office: Rajgad Dnyanpeeths Campus, Phase-1,  
Tingri Nagar, Dhangwadi, Pune 411015

Page 1 of 1



Date: 23-05-2022

To,

**Samarjeet Satish Patankar**

**Rajgad Dnyanpeeths Shri Chhatrapati Shivajiraje,**

**College Of Engineering, Dhangwadi, Pune**

**Subject: Certificate of Completion of Internship**

This is to certify that **Mr./Ms. Patankar Samarjeet**, student of TE (Computer) has completed his/her **One Month Internship with us, from 22<sup>nd</sup> April 2022 to 22<sup>nd</sup> May 2022**

As part of his/her internship he/she has completed the basic training on **"ITSM-ServiceNow"** in **Officika Technology Pvt.Ltd.(Online mode)**

During the tenure with us, we found **Mr./Ms. Patankar Samarjeet**, sincere and result oriented.

We wish **Mr./Ms. Patankar Samarjeet** all the best for his/her endeavors.



**Shrikant Telkar**  
**Technology Trainer**



**Subhash Rangdal**  
**Director**  
**Officika Technologies Pvt. Ltd.**

Reg. Office: B303 Tirupati Campus, Phase-I,  
Tingre Nagar, Vishrantwadi, Pune 411015

Page 1 of 1



To,  
Rukshita Dinesh Bait  
Rajgad Dnyanpeeths Shri Chhatrapati Shivajiraje,  
College Of Engineering, Dhangevadi, Pune

**Subject: Certificate of Completion of Internship**

This is to certify that Mr./Ms. Bait Rukshita, student of TE (Computer) has completed his/her One Month Internship with us, from 22<sup>nd</sup> April 2022 to 22<sup>nd</sup> May 2022

As part of his/her internship he/she has completed the basic training on "ITSM-ServiceNow" in Officika Technology Pvt.Ltd. (Online mode)

During the tenure with us, we found Mr./Ms. Bait Rukshita, sincere and result oriented. We wish Mr./Ms. Bait Rukshita all the best for his/her endeavors.

  
Shrikant Telkar  
Technology Trainer

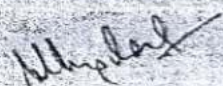

  
Subhash Rangdal  
Director  
Officika Technologies Pvt. Ltd.



Reg. Office: B303 Tinupati Campus, Phase 1,  
Tingre Nagar, Vashranowadi, Pune 411015 Page 1 of 1



Date: 23-05-2022

To,

Ritambara Shankar Chavan

Rajgad Dnyanpeeths Shri Chhatrapati Shivajiraje,

College Of Engineering, Dhangwadi, Pune

**Subject: Certificate of Completion of Internship**

This is to certify that **Mr./Ms. Chavan Ritambara**, student of TE (Computer) has completed his/her **One Month Internship with us, from 22<sup>nd</sup> April 2022 to 22<sup>nd</sup> May 2022**

As part of his/her internship he/she has completed the basic training on **"ITSM-ServiceNow"** in **Officika Technology Pvt.Ltd.(Online mode)**

During the tenure with us, we found **Mr./Ms. Chavan Ritambara**, sincere and result oriented.

We wish **Mr./Ms. Chavan Ritambara** all the best for his/her endeavors.



**Shrikant Telkar**  
Technology Trainer



**Subhash Rangdal**  
Director  
Officika Technologies Pvt. Ltd.



Reg. Office: B303 Tirupati Campus, Phase-I,  
Tingre Nagar, Vishrantwadi, Pune 411015

Page 1 of 1



**Officka**

Officka Technologies Pvt. Ltd

CRM: 91799067204477550971  
pradeep@officka.com | 995094466 | www.officka.com

Date: 23-05-2022

To,

Suryash Sani Dabade

Rajgad Dnyanpeetha Shri Chhatrapati Shivajiraje

College of Engineering, Dhankawadi, Pune

**Subject: Certificate of Completion of Internship**

This is to certify that Mr./Ms. Dabade Suryash, student of TE (Computer) has completed his/her One Month Internship with us, from 22<sup>nd</sup> April 2022 to 22<sup>nd</sup> May 2022.

As part of his/her internship he/she has completed the basic training on "TSM-ServiceNow" in Officka Technology Pvt.Ltd. (Online mode)

During the tenure with us, we found Mr./Ms. Dabade Suryash, sincere and result oriented. We wish Mr./Ms. Dabade Suryash all the best for his/her endeavors.

  
Shrikant Telkar  
Technology Trainer

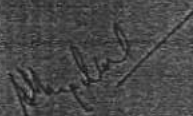

  
Subhash Kangal  
Director  
Officka Technologies Pvt. Ltd.

Reg. Office: B303 Tirupati Campus, Phase-I,  
Tingre Nagar, Vishranawadi, Pune 411015

Page 1 of 1







Officka Technologies Pvt. Ltd

CIN #U72604PN04PTC51059

pradeep@officka.com | 91-9960141460 | www.officka.com

Date: 23-05-2022

To,

Ajinkya Rohidas Dhadave

Rajgad Dnyanpeeths Shri Chhatrapati ShivajiRaje,

College Of Engineering, Dhangwadi, Pune

Subject: Certificate of Completion of Internship

This is to certify that Mr./Ms. Dhadave Ajinkya, student of TE (Computer) has completed his/her One Month Internship with us, from 22<sup>nd</sup> April 2022 to 22<sup>nd</sup> May 2022

As part of his/her Internship he/she has completed the basic training on "ITSM-ServiceNow" in Officka Technology Pvt Ltd. (Online mode)

During the tenure with us, we found Mr./Ms. Dhadave Ajinkya, sincere and result oriented. We wish Mr./Ms. Dhadave Ajinkya all the best for his/her endeavors.

  
Srikant Telkar  
Technology Trainer



  
Subhash Rangdal  
Director  
Officka Technologies Pvt. Ltd.

Reg. Office: B303 Tirupati Campus, Phase-1,  
Tingre Nagar, Vishrantwadi, Pune 411015

Page 1 of 1



Date: 23-05-2022

To,

**Pragati Uddesh Dhadave**

**Rajgad Dnyanpeeths Shri Chhatrapati Shivajiraje,**

**College Of Engineering, Dhangwadi, Pune**

**Subject: Certificate of Completion of Internship**

This is to certify that **Mr./Ms. Dhadave Pragati**, student of TE (Computer) has completed his/her **One Month Internship with us, from 22<sup>nd</sup> April 2022 to 22<sup>nd</sup> May 2022**

As part of his/her internship he/she has completed the basic training on **"ITSM-ServiceNow"** in **Officika Technology Pvt.Ltd.(Online mode)**

During the tenure with us, we found **Mr./Ms. Dhadave Pragati**, sincere and result oriented.

We wish **Mr./Ms. Dhadave Pragati** all the best for his/her endeavors.

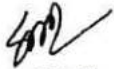

**Shrikant Telkar**  
**Technology Trainer**

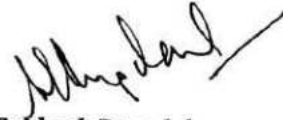

**Subhash Rangdal**  
**Director**  
**Officika Technologies Pvt. Ltd.**

Reg. Office: B303 Tirupati Campus, Phase-I,  
Tingre Nagar, Vishrantwadi, Pune 411015

Page 1 of 1

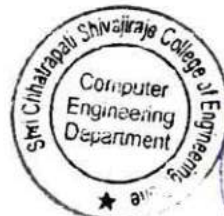

Date: 23-05-2022

To,

Shubhangi Suryakant Gaikwad

Rajgad Dnyanpeeths Shri Chhatrapati Shivajiraje,

College Of Engineering, Dhangwadi, Pune

**Subject: Certificate of Completion of Internship**

This is to certify that **Mr./Ms. Gaikwad Shubhangi**, student of TE (Computer) has completed his/her One Month Internship with us, from 22<sup>nd</sup> April 2022 to 22<sup>nd</sup> May 2022

As part of his/her internship he/she has completed the basic training on "ITSM-ServiceNow" in Officika Technology Pvt.Ltd.(Online mode)

During the tenure with us, we found **Mr./Ms. Gaikwad Shubhangi**, sincere and result oriented. We wish **Mr./Ms. Gaikwad Shubhangi** all the best for his/her endeavors.

  
Shrikant Telkar  
Technology Trainer

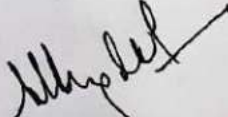

  
Subhash Rangdal  
Director  
Officika Technologies Pvt. Ltd.



Reg. Office: B303 Tirupati Campus, Phase-I,  
Tingre Nagar, Vishrantwadi, Pune 411015

Page 1 of 1



Date: 23-05-2022

To,  
Sushil Pandurang Gaikwad  
Rajgad Dnyanpeeths Shri Chhatrapati Shivajiraje,  
College Of Engineering, Dhangwadi, Pune

**Subject: Certificate of Completion of Internship**

This is to certify that **Mr./Ms. Gaikwad Sushil**, student of TE (Computer) has completed his/her **One Month Internship with us, from 22<sup>nd</sup> April 2022 to 22<sup>nd</sup> May 2022**

As part of his/her internship he/she has completed the basic training on **"ITSM-ServiceNow"** in **Officika Technology Pvt.Ltd.(Online mode)**

During the tenure with us, we found **Mr./Ms. Gaikwad Sushil**, sincere and result oriented.

We wish **Mr./Ms. Gaikwad Sushil** all the best for his/her endeavors.

Shrikant Telkar  
Technology Trainer



Subhash Rangdal  
Director  
Officika Technologies Pvt. Ltd.



Reg. Office: B303 Tirupati Campus, Phase-I,  
Tingre Nagar, Vishrantwadi, Pune 411015



Date: 23-05-2022

To,

Akshada Rajendra Gorad

Rajgad Dnyanpeeths Shri Chhatrapati Shivajiraje,

College Of Engineering, Dhangwadi, Pune

**Subject: Certificate of Completion of Internship**

This is to certify that **Mr./Ms. Gorad Akshada**, student of TE (Computer) has completed his/her One Month Internship with us, from 22<sup>nd</sup> April 2022 to 22<sup>nd</sup> May 2022

part of his/her internship he/she has completed the basic training on "ITSM-ServiceNow" in Officika Technology Pvt.Ltd.(Online mode)

During the tenure with us, we found **Mr./Ms. Gorad Akshada**, sincere and result oriented.

We wish **Mr./Ms. Gorad Akshada** all the best for his/her endeavors.



Shrikant Telkar  
Technology Trainer

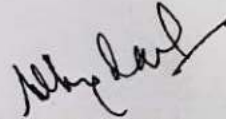

Subhash Rangdal  
Director  
Officika Technologies Pvt. Ltd.



Reg. Office: B303 Tirupati Campus, Phase-I,  
Tingre Nagar, Vishrantwadi, Pune 411015

Page 1 of 1



Date: 23-05-2022

To,

Prashant Mohan Kamble

Rajgad Dnyanpeeths Shri Chhatrapati Shivajiraje,

College Of Engineering, Dhangwadi, Pune

**Subject: Certificate of Completion of Internship**

This is to certify that Mr./Ms. Kamble Prashant, student of TE (Computer) has completed his/her One Month Internship with us, from 22<sup>nd</sup> April 2022 to 22<sup>nd</sup> May 2022

As part of his/her internship he/she has completed the basic training on "ITSM-ServiceNow" in Officika Technology Pvt.Ltd.(Online mode)

During the tenure with us, we found Mr./Ms. Kamble Prashant, sincere and result oriented. We wish Mr./Ms. Kamble Prashant all the best for his/her endeavors.

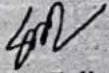

Shrikant Telkar  
Technology Trainer

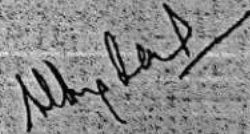

Subhash Rangdal  
Director  
Officika Technologies Pvt. Ltd.



Reg. Office: B303 Tirupati Campus, Phase-I,  
Tingre Nagar, Vishrantwadi, Pune 411015





# Rajgad Dnyanpeeth's Shri Chhatrapati Shivajiraje College of Engineering

Approved by AICTE, New Delhi, Recognized by Govt. of Maharashtra and Affiliated to Savitribai Phule Pune University, Pune (ID. PU/PN/Engg./376/2009), DTE CODE: EN6324, AISHE CODE : C-41588

14

Since - 1972

Anantrao Thopte  
Founder President, Ex. Edu. Minister

Sangram Thopte  
MLA, Executive President

Dr. Bhagyashri Patil  
Hon. Secretary

Dr. S. B. Patil  
Principal

RDTC/SCSCOE/FE/2021-22/ 326

Date: 19/04/2022

To  
The Authority,  
Science Park Pimpari Chinchwad  
Pune.

**Subject:** Permission for visit at Science Park

Respected Sir/Madam,

On behalf of Rajgad Dnyanpeeth's Shri Chhatrapati Shivajiraje College of Engineering, Dhangawadi Pune, where I serve as the Principal wish to request for the permission to conduct a visit at science park on **Tuesday, 19 April 2022 at 11:30 a.m.** We believe that students will get relevant practical knowledge and better understanding of various concepts during this visit. A group of approximately **121 students** from F.E. class along with **6 faculties** intend to participate in this visit.

Kindly allow them to visit at Science Park and also sanction appropriate concession in entry fee.

Thanking you



Your's sincerely,

Prof. Dr. S.B. Patil

**Principal**

Rajgad Dnyanpeeth's  
Shri Chhatrapati Shivajiraje College of Engg.,  
Dhangawadi, Pune-412206



Rajgad Dnyanpeeth's  
**SHRI CHHATRAPATI SHIVAJIRAJE COLLEGE OF ENGINEERING**  
S. No. 237, Satara-Pune, NH-4, Dhangawadi, Tal: Bhor, Dist: Pune

**DEPARTMENT OF FIRST YEAR ENGINEERING**

**A.Y. 2021-22**

**Date: 06/04/2022**

To,  
The Principal,  
Shri Chhatrapati Shivajiraje College of Engineering,  
Dhangawadi, Pune.

**Subject: Permission for visit and requirement of buses.**

Respected Sir,

As per University norms, we have to conduct Induction function for Semester II. In this concern we are organizing the visit of First Year Engineering students at **Pimpri Chinchwad Science Park, District Pune, on Tuesday, 19 April 2022.** This visit might help the students in attaining good knowledge in desired field and making it easy for them to understand the various concepts.

We will depart at 10:30 a.m. from college and return at 5:00 p.m. (Approximately) to college.

We ensure all the students and faculties will definitely maintain the discipline at the place and will strictly follow the rules and regulations. So we request you to grant us the permission in reference to the subject mentioned above and requirement of 2 buses (if required additional one mini bus).

Thank you for your time and consideration.

  
Coordinator  
Prof. S.D. Thorbole



  
Head of Department  
Prof. J.G. Kale

Estate Manager / Transport Incharge  
Kindly do the needful @ 06/04/2022

Salmale  
20952117  
21/2/17  





# Rajgad Dnyanpeeth's Shri Chhatrapati Shivajiraje College of Engineering

Approved by AICTE, New Delhi, Recognized by Govt. of Maharashtra and Affiliated to Savitribai Phule  
Pune University, Pune (ID. PU/PN/Engr./376/2009), DTE CODE: EN6324, AISHE CODE : C-41588



Anantrao Thopte  
Founder President, Ex. Edu. Minister

Sangram Thopte  
MLA, Executive President

Dr. Bhagyashri Patil  
Hon. Secretary

Dr. S. B. Patil  
Principal

RDTC/SCSCOE/FE/2021-22/ \_\_\_\_\_

Date: 19/04/2022

To  
The Authority,  
Science Park Pimpri Chinchwad  
Pune.

**Subject:** Permission for visit at Science Park

Respected Sir/Madam,

On behalf of Rajgad Dnyanpeeth's Shri Chhatrapati Shivajiraje College of Engineering, Dhangawadi Pune, where I serve as the Principal wish to request for the permission to conduct a visit at science park on **Tuesday, 19 April 2022 at 11:30 a.m.** We believe that students will get relevant practical knowledge and better understanding of various concepts during this visit. A group of approximately **121 students** from F.E. class along with **6 faculties** intend to participate in this visit.

Kindly allow them to visit at Science Park and also sanction appropriate concession in entry fee.

Thanking you



Your's sincerely,

Prof. Dr. S.B. Patil

Principal

Rajgad Dnyanpeeth's  
Shri Chhatrapati Shivajiraje College of Engg.,  
Dhangawadi, Pune-412206

visited on 19/04/22  
Thanks

Rajgad Dnyanpeeth's

**SHRI CHHATRAPATI SHIVAJIRAJE COLLEGE OF ENGINEERING**

Gat No. 237, Pune Bangalore Highway, Dhangawadi, Tal - Bhor. Dist- Pune (Maharashtra)

---

**Department of First Year Engineering**

**Academic Year 2021-22**

**Visit Report**

**Class:-FE**

**Subject:-** System in Mechanical Engineering

**Place of Visit:** Pimpri Chinchwad Science Park, Near Auto Cluster, Chinchwad, Pune- 411019.

**Visit Date:** 19-04-2022 (tuesday), Time: 11.00am to 03.00pm

**Present Students:**105

**Guide Name:** Prof.S.D.Thorbole. & Prof. R.B.Raut

Pimpri Chinchwad Science Park is one of the latest tourist attraction and activity based Science Centre of Pune region. The Science Centre houses Galleries on different themes of Science & Technology, Activity area, Inflatable Taramandal and an Auditorium. It also has a open air Science Park spread over 3.5acres. Most of the exhibits in the science centre and science park are interactive in nature and visitors can explore science in an entertaining way.

The Centre also conducts many Science shows such as 3D Shows, Taramandal Shows and Live Demonstrations for visiting people and student groups. It also organises activity based programmes and workshops for students and teachers.

The Science Park is a non-formal educational institution to communicate developments in Science & Technology among the masses, and encourage creativity and spirit of enquiry among the students. Apart from providing effective environment for non-formal science education Pimpri Chinchwad Science Park is sure to enthuse and excite the people especially



students of the region creating awareness on important topical issues in science, technology and engineering.

The Science Centre has 4 Galleries on different subjects.

### 1. Automobiles

The 600 sq.m. gallery comprises of interesting exhibits in the form of interactive, kiosks, cut section models providing opportunities to peep into automobiles, 3D dioramas and exhibits explaining how automobile stuffs like spark plug, injector, silencers, wipers etc. work. Opportunity for virtual driving, testing your skills normally used in driving and activities on making of an automobile will certainly enthuse visitors.



## 2. Energy

In this exposition, spread over 400sq.m., various forms of energy, their production and practical applications, environmental issues, world energy reserves and future sources of energy are explained through various interactive exhibits, working models and multimedia presentation with added components in them.



## 3. Fun science

The Fun Science Gallery, spread over an area of 600 sq m, is full of opportunities for visitors to interact, explore and experience various aspects of science in highly entertaining ambience. Most of the exhibit here are participatory which provide hands-on and minds-on experience to visitors and helps to clear basic concepts of Science.





#### 4. Climate change

The temporary exhibition on Climate Change explains the natural volcanic eruptions, Earth's tilt, continental drift and manmade causes like green house effect, deforestation, suggesting climate change and its consequences on land, air, ice, ocean and inhabitants of Earth. Visitor can learn about difference between weather and factors affecting climate, interaction between components of climate system etc. are also explained.



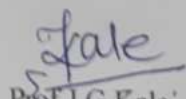

  
 Prof. S.D. Thorbole  
 Subject Teacher

  
 Prof. J.G. Kale  
 Head of Department  
 First Year Engineering  
 Shri Chh. Shivajiraj College of Engg  
 Dhangawadi, Pune-412206





**Rajgad Dnyanpeeth's**  
**SHRI CHHATRAPATI SHIVAJIRAJE COLLEGE**  
**ENGINEERING**

Gat No. 237, Satara-Pune, NH-4, Dhangawadi, Tal: Bhor, Dist: Pune

**DEPARTMENT OF FIRST YEAR ENGINEERING**

**Academic Year: (2021-22)**

Attendance

**Class: FE**

| S. No | Roll No. | Student Name                 |   |
|-------|----------|------------------------------|---|
| 1     | FE21001  | Adsul Swarup Sunil           | P |
| 2     | FE21002  | Ambike Atul Vilas            | P |
| 3     | FE21003  | Andhalikar Akshada Yashwant  | P |
| 4     | FE21004  | Ansari Hasnain Haidar        | P |
| 5     | FE21005  | Bansode Niranjan Shrikrishna | P |
| 6     | FE21006  | Belhekar Mahesh Sunil        | P |
| 7     | FE21007  | Beloshe Atharv Ramesh        | P |
| 8     | FE21008  | Bhagat Dikshant Ravindra     | A |
| 9     | FE21009  | Bhandalkar Aniket Pramod     | P |
| 10    | FE21010  | Bhandalkar Kiran Bhanudas    | P |
| 11    | FE21011  | Bhargude Tanmay Pandurang    | P |
| 12    | FE21012  | Bhilare Pooja Kisan          | P |
| 13    | FE21013  | Bhoite Sanket Sanjay         | P |
| 14    | FE21014  | Bhosale Digvijay Ramesh      | P |
| 15    | FE21015  | Bhosale Shreya Sanjay        | P |
| 16    | FE21016  | Birdawade Rohit Sandip       | P |
| 17    | FE21017  | Bire Akash Sachin            | P |
| 18    | FE21018  | Bodare Aniket Ganesh         | P |
| 19    | FE21019  | Borkar Sameer Bhanudas       | P |
| 20    | FE21020  | Budgude Shravanee Navnath    | A |
| 21    | FE21021  | Chavan Simran Umesh          | A |
| 22    | FE21022  | Chivhe Sanket Sambhaji       | A |
| 23    | FE21023  | Dabhole Atharva Gajanan      | P |
| 24    | FE21024  | Danavale Rutik Sunil         | P |
| 25    | FE21025  | Dere Ekata Santosh           | A |
| 26    | FE21026  | Deshmukh Adesh Hemant        | P |
| 27    | FE21027  | Dhaigude Aditya Ganpat       | P |
| 28    | FE21028  | Dhamal Aditya Rohidas        | P |
| 29    | FE21029  | Dhumal Aniket Dnyaneshwar    | P |



| S. No | Roll No. | Student Name                |   |
|-------|----------|-----------------------------|---|
| 30    | FE21030  | Dhumal Shivanjali Santosh   | P |
| 31    | FE21031  | Doiphode Harshada Tukaram   | P |
| 32    | FE21032  | Dudhane Devang Dattatray    | P |
| 33    | FE21033  | Gade Gaurav Baburao         | P |
| 34    | FE21034  | Gaikwad Neha Ajay           | A |
| 35    | FE21035  | Gaikwad Rachana Amol        | P |
| 36    | FE21036  | Gaikwad Sakshi Bhimaji      | P |
| 37    | FE21037  | Gajbhiye Sahil Hansraj      | P |
| 38    | FE21038  | Garje Ramdas Vitthal        | P |
| 39    | FE21039  | Gawade Sahil Sham           | P |
| 40    | FE21040  | Ghuge Aniket Nanabhau       | P |
| 41    | FE21041  | Gole Mayuri Santosh         | P |
| 42    | FE21042  | Gole Pradnya Laxman         | P |
| 43    | FE21043  | Gole Shruti Sunil           | A |
| 44    | FE21044  | Gopad Eshwar Abhay          | P |
| 45    | FE21045  | Guttedar Sahil Shivling     | P |
| 46    | FE21046  | Haral Apurva Sandip         | P |
| 47    | FE21047  | Hoval Vijay Vikas           | P |
| 48    | FE21048  | Jadhav Rutuja Ashok         | A |
| 49    | FE21049  | Jagadale Aniket Chandrakant | P |
| 50    | FE21050  | Jagtap Aditya Sanjay        | P |
| 51    | FE21051  | Jagtap Saurav Pramod        | P |
| 52    | FE21052  | Jangid Rohan Biharilal      | P |
| 53    | FE21053  | Jedhe Deep Satish           | P |
| 54    | FE21054  | Kadam Sushant Prataprao     | P |
| 55    | FE21055  | Karape Milind Nitin         | P |
| 56    | FE21056  | Karape Nikita Nitin         | P |
| 57    | FE21057  | Kasabe Akshay Shahadev      | P |
| 58    | FE21058  | Kashid Vaishnavi Vilas      | P |
| 59    | FE21059  | Katkar Rutuja Shankar       | P |
| 60    | FE21060  | Khaladkar Deepak Sampat     | P |
| 61    | FE21061  | Khamkar Vivek Suresh        | P |
| 62    | FE21062  | Khan Arbaz Khurshid         | P |



## Attendance

| S. No | Roll No. | Student Name                 |   |
|-------|----------|------------------------------|---|
| 63    | FE21061  | Khamkar Vivek Suresh         | P |
| 64    | FE21062  | Khan Arbaz Khurshid          | P |
| 65    | FE21063  | Khandagale Avishkar Satish   | P |
| 66    | FE21064  | Kharat Maheshwari Jayvant    | P |
| 67    | FE21065  | Khopade Sakshi Suresh        | P |
| 68    | FE21066  | Kolapkar Mangesh Kakasaheb   | P |
| 69    | FE21067  | Konde Rutik Lahu             | P |
| 70    | FE21068  | Kondhalkar Dipak Pandurang   | P |
| 71    | FE21069  | Kshirsagar Samruddhi Umesh   | P |
| 72    | FE21070  | Kudale Omkar Sampat          | P |
| 73    | FE21071  | Kumbhar Kedar Dattatray      | P |
| 74    | FE21072  | Kute Aniket Bandu            | P |
| 75    | FE21073  | Magar Pranoti Mahadev        | P |
| 76    | FE21074  | Mahajan Kaushal Shamkant     | P |
| 77    | FE21075  | Mangutkar Abhishek Sambhaji  | P |
| 78    | FE21076  | Mankar Priyanka Bharat       | P |
| 79    | FE21077  | Margaje Rutuja Rajendra      | P |
| 80    | FE21078  | Mhaske Preeti Dnyaneshwar    | P |
| 81    | FE21079  | Mirde Abrar Musa             | P |
| 82    | FE21080  | Mohite Akanksha Sudhakar     | P |
| 83    | FE21081  | Mohite Hrishikesh Shrinivas  | A |
| 84    | FE21082  | More Ankita Sudam            | P |
| 85    | FE21083  | More Pratik Pandurang        | P |
| 86    | FE21084  | Mujumale Shravani Chintamani | A |
| 87    | FE21085  | Nevase Komal Bhauso          | P |
| 88    | FE21086  | Nigade Utkarsh Uday          | P |
| 89    | FE21087  | Nikam Aditya Rajendra        | A |
| 90    | FE21088  | Parthe Durgesh Bharat        | P |
| 91    | FE21089  | Patil Preeti Mahaveer        | P |
| 92    | FE21090  | Pawar Prajakta Vilas         | P |
| 93    | FE21091  | Phadatare Arpita Sunil       | A |
| 94    | FE21092  | Pol Rutuja Rajaram           | P |
| 95    | FE21093  | Popale Vaishnavi Pandurang   | P |
| 96    | FE21094  | Raval Shraddha Bankim        | P |
| 97    | FE21095  | Rithe Sanket Prashant        | A |



| S. No | Roll No. | Student Name              |   |
|-------|----------|---------------------------|---|
| 98    | FE21096  | Ruchke Baba Bhausahab     | P |
| 99    | FE21097  | Salekar Omkar Dattatray   | P |
| 100   | FE21098  | Salunkhe Anuja Dhanaji    | A |
| 101   | FE21099  | Salunkhe Prachi Balasaheb | A |
| 102   | FE21100  | Satav Rohan Devidas       | P |
| 103   | FE21101  | Sawant Omkar Prasad       | P |
| 104   | FE21102  | Sayyad Amaan Rafik        | A |
| 105   | FE21103  | Shelke Aniket Shivaji     | P |
| 106   | FE21104  | Shinde Anand Balasaheb    | A |
| 107   | FE21105  | Shinde Omkar Suresh       | P |
| 108   | FE21106  | Shingade Aniket Dagdu     | P |
| 109   | FE21107  | Tagad Suyash Anil         | P |
| 110   | FE21108  | Tanpure Shivam Ramchandra | P |
| 111   | FE21109  | Tekawade Pranav Ramesh    | P |
| 112   | FE21110  | Thite Avishkar Santosh    | P |
| 113   | FE21111  | Thite Jayvant Dattatray   | P |
| 114   | FE21112  | Upparbawde Sneha Rajkumar | P |
| 115   | FE21113  | Vare Sahil Rohidas        | P |
| 116   | FE21114  | Veer Sahil Nilesh         | P |
| 117   | FE21115  | Vibhute Yash Jitendra     | P |
| 118   | FE21116  | Vishwakarma Vinod Bharat  | A |
| 119   | FE21117  | Vyahalkar Digant Abhijeet | A |
| 120   | FE21118  | Waghmare Sahil Kishor     | P |
| 121   | FE21119  | Yadav Shreyas Chandrakant | P |
| 122   | FE21120  | Yewale Shivam Ramakant    | P |
| 123   | FE21121  | Zanje Aditi Shivaji       | P |



Mfg. of :  
HDPE / PP CIR. WOVEN  
LAMINATED / NON LAMINATED  
BAGS, TARPULINS & POND LINERS



Prayag Bungalow,  
Opp. Kadepathar Kaman,  
Jejuri-Saswad Rd.,  
Jejuri, Tal. Purandar, Dist Pune.  
Mobile : 9822094741

Ref. No. :

Date :

## Internship Certificate

Date: - 04/06/2022

From,

Raj Polyfabrics Pvt. Ltd.

Jejuri-412303.

To,

Rushikesh D. Pawar.

Jejuri.

**Sub:** Regarding your Internship in our company electrical maintenance Department.

Dear Rushikesh,

We would like to confirm that your application for Internship for the position of maintenance Executive in Electrical Department has been accepted. Here the terms of Internship while working with the company.

1. Duration of Internship will be from 15 April 2022 to 18 May 2022.
2. From time to time your Performance will be evaluated and based on the incentives will be decided.
3. During Internship you are expected to abide code of conduct prescribed by the company of all employees.

You're requested to submit your acceptance to the terms mentioned above as confirmation of your Internship.

Sincerely

For, Raj Polyfabrics Pvt. Ltd.



# RAJ POLYFABRICS PVT. LTD.

Mfg. of :  
HDPE / PP CIR. WOVEN  
LAMINATED / NON LAMINATED  
BAGS, TARPAULINS & POND LINERS



Prayag Bunglow,  
Opp. Kadepathar Kaman,  
Jejuri-Saswad Rd.,  
Jejuri, Tal. Purandar, Dist Pune.  
Mobile : 9822094741

*Ref. No. :*

*Date :*

## Internship Certificate

**Date: - 04/06/2022**

**From,**

Raj Polyfabrics pvt. Ltd.

Jejuri-412303.

31 may 2022.

**To,**

Sagar Khomane.

Jejuri.

**Sub:** Regarding your Internship in our company electrical maintenance Department.

Dear Sagar,

We would like to confirm that your application for Internship for the position of maintenance Executive in Electrical Department has been accepted. Here the terms of Internship while working with the company.

1. Duration of Internship will be from 15 April 2022 to 18 May 2022.
2. From time to time your Performance will be evaluated and based on the incentives will be decided.
3. During Internship you are expected to abide code of conduct prescribed by the company of all employees.

You're requested to submit your acceptance to the terms mentioned above as confirmation of your Internship.

Sincerely

For, Raj Polyfabrics Pvt. Ltd.





**DEPARTMENT OF CIVIL ENGINEERING**

Date:-10/04/2022

**NOTICE**

We are organizing an Industrial Visit for Final year students of Civil Engineering department at Gunjawai Earthen Dam, Gunjawani, Tal-Bhor, Dits-Pune on 12<sup>th</sup> April 2022, Tuesday.

There will be no classes for those students who will attend the visit on that day. Students are required to be in formal and carry their Identity card.

Following faculty members will accompany the students on Industrial visit:

1. Dr. S. S. Sayyed
2. Prof. S. P. Salunkhe

Prof. S. P. Salunkhe

**Subject Coordinator**

Dr. S. S. Sayyed

**HOD**



Rajgad Dnyanpeeth's  
**Shri Chhatrapati Shivajiraje College of Engineering**

Approved by AICTE, New Delhi, Recognized by Govt. of Maharashtra and Affiliated to Savitribai Phule  
Pune University, Pune (ID. PU/PN/Engg./376/2009), DTE CODE: EN6324, AISHE CODE : C-41588



Anantrao Thopte  
Founder President, Ex. Edu. Minister

Sangram Thopte  
M.L.A, Executive President

Dr. Bhagyashri Patil  
Hon. Secretary

Dr. S. B. Patil  
Principal

RD/SCSCOE/CIVIL/VISIT/2021-22/ 310

Date: 28/03/2022

To,  
The Executive Engineer,  
Gunjawani Dam,  
Near to Velhe,  
Pune, Maharashtra.

Subject: - Regarding permission to Gunjawani Dam.

Respected Sir,

Our Rajgad Dnyanpeeth's, Shri Chhatrapati Shivajiraje College of Engineering, Dhangawadi (Bhor) is affiliated to Savitribai Phule Pune University. As per the curriculum of Savitribai Phule Pune University for Final year students of Civil Engineering, we are planning an academic site visit at your institute under the Dams & Hydraulic Structure and Hydropower Engineering subjects.

This visit will enhance the skill of students to encourage the creative thinking process to help them to get confidence about the actual field work. Details about number of students & tentative dates are as follows,

- **Name of Faculty:** Asst. Prof. Shital. P. Salunkhe  
(Contact No-9860171442, Mail id-shitalpsalunkhe@gmail.com)
- **No of Students:** 61
- **No of Faculty members:** 02
- **Tentative Date:** 12-04-2022, Tuesday

Kindly do the needful.

Thanking you.

  
Dr. S. S. Sayyed  
HOD



  
Prof. Dr. S. B. Patil

Shri Chhatrapati Shivajiraje College of Engineering  
Dhangawadi, Pune-412265



महाराष्ट्र शासन

जलसंग्रह विभाग

कार्यकारी अभियंता, निरा देवघर प्रकल्प विभाग,

सांगवी (भाटघर), ता. भोर, जि. पुणे ४१२२०६

दूरध्वनी क्र. ०२११३ २०२०२० E-mail ID: niradeoghra@gmail.com



जा.क्र.निदेप्रवि घशा-४/१२५०/सन २०२२

दि.नांक :- ३२/०३/२०२२

प्रति,

प्राचार्य,

श्री. छत्रपती शिवाजीराजे कॉलेज ऑफ इंजिनीअरींग

धांगवाडी, ता. भोर, जि. पुणे

**विषय:-** Permission for educational visit at Gunjawani Dam.

**संदर्भ :-** आपले महाविद्यालयाचा दि. २८/०३/२०२२ रोजीचा प्राप्त ई-पत्र.

उपरोक्त विषयाबाबतचे आपले संदर्भिय पत्र या कार्यालयास प्राप्त झालेले आढ. आपल्या विनंतीस अनुमतेन खालील अटीच्या अधीन राहून आपल्या महाविद्यालयातील विद्यार्थ्यांना गुंजवणी धरण दिनांक २२/०४/२०२२ रोजी शैक्षणिक भेट देण्यास परवानगी देण्यात येत आहे.

- सद्यस्थितीत गुंजवणी धरणाचे काम पूर्ण झाले असून धरणावर असणाऱ्या शासकीय मान्यमनचे व कंत्राटदाराच्या कोणत्याही साहित्याचे नुकसान होणार नाही. याबाबत दक्षता घेण्यात यावी.
- सद्यस्थितीत निरा देवघर/ गुंजवणी धरणाच्या सांडव्याचे काम पूर्ण झाले असून धरणात पूर्ण क्षमतेन पाणीसाठा निर्माण झालेल्या असल्यामुळे धरणावरील सर्व कामे सुरक्षित अंतरावरून पाहणेची दक्षता घ्यावी.
- धरणाचे काम पहाताना विद्यार्थ्यांनी शिस्तीचे पालन करणे आवश्यक असून कोणताही अपघात होणार नाही याबाबत दक्षता घेण्यात यावी.
- धरणाच्या उध्वंवाजूस पाणीसाठा असल्याने विद्यार्थ्यांना पाण्यात प्रवेश करून देवू नये.
- धरणावरील रस्ते हे उंचसखल असल्याने विद्यार्थ्यांनी स्वतःच्या सुरक्षिततेची काळजी घेणे आवश्यक आहे.
- विद्यार्थ्यांच्या सुरक्षिततेची तसेच महाविद्यालयाच्या मालमत्तेची जबाबदारी सर्वस्वी महाविद्यालयाचीच असून त्यास हे कार्यालय जबाबदार राहणार नाही.
- शासन आदेशान्वये कोवीड-१९च्या अंतर्गत केलेल्या मार्गदर्शक सुचनांचे पालन करावे.

गुंजवणी धरण भेट देण्याअगोदर श्री. एन.टी.पोवार, स्था.अ. सहाय्यक, गुंजवणी उपविभाग, क्र.१ धानेप, ता. वेल्ले, जि. पुणे(भ्रमन दूरध्वनी- ९०६७४२५८८०) यांचेशी संपर्क साधावा.

स्थळ प्रत

(दि. म. डुबल)

कार्यकारी अभियंता

निरा देवघर प्रकल्प विभाग

सांगवी (भाटघर), ता. भोर, जि. पुणे

प्रत :-सहाय्यक अभियंता श्रेणी-१, गुंजवणी उपविभाग क्र. १ धानेप, जि. पुणे यांना माहितीसाठी व पुढील कार्यवाहीसाठी रवाना



Rajgad Dnyanpeeth's

**SHRI CHHATRAPATI SHIVAJIRAJE COLLEGE OF ENGINEERING**

Gat No. 237, Pune Bangalore Highway, Dhangawadi, Tal. Bhor, Dist- Pune (Maharashtra)

Dept.: Civil Engineering

Academic Year: 2021-22

Date: - 13/04/2022

SITE VISIT REPORT

- 1) **Class:** B.F Civil
- 2) **Subject:** Dams and Hydraulic Structure
- 3) **Name of Site:** Gunjawani Earthen Dam, Gunjawani, Taluka-Velhe, Dist-Pune
- 4) **Date & Time:** Tuesday, 12.04.2022 & 11.00 am To 2.30 pm
- 5) **Present Students:** 50/02
- 6) **Contact Person with Designation & Phone No.:** Mr. Namdev Powar, Jr. Engineer, -  
9067425880.
- 7) **Name of Faculty:** Prof. S. P. Salunkhe & Dr. S. S. Sayyed

As a part of academic curriculum, we visited the above site. We observed & studied the following things.

Content of studies:

- i. Study of Concept of earthen dam, components of earthen dam and its design
- ii. Study of spillway design
- iii. Study of Dam project details

The basic need of a project to provide a water for a scarcity area and also developed an electricity. Also some provisions make for an a irrigation, the dam constructed in a such area there is a high rainfall having intensity more than 2000mm accepted so it's helpful to save & store the water. The overall significance of project are given for provide a water for agriculture. In a summer the people are face a problem of scarcity and the agriculture are the main source of our country so the dam is constructed according to this significance to provide an a relief for a people in velhe district.

- Type- earth fill dam
- Impounds- Kanand River
- Length- 1730m
- Height- 52.82m
- Width-N/A
- Volume content-6871 cu.km
- Gross storage capacity- 104,480 cu.km





**Photos:-**



**Photo . Needle and Flat pitching & Drainage System**



**Photo :Site photo**





Photo :Ogee Spillway at Gunjawani dam





Photo :Er. Powar Sir explain all detail of dam

  
Prof. S. P. Salunkhe  
Faculty In-charge



  
Dr. S. S. Sayyed  
Head of Department  
Dept. of Civil Engineering  
Shri Chhatrapati Shivaji Maharaj College of Engineering  
Warananagar, Pune-412200



Anantrao Thopte

Founder President, Ex. Edu. Minister

Sangram Thopte

MLA, Executive President

Dr. Bhagyashri Patil

Hon. Secretary

Dr. S. B. Patil

Principal

RD/SCSCOE/CIVIL/VISIT/2021-22/323

Date: - 12/04/2022

To,

Er. D. M. Dubal,

Executive Engineer,

Nira Deodhar Project Divisional,

Sangavi (bhtaghar), Tal-Bhor

Dist-Pune-.

**Subject:-Letter of Gratitude.****Your Ref. No.:-NDPV.Est-4/1250/2022, Dated-31/03/2022**

Respected sir,

It give us immense pleasure in thanking you for allowing educational visit at Gunjawani dam dated on 12<sup>th</sup> April 2022.

It was a great learning experience for our students, detailed briefing given by staff is worth appreciation.

Thank you once again for your support and I hope that we will continue to receive your cooperation future.

Thanking You

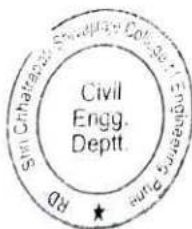

Yours faithfully

Dr. S. S. Sayyed

Head of Department

Dept. of Civil Engineering  
Shri Chh. Shivajiraje College of Engg  
Bhangwad, Pune-412206



Rajgad Dnyanpeeth's

**SHRI CHHATRAPATI SHIVAJIRAJE COLLEGE OF ENGINEERING**  
S. No. 237, Satara-Pune, NH-4, Dhangawadi, Tal: Bhor, Dist: Pune -412205 (MS), India.

Website: [www.rajgad.edu.in](http://www.rajgad.edu.in), Email Id: [sccscoe@gmail.com](mailto:sccscoe@gmail.com)

**DEPARTMENT OF CIVIL ENGINEERING**

A.Y-2021-22

Date: - 12/04/2022

**B.E Civil-List of students Enrolled for Site visit-Gunjawani Earthen Dam**

| Sr. No. | Roll No.  | Name of Student             | Sign        |
|---------|-----------|-----------------------------|-------------|
| 1       | BCI19D001 | Bandgar Priya Abaso         | PA. Bandgar |
| 2       | BCI19D002 | Barge Rutuja Nandkumar      | Rutuja      |
| 3       | BCI18D003 | Belvankar Swapnil Sanjay    | AB          |
| 4       | BCI19D004 | Bhilare Akshay Shankar      | AB          |
| 5       | BCI19D005 | Bhosale Rushikesh Kamalakar | Rushikesh   |
| 6       | BCI19D006 | Bobade Shubham Mohan        | Shubham     |
| 7       | BCI19D007 | Chavan Kunal Balasaheb      | Kunal       |
| 8       | BCI18D008 | Chavan Shubham Devram       | chavan      |
| 9       | BCI19D009 | Chavan Shubham Shivaji      | Shubham     |
| 10      | BCI19D010 | Chavare Rushikesh Baban     | Rushikesh   |
| 11      | BCI19D011 | Deshmukh Harshad Anil       | Harshad     |
| 12      | BCI19D012 | Eratkar Satyam Arun         | AB          |
| 13      | BCI16D013 | Gujalwad Ajay Nivrutti      | AB          |
| 14      | BCI19D014 | Gujar Mrunal Shekhar        | Mrunal      |
| 15      | BCI19D015 | Hiremath Pavankumar S.      | Pavankumar  |
| 16      | BCI19D016 | Ingavale Akshay Dattatray   | Ingavale    |
| 17      | BCI19D017 | Jagtap Vinay Chandrakant    | Vinay       |
| 18      | BCI19D018 | Kadam Shridhar Kantilal     | Shridhar    |
| 19      | BCI19D019 | Khambe Pruthviraj Shivaji   | AB          |
| 20      | BCI18D020 | Khopade Nikhil Atmaram      | Nikhil      |
| 21      | BCI19D021 | Kokare Yogita Rajendra      | Yogita      |
| 22      | BCI19D022 | Korade Omkar Tanaji         | Omkar       |
| 23      | BCI15D023 | Kulkarni Rohit Ramakantrao  | Rohit       |
| 24      | BCI19D024 | Kumbharkar Ritesh Vijay     | AB          |
| 25      | BCI19D025 | Kunjir Abhijit Kisan        | Abhijit     |
| 26      | BCI18F026 | Kunjir Abhishek Vikas       | Abhishek    |
| 27      | BCI19D027 | Kurale Vijaya Shrirang      | Vijaya      |

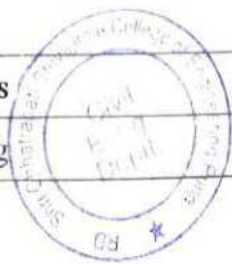

|    |           |                            |                    |
|----|-----------|----------------------------|--------------------|
| 29 | BCI19D029 | Malusare Bhagyashri Vikas  | <i>Malusare</i>    |
| 30 | BCI17F030 | Mane Rutuja Rajendra       | <i>Mane</i>        |
| 31 | BCI19D031 | Misal Prajakta Sharad      | <i>Misal</i>       |
| 32 | BCI19D032 | Mohite Payal Suresh        | <i>Mohite</i>      |
| 33 | BCI18F033 | More Vaishnavi Bhanudas    | <i>More</i>        |
| 34 | BCI19D034 | Pardeshi Swapnil Rajendra  | <i>Pardeshi</i>    |
| 35 | BCI19D035 | Patil Pruthviraj Pandurang | <i>Patil</i>       |
| 36 | BCI19D036 | Patil Sudarshan Dnyandev   | <i>Patil</i>       |
| 37 | BCI17F037 | Patil Sushant Sanjay       | <i>Patil</i>       |
| 38 | BCI17F038 | Patil Utkarsh Balaso       | <i>Patil</i>       |
| 39 | BCI19D039 | Pawale Rahul Keshav        | <i>AB</i>          |
| 40 | BCI16D040 | Pawar Pravin Prakash       | <i>AB TSGT</i>     |
| 41 | BCI18F041 | Pawar Shubham Anil         | <i>Shubham</i>     |
| 42 | BCI17F042 | Phalke Aniket Anandrao     | <i>Phalke</i>      |
| 43 | BCI16F043 | Phule Saurabh Balasaheb    | <i>Phule</i>       |
| 44 | BCI19D044 | Rajebhosale Rushikesh V.   | <i>Rajebhosale</i> |
| 45 | BCI19D045 | Rane Prajwal Gangaram      | <i>AB</i>          |
| 46 | BCI19D046 | Sable Digvijay Rohidas     | <i>Sable</i>       |
| 47 | BCI19D047 | Sarkate Prajakta Balish    | <i>Sarkate</i>     |
| 48 | BCI18F048 | Shedge Prajakta Hiralal    | <i>Shedge</i>      |
| 49 | BCI17F049 | Shinde Abhishek Sunil      | <i>Shinde</i>      |
| 50 | BCI19D050 | Shinde Sandeep Krishna     | <i>AB</i>          |
| 51 | BCI18F051 | Sonawane Prajakta Sandesh  | <i>Sonawane</i>    |
| 52 | BCI19D052 | Sukale Vishal Bhaun        | <i>Sukale</i>      |
| 53 | BCI19D053 | Sutar Vishal Dinkar        | <i>Sutar</i>       |
| 54 | BCI19D054 | Thopate Pritesh Namdev     | <i>Thopate</i>     |
| 55 | BCI17F055 | Valkunde Karan Rajendra    | <i>Valkunde</i>    |
| 56 | BCI17F056 | Valkunde Vishal Jaywant    | <i>Vishal</i>      |
| 57 | BCI19D057 | Wankhede Priti Vishwambar  | <i>AB</i>          |
| 58 | BCI19D058 | Yadav Sandesh Sharad       | <i>S.S. Yadav</i>  |
| 59 | BCI19D059 | Zagade Rohit Tukaram       | <i>Zagade</i>      |
| 60 | BCI16D060 | Shedge Nikhil Sushil       | <i>Shedge</i>      |
| 61 | BCI15D061 | Chavan Chaitanya Subhash   | <i>AB</i>          |

Present Student: 50

Subject Teacher

*S.P. Salunkhe*

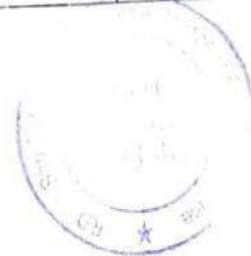

Rajgad Dnyanpeth's  
**Shri Chhatrapati Shivajiraje College of Engineering**

S. No. 237, Satara-Pune, NH-4, Dhangawadi, Tal: Bhore, Dist: Pune

REF: - RD/SCSCOE/CIVIL/ 2021-22/

Date: - 08/04/2022

To,  
The Estate Manager,  
RDTC, SCSCOE,  
Dhangawadi

**Subject: -** About requirement of bus facility for academic visit.

Respected Sir,

As per Curriculum of Savitribai Phule University of Pune, we have technical visit for B.E. Civil Engineering Students regarding the subject. We have decided to visit **Gunjavani dam, Taluka- Bhore**. In this context we need bus facility on 12<sup>th</sup> April 2022 at 10.00 am from our College Campus.

Kindly do the needful

Thanking You.

Yours Faithfully

  
Subject Teacher



  
H. O. D.  
(Dept. Of Civil Engineering)

Head of Department  
Dept. of Civil Engineering  
Shri Chhatrapati Shivajiraje College of Engg.  
Dhangawadi, Pune-412206

**17**

Rajgad Dnyanpeeth's  
**SHRI CHHATRAPATI SHIVAJIRAJE COLLEGE OF ENGINEERING**  
S. No. 237, Satara-Pune, NH-4, Dhangawadi, Tal: Bhor, Dist. Pune -412205 (MS), India  
Website: [www.rajgad.edu.in](http://www.rajgad.edu.in), Email Id: [scscoe@gmail.com](mailto:scscoe@gmail.com)

**DEPARTMENT OF CIVIL ENGINEERING**

Date:-10/04/2022

**NOTICE**

We are organizing an Industrial Visit for Final year students of Civil Engineering department at Gunjawai Earthen Dam –Hydropower plant (Ashoka Sthapatya Pvt. Ltd), Gunjawani, Tal-Bhor, and Dist.-Pune on 12<sup>th</sup> April 2022, Tuesday.

There will be no classes for those students who will attend the visit on that day. Students are required to be in formal and carry their Identity card.

Following faculty members will accompany the students on Industrial visit:

1. Dr. S. S. Sayyed
2. Prof. S. P. Salunkhe

Prof. S. S. Sayyed

**Subject Coordinator**

Dr. S. S. Sayyed

**Head of Department**  
**HOD**Dept. of Civil Engineering  
Shri Chhatrapati Shivaji Rajgad College of Engineering  
Dhangawadi, Pune-412205





Rajgad Dnyanpeeth's

**SHRI CHHATRAPATI SHIVAJIRAJE COLLEGE OF ENGINEERING**

Gat No. 237, Pune Bangalore Highway, Dhangawadi, Tal - Bhor, Dist- Pune (Maharashtra)

Dept.: Civil Engineering

Academic Year: 2021-22

**SITE VISIT REPORT**

Date: - 13/04/2022

- 1) **Class:** B.E Civil
- 2) **Subject:** Hydropower Engineering
- 3) **Name of Site:** Gunjawani Earthen Dam,-Hydropower plant (Ashoka Sthapatya Pvt.Ltd )  
,Taluka-Velhe, Dist-Pune
- 4) **Date & Time:** Tuesday, 12.04.2022 & 11.00 am To 2.30 pm
- 5) **Present Students:**50/02
- 6) **Contact Person with Designation & Phone No.:** Mr. Namdev Powar, Jr. Engineer, -  
9067425880.
- 7) **Name of Faculty:** Dr. S. S. Sayyed & Prof. S. P. Salunkhe

As a part of academic curriculum, we visited the above site. We observed & studied the following things.

**Content of studies:**

To produce hydroelectricity, three things must be present; moving water, a turbine, and a generator. Hydropower stations are designed to harness the kinetic energy from moving water. Ideally, they are factories that convert the energy of falling water into the flow of electrons, commonly known as electricity. In most scenarios, a dam is constructed across a river to elevate the water level and offer the fall needed to develop a driving force. The falling water is then channeled to a turbine wheel at a lower level. The flowing water turns a turbine wheel that is connected to a generator. The generator has a rotor, which is turned by the turbine. The turning of the generator rotor produces electricity. There are 7 important components of hydroelectric power plant as below.

- 1) Impeller
- 2) Shaft
- 3) Runner
- 4) Casing
- 5) The penstock
- 6) Water turbine
- 7) Generator



Photos:-



Photo No.1- Pelton Turbine



Photo No.-2 Control Panel system



Photo No.3 Site Photo

*[Handwritten Signature]*

Dr. S. S. Sayyed  
Faculty In-charge

*[Handwritten Signature]*

Dr. S. S. Sayyed  
Head of Department  
Dept. of Civil Engineering  
Shri Chh. Shivrajrao Coll  
Dhanjswadi, Pune-422006



Rajgad Dnyanpeeth's  
**Shri Chhatrapati Shivajiraje College of Engineering**  
S. No. 237, Satara-Pune,NH-4, Dhangawadi, Tal: Bhor, Dist: Pune

REF: - RD/SCSCOE/CIVIL/ 2021-22/

Date: - 08/04/2022

To,  
The Estate Manager,  
RDTC, SCSCOE,  
Dhangawadi

**Subject:** - About requirement of bus facility for academic visit.

Respected Sir,

As per Curriculum of Savitribai Phule University of Pune, we have technical visit for B.E. Civil Engineering Students regarding the subject. We have decided to visit **Gunjavani dam, Taluka- Bhor**. In this context we need bus facility on 12<sup>th</sup> April 2022 at 10.00 am from our College Campus.

Kindly do the needful

Thanking You.

Yours Faithfully

  
Subject Teacher



  
H. O. D.  
(Dept. Of Civil Engineering)

Head of Department  
Dept. of Civil Engineering  
Shri Chh. Shivajiraje College of Engg.  
Dhangawadi, Pune-412206



Rajgad Dnyanpeeth's

SHRI CHHATRAPATI SHIVAJIRAJE COLLEGE OF ENGINEERING  
S. No. 237, Satara-Pune, NH-4, Dhangawadi, Tal. Bhor, Dist. Pune 412205 (MS), India

Website www.rajgad.edu.in, Email Id scscoe@gmail.com

## DEPARTMENT OF CIVIL ENGINEERING

Date - 12/04/2022

A.Y.-2021-22

B.E Civil-List of students Enrolled for Site visit-Gunjawani EarthenDam Hydropower Plant

| Sr. No. | Roll No.  | Name of Student             | Sign       |
|---------|-----------|-----------------------------|------------|
| 1       | BC119D001 | Bandgar Priya Abaso         | PA Bandgar |
| 2       | BC119D002 | Barge Rutuja Nandkumar      | RB         |
| 3       | BC118D003 | Belvankar Swapnil Sanjay    | SB         |
| 4       | BC119D004 | Bhilare Akshay Shankar      | AB         |
| 5       | BC119D005 | Bhosale Rushikesh Kamalakar | RB         |
| 6       | BC119D006 | Bobade Shubham Mohan        | SB         |
| 7       | BC119D007 | Chavan Kunal Balasaheb      | CB         |
| 8       | BC118D008 | Chavan Shubham Devram       | SB         |
| 9       | BC119D009 | Chavan Shubham Shivaji      | SB         |
| 10      | BC119D010 | Chavare Rushikesh Baban     | CB         |
| 11      | BC119D011 | Deshmukh Harshad Anil       | AD         |
| 12      | BC119D012 | Eratkar Satyam Arun         | AE         |
| 13      | BC116D013 | Gujalwad Ajay Nivrutti      | AG         |
| 14      | BC119D014 | Gujar Mrunal Shekhar        | GS         |
| 15      | BC119D015 | Hiremath Pavankumar S.      | PH         |
| 16      | BC119D016 | Ingavale Akshay Dattatray   | IA         |
| 17      | BC119D017 | Jagtap Vinay Chandrakant    | JV         |
| 18      | BC119D018 | Kadam Shridhar Kantilal     | SK         |
| 19      | BC119D019 | Khambe Pruthviraj Shivaji   | PK         |
| 20      | BC118D020 | Khopade Nikhil Atmaram      | KN         |
| 21      | BC119D021 | Kokare Yogita Rajendra      | KY         |
| 22      | BC119D022 | Korade Omkar Tanaji         | KO         |
| 23      | BC115D023 | Kulkarni Rohit Ramakantrao  | KR         |
| 24      | BC119D024 | Kumbharkar Ritesh Vijay     | KV         |
| 25      | BC119D025 | Kunjir Abhijit Kisan        | AK         |
| 26      | BC118F026 | Kunjir Abhishek Vikas       | AV         |
| 27      | BC119D027 | Kurale Vijaya Shrirang      | KV         |



|    |           |                            |  |
|----|-----------|----------------------------|--|
| 28 | BC119D028 | Mali Aniket Ganaji         |  |
| 29 | BC119D029 | Malusare Bhagyashri Vikas  |  |
| 30 | BC117F030 | Mane Rutuja Rajendra       |  |
| 31 | BC119D031 | Misal Prajakta Sharad      |  |
| 32 | BC119D032 | Mohite Payal Suresh        |  |
| 33 | BC118F033 | More Vaishnavi Bhanudas    |  |
| 34 | BC119D034 | Pardeshi Swapnil Rajendra  |  |
| 35 | BC119D035 | Patil Pruthviraj Pandurang |  |
| 36 | BC119D036 | Patil Sudarshan Dnyandeo   |  |
| 37 | BC117F037 | Patil Sushant Sanjay       |  |
| 38 | BC117F038 | Patil Utkarsh Balaso       |  |
| 39 | BC119D039 | Pawale Rahul Keshav        |  |
| 40 | BC116D040 | Pawar Pravin Prakash       |  |
| 41 | BC118F041 | Pawar Shubham Anil         |  |
| 42 | BC117F042 | Phalke Aniket Anandiroo    |  |
| 43 | BC116F043 | Phule Saurabh Balasaheb    |  |
| 44 | BC119D044 | Rajebhosale Rushikesh V.   |  |
| 45 | BC119D045 | Rane Prajwal Gangaram      |  |
| 46 | BC119D046 | Sable Digvijay Rohidas     |  |
| 47 | BC119D047 | Sarkate Prajakta Ganish    |  |
| 48 | BC118F048 | Shedge Prajakta Hiralal    |  |
| 49 | BC117F049 | Shinde Abhishek Sunil      |  |
| 50 | BC119D050 | Shinde Sandeep Krishna     |  |
| 51 | BC118F051 | Sonawane Prajakta Sandesh  |  |
| 52 | BC119D052 | Sukale Vishal Bhaou        |  |
| 53 | BC119D053 | Sutar Vishal Dinkar        |  |
| 54 | BC119D054 | Thopate Pritesh Namdev     |  |
| 55 | BC117F055 | Valkunde Karan Rajendra    |  |
| 56 | BC117F056 | Valkunde Vishal Jaywant    |  |
| 57 | BC119D057 | Wankhede Priti Vishwambar  |  |
| 58 | BC119D058 | Yadav Sandesh Sharad       |  |
| 59 | BC119D059 | Zagade Rohit Tukaram       |  |
| 60 | BC116D060 | Shedge Nikhil Sushil       |  |
| 61 | BC115D061 | Chavan Chaitanya Subhash   |  |

Present Student: 50

Subject Teacher

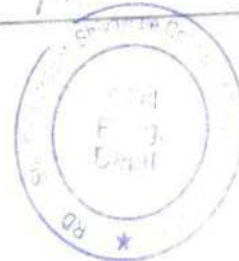

*S. S. Yadav*

*S. P. Salunke*



**Anant Rao Thopte**  
Founder President, Ex. Edu. Minister

**Sangram Thopte**  
M.I.A., Executive President

**Dr. Bhagyashri Patil**  
Hon. Secretary

**Dr. S. B. Patil**  
Principal

RD/SCSCOE/CIVIL/VISIT/2021-22/323

Date: - 12/04/2022

To,

Managing Director,

Ashoka Sthapatya Pvt. Ltd.,

Maharashtra.

**Subject:-Letter of Gratitude.**

Respected sir,

It gives us immense pleasure in thanking you for allowing an educational visit to Gunjawani Hydro Electric Project, Velhe dated on 12<sup>th</sup> April 2022.

It was a great learning experience for our students, a detailed briefing given by staff is worth appreciation.

Thank you once again for your support and I hope that we will continue to receive your cooperation future.

Thanking You

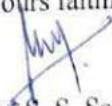

Yours faithfully

  
Dr. S. S. Sayyed

**Head of Department**  
Dept. of Civil Engineering  
Shri Chh. Shivajiraje College of Engg.  
Dhangawadi, Pune-412206

18



# Certificate of Internship

This is presented to

Pawar Swarali Ramchandra

In appreciation for your successful work as an intern at  
**DYNAMIC SOLUTION**

The internship was conducted at 8-April - 20 May

**DYNAMIC SOLUTION**  
PLACE:  
BANER PUNE



  
(AUTHORISED SIGNATORY)  
**TRUSHNA BHOLE**  
DIRECTOR



Rajgad Dnyanpeeth's

**SHRI CHHATRAPATI SHIVAJIRAJE COLLEGE OF ENGINEERING**

S. No. 237, Satara-Pune, NH-4, Dhangawadi, Tal: Bhor, Dist: Pune -412205 (MS), India.

Website: [www.rajgad.edu.in](http://www.rajgad.edu.in), Email Id: [scscoe@gmail.com](mailto:scscoe@gmail.com)

**DEPARTMENT OF MECHANICAL ENGINEERING**

**NOTICE**

Date: 03/04/2022

All Mechanical Engineering students are hereby informed that our Mechanical Engineering Department organized a visit to **Pune Alternate Fuel Conclave (AFC)**, an initiative of the Government of Maharashtra, is being organised by Maharashtra Industrial Development Corporation (MIDC) and Maharashtra Pollution Control Board (MPCB), in association with Maratha Chamber of Commerce, Industries and Agriculture (MCCIA) on **5<sup>th</sup> April 2022** at **Sinchan Nagar Ground, Agriculture College, Pune**. Attendance is mandatory to all students.



  
Prof. S. K. Pawar  
**Head of Department**

**Head of Department**  
Dept. of Mechanical Engineering  
Shri Chh. Shivajiraje College of Engg.  
Dhangawadi, Pune-412206





4/2/2022

To

The Principal,

SCSCOE, Bhor, Pune

Subject-Permission to visit Pune Alternate Fuel Exhibition.

Respected Sir,

To create awareness about alternative fuels which can be used to protect environment by reducing pollution, Govt. of Maharashtra arranged Alternate Fuel Exhibition in association with Maharashtra Industrial Development Corporation(MIDC), Maharashtra Pollution Control Board(MPCB) and Maratha Chamber of Commerce and Agriculture(MCCIA) at Sinchan Bhawan Ground, Agriculture college, Pune during 2<sup>nd</sup> April to 5<sup>th</sup> April 2022. Visit to exhibition is beneficial to Mechanical Engineering students to enhance their knowledge. Directorate of Technical Education also informed us to visit exhibition. Fourty five students along with 2 staff members are willing to visit exhibition tomorrow i.e. 5<sup>th</sup> April 2022. Please give us permission to visit exhibition with necessary arrangement of one bus from college to Shivajinagar, Pune.

Thanking you.

Yours Truly,

*[Signature]*

Head of Department

Dept. of Mechanical Engineering  
Shri Chh. Shivajiraje College of Engg.  
Dhangawadi, Pune-412206

Permitted  
*[Signature]*

*Estate Manager / Transport Incharge*

*Kindly do the needful*

*[Signature]*  
4/104/2022





Rajgad Dnyanpeeth's

**SHRI CHHATRAPATI SHIVAJIRAJE COLLEGE OF ENGINEERING**  
S. No. 237, Satara-Pune, NH-4, Dhangawadi, Tal: Bhor, Dist: Pune -412205 (MS), India.

Website: [www.rajgad.edu.in](http://www.rajgad.edu.in), Email Id: [scscoe@gmail.com](mailto:scscoe@gmail.com)

## **PUNE ALTERNATE FUEL CONCLAVE-2022 VISIT REPORT**

**Date:** 05/04/2022

**Time :** 11 AM to 6 PM

**Venue :** Sinchan Nagar Ground, Agriculture College, Pune

**Faculty Members:**

1. Prof. S. K. Pawar
2. Prof. M. B. Bankar

**About the Pune Alternate Fuel Conclave 2022-**

The Pune Alternate Fuel Conclave (AFC), an initiative of the Government of Maharashtra, is being organised by Maharashtra Industrial Development Corporation (MIDC) and Maharashtra Pollution Control Board (MPCB), in association with Maratha Chamber of Commerce, Industries and Agriculture (MCCIA) from 2nd to 5th April 2022, in Pune.

**The objectives of the Conclave include:**

- To attract investment in alternate fuels & clean mobility in Maharashtra by positioning the state as a domain leader
- To provide a platform for dialogue between key stakeholders on clean mobility technologies
- To create an awareness among the masses about clean mobility initiatives across the globe
- To help design and conceptualise a pathway for promoting clean mobility solutions

Pune AFC 2022 will host India's largest vehicle exhibition exclusively focused on alternate fuel technologies in Conclave. Two-wheelers, three-wheelers, cars, goods vehicles, and buses from leading manufacturers like Tata Motors, Piaggio, Skoda, Volkswagen, KPIT, etc. powered by electricity, hydrogen fuel, and biofuels on display for students in this conclave. Also, different Companies have launched new products on the auspicious occasion of Gudi Padwa. The exhibition is free for anyone to attend. Pune's Regional Transport Office (RTO) also present at the Exhibition to facilitate purchase and easy registration of new vehicles by the citizens. Pune



EV Cell is also present at the Exhibition to act as a knowledge hub for the citizens and to spread awareness about electric vehicles and various government policies.

An Pune AFC 2022 visit at Sinchan Nagar Ground, Agriculture College, Pune was done by the SCSCOE, third year 60 students on 5<sup>th</sup> April 2022. Such visits really added up to the little knowledge of the students and everyone wished for this to happen time and again to seek some exposure and motivation. Everyone is thankful to Prof. S. K. Pawar, HOD Mechanical Engineering for organizing this visit.



Group Photo of Pune AFC 2022 visit at Sinchan Nagar Ground, Agriculture College, Pune

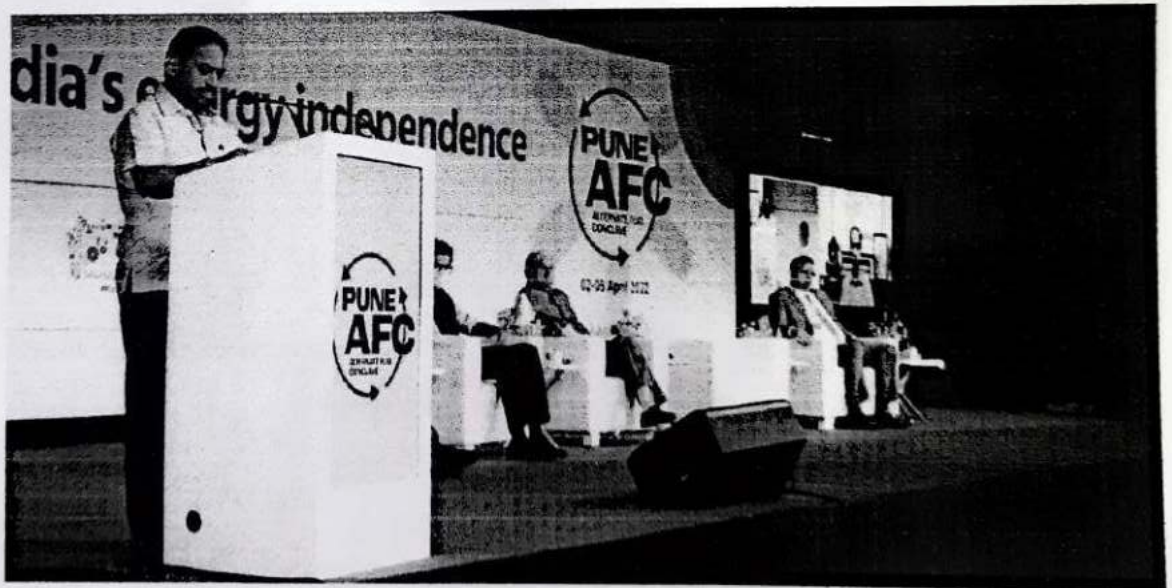

President of MCCIA addressing Pune AFC 2022





Photograph during Pune AFC 2022 visit

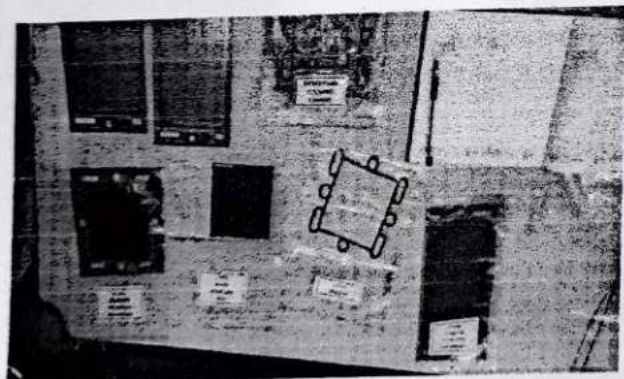

Photographs during Pune AFC 2022 visit

Prof. S. K. Pawar  
**HOD, Mechanical Engg.**  
**Head of Department**  
 Dept. of Mechanical Engineering  
 Shri Chh. Shivajiraje College of Engg.  
 Dhangawadi, Pune-412205



Prof. Dr. S. B. Patil  
**Principal**

Shri Chhatrapati Shivajiraje College of Engg.,  
 Dhangawadi, Pune-412206



| Sr. No. | Roll No.  | Name of Student              | Sign       |
|---------|-----------|------------------------------|------------|
| 1       | BME20D001 | ALGUDE SWAPNIL DILIP         | Swapnil    |
| 2       | BME20D002 | AWADE SHRIKANT SUNIL         | Absent     |
| 3       | BME20D003 | BABAR AJINKYA SUBHASH        | Subhash    |
| 4       | BME20D004 | BENDRE ABHISHEK GAJANAN      | Abhishek   |
| 5       | BME18F005 | BHALGHARE PANDURANG NARAYAN  | Pandurang  |
| 6       | BME20D006 | BHIVATE KARTIK PRABHAKAR     | Kartik     |
| 7       | BME20D007 | BHOSALE AKANKSHA VIJAY       | Akanksha   |
| 8       | BME20D008 | BHOSALE NILAM SANJAY         | Absent     |
| 9       | BME20D009 | BHOSALE SHAMBHURAJ DATTATRAY | Shambhuraj |
| 10      | BME20D010 | BHOSALE YASH SANTOSH         | Yash       |
| 11      | BME16D011 | BIRADAR AKASH DINKAR         | Akash      |
| 12      | BME20D012 | BIRADAR ANIKET GOVIND        | Aniket     |
| 13      | BME20D013 | BOBADE AVDHUT ANIL           | Avdhut     |
| 14      | BME20D014 | BORKAR PRAVIN DADASAHEB      | Pravin     |
| 15      | BME20D015 | CHAVAN DNYANRAJ PRAVIN       | Dnyanraj   |
| 16      | BME20D016 | CHAVAN OMKAR BALKRUSHNA      | Omkar      |
| 17      | BME20D017 | CHAVAN SAGAR RAMDAS          | Sagar      |
| 18      | BME20D018 | CHOUGULE PAVAN DHANANJAY     | Pavan      |
| 19      | BME19F019 | DABHOLKAR ATHARVA GURUPRASAD | Atharva    |
| 20      | BME18F020 | DEVKAR KEWAL YUVRAJ          | Kewal      |
| 21      | BME20D021 | DEVLEKAR SAURABH SANJAY      | Saurabh    |
| 22      | BME20D022 | DHAIGUDE SAGAR RAMESH        | Sagar      |
| 23      | BME19F023 | DHAME SHRINIVAS BALASO       | Absent     |
| 24      | BME20D024 | DHANAWADE SALONI KISAN       | Saloni     |
| 25      | BME20D025 | GADE SOMANATH ASHRUBA        | Somanath   |
| 26      | BME20D026 | GAIKWAD SOURABH ANNASO       | Sourabh    |
| 27      | BME20D027 | GHADGE ATISH SAYAJI          | Atish      |
| 28      | BME20D028 | GUJAR CHIRAG RAJESH          | Chirag     |
| 29      | BME20D029 | HARIHAR KIRAN DEEPAK         | Kiran      |
| 30      | BME20D030 | INGULKAR RUSHIKESH PRAVIN    | Absent     |
| 31      | BME18F031 | JADHAV ANIKET SANJAY         | Aniket     |
| 32      | BME20D032 | JADHAV KIRAN RAJARAM         | Absent     |
| 33      | BME18F033 | JADHAV KISHOR HIRALAL        | Kishor     |
| 34      | BME20D034 | JADHAV RAVIRAJ SHRIKANT      | Raviraj    |



| Sr. No. | Roll No.  | Name of Student              | Sign        |
|---------|-----------|------------------------------|-------------|
| 35      | BME20D035 | JAGTAP SHUBHAM ANIL          | Jyoti S. 11 |
| 36      | BME20D036 | JAGTAP SURAJ VASANT          | Suraj       |
| 37      | BME20D037 | KADAM ROHIT SHANKAR          | Rohit Kadam |
| 38      | BME20D038 | KADAM VAIBHAV VILAS          | Kadam       |
| 39      | BME19F039 | KADAM VAISHNAVI PRADIP       | Kadam       |
| 40      | BME20D040 | KALE ABHIJIT BALASAHEB       | Abhijit     |
| 41      | BME20D041 | KAMBLE NITIN SUGREEV         | Nitin       |
| 42      | BME17F042 | KAMBLE SHUBHAM SUDHIR        | Shubham     |
| 43      | BME20D043 | KAMBLE SIDDHARTHA RAOSO      | Siddhartha  |
| 44      | BME19F044 | KARANDE OMKAR SANTOSH        | Omkar       |
| 45      | BME20D045 | KARVE SAIRAJ RAMDAS          | Sairaj      |
| 46      | BME19F046 | KAZI AZAM RAJ                | Kazi A. R.  |
| 47      | BME19F047 | KHOT PRATHAMESH SANJAY       | Prathamesh  |
| 48      | BME19F048 | KINDRE ROHIT ANIL            | Rohit       |
| 49      | BME20D049 | KONDHALKAR SHUBHAM PRAKASH   | Shubham     |
| 50      | BME20D050 | KORDE MAHADEV ASARAM         | Korde       |
| 51      | BME20D051 | KUMBHAR NISHANT DESHRAJ      | Nishant     |
| 52      | BME18F052 | MAHANGARE ANIKET BHARAT      | Aniket      |
| 53      | BME20D053 | MANE SUHAS MOHAN             | Suhas       |
| 54      | BME20D054 | MOTE RAVIKIRAN MARUTI        | Absent      |
| 55      | BME20D055 | MUJAWAR ASHRAF SHABBIR       | Ashraf      |
| 56      | BME20D056 | MULE SUDHIR RAJESH           | Sudhir      |
| 57      | BME20D057 | NAIK SACHIN MOHAN            | Sachin      |
| 58      | BME20D058 | NALAWADE PRASAD PRAKASH      | Prasad      |
| 59      | BME20D059 | NALAWADE SHUBHAM CHANDRAKANT | Shubham     |
| 60      | BME20D060 | NIGADE TEJAS SHIVAJI         | Tejas       |
| 61      | BME20D061 | NIKALAJE SURAJ RAJENDRA      | Suraj       |
| 62      | BME19F062 | NIKAM OMKAR SUNIL            | O.S. Nikam  |
| 63      | BME20D063 | NIMBALKAR AKASH KHAJEPPA     | Absent      |
| 64      | BME20D064 | PANDIT SANKET VINOD          | Sanket      |
| 65      | BME18F065 | PARTE PRATIK ATMARAM         | Pratik      |
| 66      | BME20D066 | PATIL TUSHAR SITARAM         | Tushar      |
| 67      | BME18F067 | PAWAR ANIKET RAMAKANT        | Aniket      |
| 68      | BME19F068 | PEDNEKAR OMKAR CHANDRAKANT   | Omkar       |
| 69      | BME20D069 | PISAL AKASH KIRAN            | Absent      |
| 70      | BME20D070 | POKALE MANISH DATTATRAY      | Absent      |

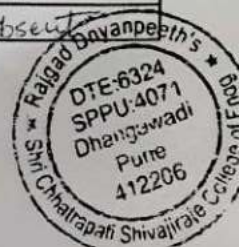

# CERTIFICATE

OF APPRECIATION

this certificate is proudly presented to:

*Kshirsagar Vaibhav Mohan*

in recognition of completing her internship at Prabhupada World in the field of Flutter App Development from 5 April 2022 to 5 May 2022



*Mayank Goel*

MAYANK GOEL



INTERNSHIP COORDINATOR, PRABHUPADA WORLD



**PRABHUPADA  
WORLD**

Delivering the essence of Immortal Vedic wisdom



# CERTIFICATE

## OF APPRECIATION

this certificate is proudly presented to:

*Aditi Jagdish Kachhi*

in recognition of completing her internship at Prabhupada World in the field of Flutter App Development from 5 April 2022 to 5 May 2022



*Mayank Goel*

**MAYANK GOEL**

INTERNSHIP COORDINATOR, PRABHUPADA WORLD

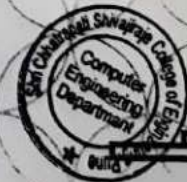





RajgadDnyanpeeth's  
**SHRI CHHATRAPATI SHIVAJIRAJE COLLEGE OF ENGINEERING**  
 S. No. 237, Satara-Pune, NH-4, Dhangawadi, Tal: Bhor, Dist: Pune -412205 (MS), India.  
 Website: www.raigad.edu.in, Email Id: scscoe@gmail.com

**DEPARTMENT OF CIVIL ENGINEERING**

Date:-01/04/2022

**NOTICE**

We are organizing an Industrial Visit for Final year students of Civil Engineering department at Khambatki Tunnel, Tal-Khandala, Dist-Satara on 04<sup>th</sup> April 2022, Monday.

There will be no classes for those students who will attend the visit on that day. Students are required to be in formal and carry their Identity card.

Following faculty members will accompany the students on Industrial visit:

1. Dr. S. S. Sayyed
2. Prof. S. S. Jadhav

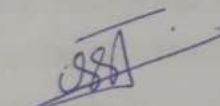
  
 Prof. S. S. Jadhav

**Subject Coordinator**

  
 Dr. S. S. Sayyed  
**Head of Department**  
 Dept. of Civil Engineering  
**HOD**  
 Shri Chh. Shivajiraje College of Engg.  
 Dhangawadi, Pune-412206





Rajgad Dnyanpeeth's

# Shri Chhatrapati Shivajiraje College of Engineering



Approved by AICTE, New Delhi, Recognized by Govt. of Maharashtra and Affiliated to Savitribai Phule Pune University, Pune (ID. PU/PN/Engg./376/2009), DTE CODE: EN6324, AISHE CODE : C-41588

Anantrao Thopte  
Founder President, Ex. Edu. Minister

Sangram Thopte  
MLA, Executive President

Dr. Bhagyashri Patil  
Hon. Secretary

Dr. S. B. Patil  
Principal

RD/SCSCOE/CIVIL/VISIT/2021-22/311

Date: 28/03/2022

To,  
The Project Director,  
NHAI PIU, Pune  
Warje, 411058  
Maharashtra.

Subject: Permission to Visit Ongoing Construction Site of Twin Tunnels at Khambatki Ghat.

Respected Sir,

Our Rajgad Dnyanpeeth's, Shri Chhatrapati Shivajiraje College of Engineering, Dhangawadi (Bhor) is affiliated to Savitribai Phule Pune University. Throughout the academic year we are arranging various co-curricular and extra-curricular activities for the students and staff to motivate the young talents in Engineering and Technology who are pillar of future India. It is our sincere request to you please permit us to visit ongoing construction site of twin tunnels at Khambatki Ghat Section.

This visit will enhance the skill of students to encourage the creative thinking process to help them to get confidence about the actual field work. On the behalf of Shri Chhatrapati Shivajiraje College of Engg. Dhangawadi, I assure that our students will maintain discipline and follow all safety protocols and rules regulations during the visit.

Details about number of students & tentative dates are as follows,

- Name of Faculty: Asst. Prof. Shital. P. Salunkhe  
(Contact No-9860171442, Mail id-shitalpsalunkhe@gmail.com)
- No of Students: 61
- No of Faculty members: 05
- Tentative Date: 04-04-2022, Friday

Kindly do the needful.

Thanking you.

  
Dr. S. S. Sayyed  
Head of Department  
Dept. of Civil Engineering  
Shri Chh. Shivajiraje College of Engg.  
Dhangawadi, Pune-412206

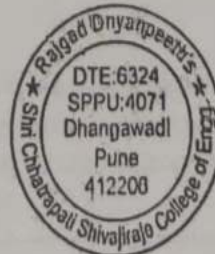

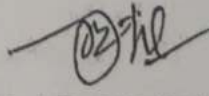
  
Prof. Dr. S. B. Patil  
Principal  
Rajgad Dnyanpeeth's  
Shri Chhatrapati Shivajiraje College of Engg.  
Dhangawadi, Pune-412206



# भारतीय राष्ट्रीय राजमार्ग प्राधिकरण

(सड़क परिवहन और राजमार्ग मंत्रालय, भारत सरकार)

## National Highways Authority of India

(Ministry of Road Transport & Highways, Govt. of India.)  
Project implementation Unit, Pune.



स.नं. १३४/१, बायफ भवन कॅम्पस, डॉ. मणीभाई देसाई नगर, वारजे, पुणे - ४११ ०५८. महाराष्ट्र राज्य.  
S.No. 134/1, BAIF Bhawan Campus, Dr. Manibhai Desai Nagar, Warje Pune - 411 058. Maharashtra State.

दूरभाष/Tel.: 020 29706884 / 85 / 81 Email: pune@nhai.org

NHAI/PIU/PUNE/New KT/2022/1102

29.03.2022

To,  
Prof. Dr. S. B. Patil,  
Principal,  
Rajgad Dnyanpeeth's  
Shri Chhatrapati Shivajiraje College of Engineer,  
Dhangawadi, Pune - 412 206.

RD'S SUSCOE

Inward No. 106

Date: 8/06/2022

Sub.: Construction of new six lane tunnel at Khambataki Ghat section of NH-4 and its approaches from Existing Km 771.730 to existing Km 782.000 in the state Maharashtra - Permission for technical site visit at Khambataki Tunnel Work - Reg.

Ref.:

1. Your office letter No. 311 dated 28.03.2022.

Sir,

1. Please refer your office letter regarding above mentioned subject.
2. It is to inform you that, necessary directions are given to Contractor & Authority Engineer of the Project regarding your site visit, scheduled on 04th April.
3. You are requested to follow all safety norms at site as directed by Contractor. Your safety is solely your responsibility. Wearing of helmet and safety jacket is compulsory at site. Neither NHAI nor Contractor will be responsible for any mishappening at site.
4. Based on above conditions, permission is granted for technical site visit.
5. This letter is issued with the approval of Project Director.

Thanking you,

Yours sincerely,

(Abhijeet Aute)  
Dy. Manager (Tech)

Encl.: As above

Copy to:

1. M/s Gayatri Projects Ltd - Crescent EPC Projects & Technical Services Pvt. Ltd. (JV) - provide all necessary information & guidance as desired by visitors.
2. M/s. Segmental Consulting and infrastructure Advisory Pvt.Ltd.in JV with SOWIL Ltd - for information and necessary action.
3. Master file.

प्रधान कार्यालय : जी 5 एवं 6, सेक्टर 10, द्वारका, नई दिल्ली - 110 075 दूरभाष: 2507 4100 / 2507 4200 फैक्स: 011 - 2509 2507 / 2509 3514

वेबसाईट: http://www.nhai.org

Head Office: No. G5 & 6, Sector 10, Dwarka, New Delhi - 110 075. Tel. No.: 011 - 2507 4100 / 2507 4200 Fax No. 011 - 2509 2507 / 2509 3514

Web Site : http://www.nhai.org

Rajgad Dnyanpeeth's  
RAJGAD DNYANPEETH TECHNICAL CAMPUS  
**Shri Chhatrapati Shivajiraje College of Engineering**  
(S. No. 237, Dhangawadi, Tal- Bhore, Dist- Pune - 412206 )

REF: - RD/SCSCOE/CIVIL/ 2021-22/

Date: - 31/03/2022

To,  
The Estate Manager,  
RDTC, SCSCOE,  
Dhangawadi

**Subject: -** About requirement of bus facility for academic visit.

Respected Sir,

As per Curriculum of Savitribai Phule University of Pune, we have technical visit for S.E/T.E./B.E. Civil Engineering Students regarding the Transportation Engineering subject. We have decided to visit ongoing construction site of **Khambatki Tunnel, Khandala, Taluka-Khandala**. In this context we need bus facility on **4<sup>th</sup> April 2022 at 10.00 am** from our College Campus.

Kindly do the needful

Thanking You.

Yours Faithfully

  
Subject Teacher



  
H. O. D.  
(Dept. Of Civil Engineering)  
Head of Department  
Dept. of Civil Engineering  
Shri Chh. Shivajiraje College of E  
Dhangawadi, Pune-412206



Rajgad Dnyanpeeth's

**SHRI CHHATRAPATI SHIVAJIRAJE COLLEGE OF ENGINEERING**  
Gat No. 237, Pune Bangalore Highway, Dhangawadi, Tal – Bhor, Dist- Pune (Maharashtra)

Dept.: Civil Engineering

Academic Year: 2021-22

SITE VISIT REPORT

Date: - 05/04/2022

- 1) **Class:** B.E Civil
  - 2) **Subject:** Construction Management
  - 3) **Name of Site:** Khambatki Tunnel, Velu ,Taluka-Khandala, Dist-Satara
  - 4) **Date & Time:** Monday, 01.04.2022 & 11.00 am To 2.30 pm
  - 5) **Present Students:**50/02
  - 6) **Contact Person with Designation:** Mr. Abhijeet Aute (Dy. Manager (Tech))
  - 7) **Name of Faculty:** Prof. S. S. Jadhav & Dr. S. S.Sayyed
- As a part of academic curriculum, we visited the above site. We observed & studied the following things.

Content of studies:

- i. Study of Concept of Tunnel , components of Tunnel and its design
- ii. Study of Equipment & method used for tunnel construction
- iii. Study of Tunnel project details

The basic need of a project to provide ease out traffic congestion especially in Ghat Section & Old tunnel. And also reduce travel time. The main objective of the construction of tunnel and widening of the existing 4 laning road into six lanes is to improve the performance of the national road transport network. Apart from connectivity considerations, the corridor has been perceived to be important from the perspective of development in Satara district in general and Khambatki region in particular.

- Type- Transportation Tunnel
- Lane- 06
- Impounds- Khambataki Ghat Section of NH-4
- Length- 1148 m
- Diameter- 18m

Photos:-



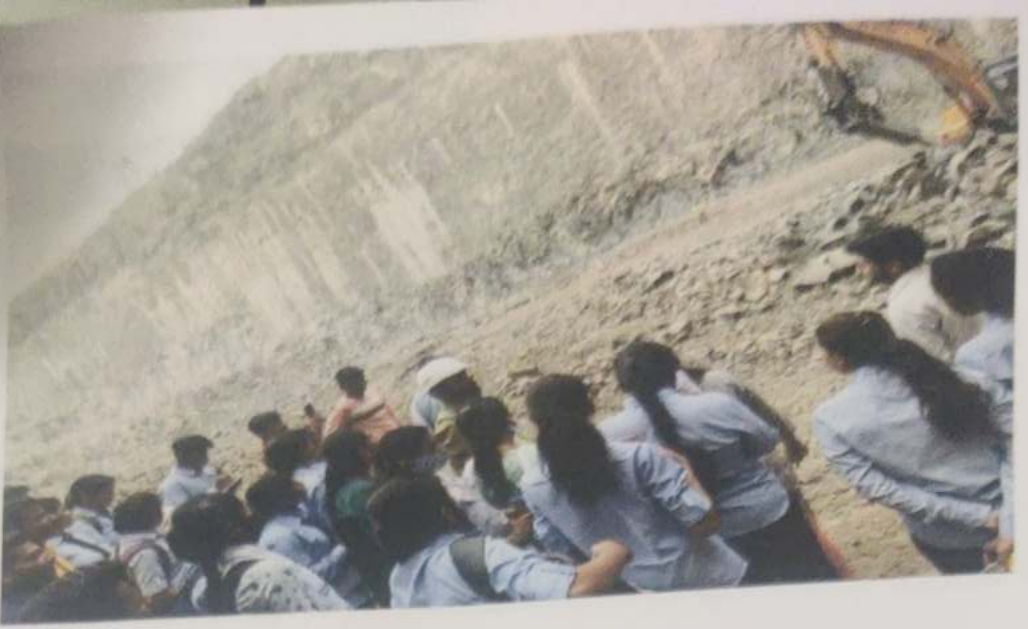

Photo . Geological Information



Photo :Site photo





Photo : Precaste Girder Member



Photo : Tunnel Construction Equipment





**Photo : With Project Team Member**

**Prof. S. S. Jadhav**  
**Faculty In-charge**

**Dr. S. S. Sayyed**  
**Head of Department**  
Dept. of Civil Engineering  
Shri Chh. Shivajiraje College of Engg.  
Dhangawadi, Pune-412206





RajgadDnyanpeeth's

**SHRI CHHATRAPATI SHIVAJIRAJE COLLEGE OF ENGINEERING**

S. No. 237, Satara-Pune, NH-4, Dhangawadi, Tal: Bhor, Dist: Pune -412205 (MS), India.  
Website: [www.rajgad.edu.in](http://www.rajgad.edu.in), Email Id: [sescoc@gmail.com](mailto:sescoc@gmail.com)

**DEPARTMENT OF CIVIL ENGINEERING**

A.Y-2021-22 Date: -04/04/2022

**B.E Civil-List of students Enrolled for Industrial visit**

| Sr. No. | Roll No.  | Name of Student             | Sign                                   |
|---------|-----------|-----------------------------|--|
| 1       | BC119D001 | BANDGAR PRIYA ABASO         | <i>[Signature]</i>                     |
| 2       | BC119D002 | BARGE RUTUJA NANDKUMAR      | <i>[Signature]</i><br>AB               |
| 3       | BC118D003 | BELVANKAR SWAPNIL SANJAY    | <i>[Signature]</i><br>AB               |
| 4       | BC119D004 | BHILARE AKSHAY SHANKAR      | <i>[Signature]</i>                     |
| 5       | BC119D005 | BHOSALE RUSHIKESH KAMALAKAR | <i>[Signature]</i><br>Chavan           |
| 6       | BC119D006 | BOBADE SHUBHAM MOHAN        | <i>[Signature]</i>                     |
| 7       | BC119D007 | CHAVAN KUNAL BALASAHEB      | <i>[Signature]</i>                     |
| 8       | BC118D008 | CHAVAN SHUBHAM DEVRAM       | <i>[Signature]</i>                     |
| 9       | BC119D009 | CHAVAN SHUBHAM SHIVAJI      | <i>[Signature]</i>                     |
| 10      | BC119D010 | CHAVARE RUSHIKESH BABAN     | <i>[Signature]</i><br>ANEI<br>Deshmukh |
| 11      | BC119D011 | DESHMUKH HARSHAD ANIL       | <i>[Signature]</i>                     |
| 12      | BC119D012 | ERATKAR SATYAM ARUN         | AB                                     |
| 13      | BC116D013 | GUJALWAD AJAY NIVRUTTI      | <i>[Signature]</i>                     |
| 14      | BC119D014 | GUJAR MRUNAL SHEKHAR        | <i>[Signature]</i>                     |
| 15      | BC119D015 | HIREMATH PAVANKUMAR S.      | <i>[Signature]</i>                     |
| 16      | BC119D016 | INGVALE AKSHAY DATTATRAY    | <i>[Signature]</i><br>Jatap            |
| 17      | BC119D017 | JAGTAP VINAY CHANDRAKANT    | <i>[Signature]</i>                     |
| 18      | BC119D018 | KADAM SHRIDHAR KANTILAL     | <i>[Signature]</i>                     |
| 19      | BC119D019 | KHAMBE PRUTHVIRAJ SHIVAJI   | <i>[Signature]</i>                     |
| 20      | BC118D020 | KHOPADE NIKHIL ATMARAM      | <i>[Signature]</i>                     |
| 21      | BC119D021 | KOKARE YOGITA RAJENDRA      | <i>[Signature]</i><br>OMKAR Korale     |
| 22      | BC119D022 | KORADE OMKAR TANAJI         | AB                                     |
| 23      | BC115D023 | KULKARNI ROHIT RAMAKANTRAO  | AB                                     |
| 24      | BC119D024 | KUMBHARKAR RITESH VIJAY     | <i>[Signature]</i>                     |
| 25      | BC119D025 | KUNJIR ABHIJIT KISAN        | <i>[Signature]</i>                     |
| 26      | BC118F026 | KUNJIR ABHISHEK VIKAS       | <i>[Signature]</i>                     |
| 27      | BC119D027 | KURALE VIJAYA SHRIRANG      | <i>[Signature]</i>                     |



|    |           |                            |                      |
|----|-----------|----------------------------|----------------------|
| 28 | BCI19D028 | MALI ANIKET TANAJI         | M. Tanaji            |
| 29 | BCI19D029 | MALUSARE BHAGYASHRI VIKAS  | Malusari             |
| 30 | BCI17F030 | MANE RUTUJA RAJENDRA       | Putiya               |
| 31 | BCI19D031 | MISAL PRAJAKTA SHARAD      | Prajakta             |
| 32 | BCI19D032 | MOHITE PAYAL SURESH        | Suresh               |
| 33 | BCI18F033 | MORE VAISHNAVI BHANUDAS    | VB More              |
| 34 | BCI19D034 | PARDESHI SWAPNIL RAJENDRA  | R. pendeshi          |
| 35 | BCI19D035 | PATIL PRUTHVIRAJ PANDURANG | AB<br>Dnyandeo Patil |
| 36 | BCI19D036 | PATIL SUDARSHAN DNYANDEV   | Dnyanjay Patil       |
| 37 | BCI17F037 | PATIL SUSHANT SANJAY       | Sushant              |
| 38 | BCI17F038 | PATIL UTKARSH BALASO       | Utkarsh Balaso       |
| 39 | BCI19D039 | PAWALE RAHUL KESHAV        | Rahul                |
| 40 | BCI16D040 | PAWAR PRAVIN PRAKASH       | P. Pawar             |
| 41 | BCI18F041 | PAWAR SHUBHAM ANIL         | Shubham              |
| 42 | BCI17F042 | PHALKE ANIKET ANANDRAO     | Aniket               |
| 43 | BCI16F043 | PHULE SAURABH BALASAHEB    | Phule                |
| 44 | BCI19D044 | RAJEBHOSALE RUSHIKESH V.   | AB                   |
| 45 | BCI19D045 | RANE PRAJWAL GANGARAM      | P. Rane              |
| 46 | BCI19D046 | SABLE DIGVIJAY ROHIDAS     | D. Sable             |
| 47 | BCI19D047 | SARKALE PRAJAKTA SATISH    | Sarkale              |
| 48 | BCI18F048 | SHEDGE PRAJAKTA HIRALAL    | Hiralal              |
| 49 | BCI17F049 | SHINDE ABHISHEK SUNIL      | Abhishek             |
| 50 | BCI19D050 | SHINDE SANDEEP KRISHNA     | AB                   |
| 51 | BCI18F051 | SONAWANE PRAJAKTA SANDESH  | Sonawane             |
| 52 | BCI19D052 | SUKALE VISHAL BHAU         | Vishal               |
| 53 | BCI19D053 | SUTAR VISHAL DINKAR        | Vishal               |
| 54 | BCI19D054 | THOPATE PRITESH NAMDEV     | AB                   |
| 55 | BCI17F055 | VALKUNDE KARAN RAJENDRA    | Val. Karan           |
| 56 | BCI17F056 | VALKUNDE VISHAL JAYWANT    | Vishal               |
| 57 | BCI19D057 | WANKHEDE PRITI VISHWAMBAR  | AB                   |
| 58 | BCI19D058 | YADAV SANDESH SHARAD       | Yadav                |
| 59 | BCI19D059 | ZAGADE ROHIT TUKARAM       | Zagade               |
| 60 | BCI16D060 | SHEDGE NIKHIL SUSHIL       | AB                   |
| 61 | BCI15D061 | CHAVAN CHAITANYA SUBHASH   | AB                   |

Total Strength of Student:



Rajgad Dnyanpeeth's

# Shri Chhatrapati Shivajiraje College of Engineering

Approved by AICTE, New Delhi, Recognized by Govt. of Maharashtra & DTE, Mumbai, and Affiliated to Savitribai Phule Pune University, Pune (ID. PU/PN/Engg./376/2009), DTE CODE : EN3624,

॥ प्रविष्टे गुरुमः श्रेयः ॥



Since-1972

**Anantrao Thopte**  
Founder President, Ex. Edu. Minister

**Sangram Thopte**  
MLA, Executive President

**Sau. Swarupa S. Thopte**  
Hon. Secretary

**Dr. S. B. Patil**  
Principal

RD/SCSCOE/CIVIL/VISIT/2021-22 /

Date: - 04/04/2022

To,  
Managing Director,  
Gayatri Projects Ltd.,  
Hyderabad.

**Subject:-Letter of Gratitude.**

Respected sir,

It gives us immense pleasure in thanking you for allowing an educational visit to Tunnel Construction Project, Khambataki Ghat dated on 04<sup>th</sup> April 2022.

It was a great learning experience for our students, a detailed briefing given by staff is worth appreciation.

Thank you once again for your support and I hope that we will continue to receive your cooperation future.

Thanking You

Yours faithfully

**Head of Department**

Dr. S. S. Sayyed  
Dept. of Civil Engineering  
Shri Chh. Shivajiraje College of Engg  
Dhangawadi, Pune-412206



Received  
4/4/22



# CERTIFICATE OF INTERNSHIP

THIS CERTIFICATE IS PROUDLY PRESENTED TO

**Shubham Tavare**

has successfully completed "Web Development Course"  
from the period of 3rd April 2022 to 6th May 2022.  
During his internship we found the student was dedicated and hard working.



VICE PRESIDENT - HR



## PROPERTY SOLUTIONS (I) PVT.LTD

2 June 2022

### To whom it may concern

Property Solutions India Pvt Ltd Certifies that that

**Mr. Dhonde Abhijeet Vitthal** Successfully completed the internship program from 2 April 2022 to 30 May 2022

During this time Mr. Dhonde Abhijeet Vitthal Displayed professional traits during his internships period and managed to complete all assigned task required . he was hardworking , dedicated ,and committed . It was a pleasure having her with us in this short period



THANK YOU



For Property solution India pvt ltd



24

# CERTIFICATE OF INTERNSHIP

THIS CERTIFICATE IS PROUDLY PRESENTED TO

**Mahesh More** has successfully completed "Web Development Course"

from the period of 2nd April 2022 to 5th May 2022.

During his internship we found the student was dedicated and hard working.

14-05-2022

DATE



*P. Navin*

ACADEMIC HEAD



Date: 02/05/2022

REF NO- ECAD/20/5

### TO WHOM IT MAY CONCERN

This letter is to certify that Mr. OMKAR SANTOSH KARANDE was working with us since, 1 April 2022 to 30 April 2022 as a MECHANICAL CAD DESIGNER at our Bhor branch.

He has wide knowledge in CAD SOFTWARE and also MECHANICAL CAD DRAFTING.

He has performed his duties in diligent and satisfactory manner and was valuable member of E-CADD COMPUTER INSTITUTE.

WE WISH HIM SUCCESS IN HIS FUTURE ENDAVOURS...



DIRECTOR

ER. SHUBHAM S. KHARUSHE

(B.E. MECHANICAL, M TECH CAD/CAM)

E-CADD BHOR



Main Branch : E-CADD 4th Floor, Viraj Avenue, Above Pooja Electronic Manaji Nagar, Narhe, Pune - 411041

Bhor Branch : 3rd Floor, Madhu Savitri Sadan Opp. to Bank of Maharashtra Mangalwar Peth, Bhor, Dist. Pune - 412206

ecadd.bhorbranch@gmail.com

Contact - 8263822481 | 7972179521



Date: 02/05/2022

REF NO- ECAD/20/6

**TO WHOM IT MAY CONCERN**

This letter is to certify that Ms. VAISHNAVI PRADIP KADAM was working with us since, 1 April 2022 to 30 April 2022 as a MECHANICAL CAD DESIGNER at our Bhor branch.

She has wide knowledge in CAD SOFTWARE and also MECHANICAL CAD DRAFTING.

She has performed her duties in diligent and satisfactory manner and was valuable member of E-CADD COMPUTER INSTITUTE.

WE WISH HER SUCCESS IN HER FUTURE ENDAVOURS...



DIRECTOR

ER. SHUBHAM S. KHARUSHE

(B.E. MECHANICAL, M TECH CAD/CAM)

E-CADD BHOR



Main Branch : E-CADD 4th Floor, Viraj Avenue, Above Pooja Electronic Market, Narhe, Pune - 411041

Bhor Branch : 3rd Floor, Madhu Savitri Sadan Opp. to Bank of Maharashtra Mangalwar Peth, Bhor, Dist. Pune - 412206

ecadd.bhorbranch@gmail.com

Contact - 8263822481 | 7972179521



# ILJIN

## ILJIN GLOBAL INDIA PRIVATE LIMITED

Plot A - 2, Phase - II, Khandala MIDC, Village - Kesurdi, Tal - Khandala, Dist - Satara - 412802. Maharashtra, India  
Tel.: 91-2189-227300 www.iljin.com  
CIN No.: U29292PN2016PTC157848

26

Date: 02/05/2022

### CERTIFICATE OF COMPLETION

This is to certify that Mr. Pravin Ankush Sarak ,Student of TE Mechanical Department of RD's SCSCOE ,Bhor ,Pune, has successfully completed internship program in production department from 01/04/2022 to 30/04/2022.

During the period of his internship program with us, he had been exposed to different of processes and was found diligent, hardworking and inquisitive.

We wish the student a very Best of Luck for his future Endeavours.

For ILJIN Global India Pvt.Ltd;

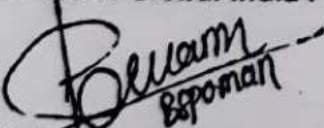
  
Mr. Bhaskar Poman  
Dy. General Manager  
HR & General Affairs





**ILJIN GLOBAL INDIA PRIVATE LIMITED**

Plot A-2, Phase - II, Khandala MIDC, Village - Kesurdi, Tal. Khandala, Dist. Satara - 412802. Maharashtra, India.

Tel. 91-2169-227300 [www.iljin.com](http://www.iljin.com)

CIN No.: U20202PN2016PTC157848

Date: 02/05/2022

## CERTIFICATE OF COMPLETION

This is to certify that **Mr. Atish Sayaji Ghadge**, Student of TE Mechanical Department of RD's SCSCOE, Bhor, Pune, has successfully completed internship program in production department from 01/04/2022 to 30/04/2022.

During the period of his internship program with us, he had been exposed to different of processes and was found diligent, hardworking and inquisitive.

We wish the student a very Best of Luck for his future Endeavours.

For ILJIN Global India Pvt Ltd:

  
B.Poman

**Mr. Bhaskar Poman**  
**Dy. General Manager**  
**HR & General Affairs**



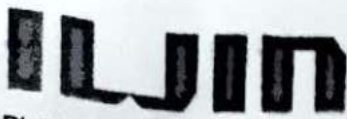

# ILJIN GLOBAL INDIA PRIVATE LIMITED

Plot A-2, Phase - II, Khandala MIDC, Village - Kosurdi, Tal. Khandala, Dist. Satara - 412802. Maharashtra, India.

Tel 91-2169-227300 www.iljin.com

CIN No.: U29202PN2016PTC157848

Date: 02/05/2022

## CERTIFICATE OF COMPLETION

This is to certify that **Mr. Atish Sayaji Ghadge**, Student of TE Mechanical Department of RD's SCSCOE, Bhor, Pune, has successfully completed internship program in production department from 01/04/2022 to 30/04/2022.

During the period of his internship program with us, he had been exposed to different of processes and was found diligent, hardworking and inquisitive.

We wish the student a very Best of Luck for his future Endeavours.

For ILJIN Global India Pvt Ltd;

  
B. Poman

**Mr. Bhaskar Poman**  
**Dy. General Manager**  
**HR & General Affairs**





# ILJIN GLOBAL INDIA PRIVATE LIMITED

Plot A-2, Phase - II, Khandala MIDC, Village - Kesurdi, Tal. Khandala, Dist. Satara - 412802. Maharashtra, India.

Tel.: 91-2169-227300 www.iljin.com

CIN No.: U29292PN2016PTC157848

Date: 02/05/2022

## CERTIFICATE OF COMPLETION

This is to certify that **Mr. Mr. Somanath Ashruba Gade**, Student of TE Mechanical Department of RD's SCSCOE, Bhor, Pune, has successfully completed internship program in production department from 01/04/2022 to 30/04/2022.

During the period of his internship program with us, he had been exposed to different of processes and was found diligent, hardworking and inquisitive.

We wish the student a very Best of Luck for his future Endeavours.

For ILJIN Global India Pvt Ltd;



**Mr. Bhaskar Poman**  
Dy. General Manager  
HR & General Affairs





**ILJIN GLOBAL INDIA PRIVATE LIMITED**

Plot A - 2, Phase - II, Khandala MIDC, Village - Kesurdi, Tal - Khandala, Dist - Satara - 412802. Maharashtra, India.

Tel.: 91-2169-227300 [www.iljin.com](http://www.iljin.com)

CIN No.: U29292PN2016PTC157848

Date: 02/05/2022

## CERTIFICATE OF COMPLETION

This is to certify that **Mr. Rushikesh Pravin Ingulkar**, Student of TE Mechanical Department of RD's SCSCOE, **Bhor, Pune**, has successfully completed internship program in production department from 01/04/2022 to 30/04/2022.

During the period of his internship program with us, he had been exposed to different of processes and was found diligent, hardworking and inquisitive.

We wish the student a very Best of Luck for his future Endeavours.

ILJIN Global India Pvt.Ltd, Shirwal, Pune.s

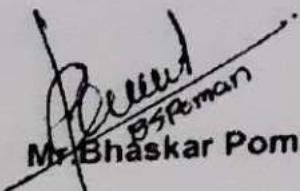
  
Mr. Bhaskar Poman

(GM, HR & General Affairs)





# ILJIN GLOBAL INDIA PRIVATE LIMITED

Plot A -2, Phase-II, Khandala MIDC, Village-Kesurdi, Tal. Khandala, Dist.Satara 412802. Maharashtra, India.

Tel.: -91-2169-227300 [www.iljin.com](http://www.iljin.com)

CIN NO.: U29292PN2016PTC157848

Date:- 02/05/2022

## CERTIFICATE OF COMPLETION

This is to certify that **Mr. Raj Dnyaneshwar Sawant**. Student of TE Electronics and Telecommunication Department of **RD'S SCSCOE, Bhor, Pune**, has successfully completed intership program in production department from 01/04/2022 to 30/04/2022.

During the period of his internship program with us, he had been exposed to different of processes and was found diligent, hardworking and inquisitive.

We wish the student a very Best of Luck for his future Endeavours.

For ILJIN Global India Pvt Ltd;

**Mr. Bhaskar Ponam**  
Dy. General Manager  
HR & General Affairs





**M-CAD**  
TRAINING INSTITUTE

WORKING UNDER M. T. S. T. S.  
GOVT. REG. NO. SAN/MR/J/GNL/O/343/2004  
GOVT OF INDIA ID: DL/2012/0055308  
ISO 9001 : 2008

27

HR/22-23/REC007

Date: 05/05/2022

## Certificate of Training

### To Whomsoever It May Concern

This is to certify that,

**Mr. Kamble Siddhartha Raoso**

of Shri Chhatrapati Shivajiraje college of Engineering, Dhangwadi, Tal.- Bhor, Dist.- Pune,  
Branch- Mechanical Engineering have successfully completed 30 Day (1-04-2022 to 30-04-  
2022) training at our organization.

During the training, students have closely worked as part of our team.

We wish them good luck for all future endeavor & look forward to work with them in the  
near future.

Date: 5-5-2022

For,

M-CAD TRAINING INSTITUTE

Katraj-Kondhwa Road,

Pune



M-CAD Training Institute, Office No. 17, Shri Ganesh Vishwa Society,  
Opp. to Dominos Pizza, Gokul Nagar, Katraj, Kondhwa Road, PUNE - 411 048

83294 90320 / 77749 54433

support@mcad.in



# MAYURESH PLASTICS

28

Gat No- 77, Plot No-06, Jyotiba Nagar, Talawade, Pune - 411062.  
Contact details: 095274 42812, email id: mayureshplastics@yahoo.in  
GST NO:- 27AEQPT6791K1ZF

## INTERNSHIP TRAINING CERTIFICATE

TO WHOMSOEVER IT MAY CONCERN

This is to certify that Mr. Pavan Dhananjay Chougule,  
Mr. Shubham Anil Jagtap, Mr. Shubham Vijay Suryawanshi, &  
Mr. Kartik Prabhakar Bhivate

Student of T.E (Mechanical) of Shri Chhatrapati Shivajiraje college of Engineering has undergone internship Programme in our company during the period 1-04-2022 to 30-04-2022

During this period he had worked hard and learnt Plastic Injection Moulding & VMC machine working in the mechanical industry. We wish him all the best and bright future.

Date: 5-5-2022

Authorized Signatory

Mayuresh plastics

[Type text]



MAYURESH PLASTICS  
GAT NO- 77, PLOT NO- 06, JYOTIBA NAGAR,  
TALAWADE, PUNE - 411 062.





## MAYURESH PLASTICS

Gat No- 77, Plot No-06, Jyotiba Nagar, Talawade, Pune - 411062.  
Contact details: 095274 42812, email Id: mayureshplastics@yahoo.in  
GST NO:- 27AEQPT6791K1ZF

### INTERNSHIP TRAINING CERTIFICATE

TO WHOMSOEVER IT MAY CONCERN

This is to certify that Mr. Pavan Dhananjay Chougule,

Mr. Shubham Anil Jagtap, Mr. Shubham Vijay Suryawanshi, &

Mr. Kartik Prabhakar Bhivate

Student of T.E (Mechanical) of Shri Chhatrapati Shivajiraje college of Engineering has undergone internship Programme in our company during the period 1-04-2022 to 30-04-2022

During this period he had worked hard and learnt Plastic Injection Moulding & VMC machine working in the mechanical industry. We wish him all the best and bright future.

Date: 5-5-2022

Authorized Signatory

Mayuresh plastics



[Type text]

MAYURESH PLASTICS  
GATE NO.77, JYOTIBA NAGAR,  
TALAWADE, PUNE - 411 062



## MAYURESH PLASTICS

Get No- 77, Plot No-06, Jyotiba Nagar, Talawade, Pune - 411062.  
Contact details: 095274 42812, email id: mayureshplastics@yahoo.in  
GST NO:- 27AEQPT6791K1ZF

### INTERNSHIP TRAINING CERTIFICATE

TO WHOMSOEVER IT MAY CONCERN

This is to certify that Mr. Pavan Dhananjay Chougule,

Mr. Shubham Anil Jagtap, Mr. Shubham Vijay Suryawanshi, &

Mr. Kartik Prabhakar Bhivate

Student of T.E (Mechanical) of Shri Chhatrapati Shivajiraje college of Engineering has undergone internship Programme in our company during the period 1-04-2022 to 30-04-2022

During this period he had worked hard and learnt Plastic Injection Moulding & VMC machine working in the mechanical industry. We wish him all the best and bright future.

Date: 5-5-2022

Authorized Signatory

Mayuresh plastics

[Type text]



MAYURESH PLASTICS  
GET NO. 77, JYOTIBA NAGAR,  
TALAWADE, PUNE - 411 062

Ref-SGK/22/12773  
Date-12/05/2022

**INTERNSHIP CERTIFICATE**

This is to certify that Mr. **Abhijit Balasaheb Kale**, of Shri chhatrapati Shivajiraje College of Engineering, Dhangwadi, Tal-Bhor, Dist-Pune, Branch-Mechanical Engineering have successfully 30days from (01/04/2022 to 30/04/2022) training at "Sansera Engineering Ltd." Plant-5B-1B, MIDC, Chakan, Pune.

We found his performance is good and sincere towards the organization .

We wish them good luck for all future endower and look forward to work with them in the near future.

Yours Truly  
For SGK India Industrial Services (P) Ltd.

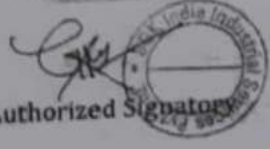
  
Authorized Signatory

**SGK INDIA INDUSTRIAL SERVICES (P) LTD.**  
CIN : U74140OR2010PTC011741

Head Office : PNB Building, 2nd Floor, Bomikhal, Bhubaneswar-751010, Odisha, India  
Branch Office : Airport Road, Viman Nagar, Pune - 411014, Maharashtra  
Tel.: (0674) 2975111, Email: contact@sgkindia.com, Website: www.sgkindia.com



◊ BHUBANESWAR ◊ PUNE ◊ MUMBAI ◊ KOLKATA ◊ DELHI ◊ CHENNAI ◊ BANGALORE ◊ HYDRABAD



# INTERNSHIP TRAINING CERTIFICATE TO WHOMSOEVER IT MAY CONCERN.

This is to certify that Mr. Saurabh sanjay devlekar

Student of T.E (Mechanical) of Shri Chhatrapati Shivajiraje college of Engineering has undergone Internship Programme in our company during the period 1-04-2022 to 30-04-2022.

During this period he had worked and learnt CNC & VNC machine working in the mechanical industry. We wish him all the best and bright future.

Date: 5-5-2022

For,  
Mr. Saurabh sanjay devlekar

Authorised dealer

  
**Vighanharta Enterprises**  
A/p-Kamthadi, Tal Bhor, Dist-Pune.  
Mob:- 9890715101 / 8080999293

Gate no 110, kamthadi, bhor

Vighnahrata Enterprises



# INTERNSHIP CERTIFICATE

**CERTIFICATE**  
of Internship 2022

This certificate is presented to:

**Mayur Ravindra Pawar**

A Student of Savitribai Phule Pune University  
has successfully completed one month of Android  
development internship

  
SIGNATURE





# Lets Grow/More CERTIFICATE of Completion

PROUDLY PRESENTED TO

## Rutuja Pradip Babar

Was an active Participant in the LetsGrowMore Virtual Internship Program  
in Web Development from 1 April 2022 to 1 May 2022



*Aman Kesariwani*

FOUNDER

6 May 2022



Verify Here

Lets  
**Grow/More**  
**CERTIFICATE**  
**OF COMPLETION**

CID-LGMVIR-000002789

PROUDLY PRESENTED TO

**Pratik Adhikrao Sutar**

**Was an active Participant in the LetsGrowMore Virtual Internship Program  
in Data Science from 1 April 2022 to 1 May 2022**



*Pratik Adhikrao Sutar*

00000000

6 May 2022



Verify Here

Lets  
**GrowMore**  
CERTIFICATE  
OF COMPLETION

CID - LGMVIPDS0002148

PROUDLY PRESENTED TO

**Ayush Ashok Parwadi**

Was an active Participant in the LetsGrowMore Virtual Internship Program  
in Data Science from 1 April 2022 to 1 May 2022



*Aman Kesarwani*

FOUNDER

6 May 2022



Verify Here



# CERTIFICATE OF COMPLETION



## Congratulations!

This certificate is proudly presented in the recognition of the completion of Internship at CAD DESK.

|                     |   |
|---------------------|---|
| <u>R P Babar</u>    | <u>Summer Internship In Web Development</u> |
| Name                | Course                                      |
| <u>1- Apr -22</u>   | <u>45 Days</u>                              |
| Start Date          | Duration                                    |
| <u>Web Design</u>   | <u>Caddesk Jaipur</u>                       |
| Software/Technology | Training Centre                             |

His/her association with us was very fruitful and we wish him/her all the best in the future endeavors.

Managing Director

25-May 22  
Awarded on



in an association with

**ITDesk**  
Where Success Begins



**CAD DESK**<sup>®</sup>  
TRAINING • PLACEMENT • SOFTWARE • CONSULTANCY

CAD DESK IS A REGISTERED TRADEMARK OF PARSHI TRAINING AND TECHNICAL SERVICES PVT. LTD.



LED LIGHTING | HIGH PRESSURE DIE CASTING | GEAR CUTTING TOOLS

Inled Technologies LLP  
Head Office: 39/D, Swastik House,  
J.N. Road, Gullekdi,  
Pune - 411 037  
020 - 4141 7080  
www.inledtechnologies.com  
info@inledtechnologies.com

Date : 5<sup>th</sup> Jun.2022

34

**"TO WHOMSOEVER IT MAY CONCERN"**

This is to certify that **Ms. Prajakta Gadhave** had been in the Internship in our Company , effective from **April 2022 To June 2022** . She attended the Internship in all working days during the above period.

During her tenure of service , she was found to be very sincere and hard working .

We wish her best of luck for her future assignments.

For , Inled Technologies LLP

HR & Admin Department.





## HIGHLIGHT ELECTRICALS AND SERVICES

Office: Vishwa Empire, Shop No 91, Baramati- Bhigwan Road, Tal- Baramati, Dist- Pune, 413102  
Mob: (+91) 9763646375; Email: [highlightelectrical2018@gmail.com](mailto:highlightelectrical2018@gmail.com)

19  
35

### TO WHOMIT MAY CONCERN

This is certified that Miss. Priyanka Tanaji Jadhav (E123834) a student of TE Electronics and Telecommunication Shri chatrapati Shivajiraje college of engineering. Has been Successfully completed (1April to 30 April 2022) Internship as a 'Site Engineer' in "Highlight Electrical and Services"

During the period of his internship Period with us he was found punctual, hardworking And inquisitive  
We wish him very success in life.



Authorized Signature



Date-May 09-2022



**TO WHOM SO EVER IT MAY CONCERN**

This is to certify that **Mr. Umesh Ramesh Kokate** a student of **Shri Chhatrapati Shivaji Raje college of Engineering Bhor, Pune** has Completed an-internship in Our organization with the Client **Ideal Designs, Shivnae,Pune** from 1 April 2022 to 8 May 2022.

The internship Program Covered basic Knowledge of Electronics & telecommunication & PCB Design using Altium & Pads. Under The guidance of **Mr .Vaibhav Lanke** During the training, he was found to be punctual, Hardworking, and Sincere to work.

We wish him Good luck and Look Forward to Brilliant success in his career.

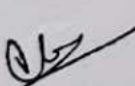
Auth. Signatory

**Vaibhav V. Lanke,**  
Proprietor  
**IDEAL DESIGNS**  
+919960988332 | idealdesigns14@gmail.com



Date-May 09-2022

**TO WHOM SO EVER IT MAY CONCERN**

This is to certify that **Mr. Vishal Shivaji Malavi** a student of **Shri Chhatrapati Shivaji Raje college of Engineering Bhor, Pune** has Completed an internship in Our organization with the Client **Ideal Designs, Shivnae, Pune** from 1 April 2022 to 8 May 2022.

The internship Program Covered basic Knowledge of Electronics & telecommunication & PCB Design using Altium & Pads. Under The guidance of **Mr. Vaibhav Lanke** During the training, he was found to be punctual, Hardworking, and Sincere to work.

We wish him Good luck and Look Forward to Brilliant success in his career.

Auth. Signatory



**Vaibhav V. Lanke,**  
Proprietor  
**IDEAL DESIGNS**  
+919960988332 | idealdesigns14@gmail.com



Flat No.-03, Lotus Court, Shivane  
Pune-411023

Date-May 09-2022

**TO WHOM SO EVER IT MAY CONCERN**

This is to certify that **Mr. Mahendra Rangrao Metil** a student of **Shri Chhatrapati Shivaji Raje college of Engineering Bhor, Pune** has Completed an internship in Our organization with the Client **Ideal Designs, Shivane, Pune** from 1 April 2022 to 8 May 2022.

The internship Program Covered basic Knowledge of Electronics & telecommunication & PCB Design using Altium & Pads. Under The guidance of **Mr. Vaibhav Lanke** During the training, he was found to be punctual, Hardworking, and Sincere to work.

We wish him Good luck and Look Forward to Brilliant success in his career.

Auth. Signatory



**Vaibhav V. Lanke,**  
Proprietor  
**IDEAL DESIGNS**  
**+919960988332 | idealdesigns14@gmail.com**



Date-May 09-2022

**TO WHOM SO EVER IT MAY CONCERN**

This is to certify that **Mr. Dhiraj Suhas Kadam** a student of **Shri Chhatrapati Shivaji Rajee college of Engineering Bor, Pune** has Completed an internship in Our organization with the Client **Ideal Designs, Shivnae, Pune** from 1 April 2022 to 8 May 2022.

The internship Program Covered basic Knowledge of Electronics & telecommunication & PCB Design using Altium & Pads. Under The guidance of **Mr. Vaibhav Lanke** During the training, he was found to be punctual, Hardworking, and Sincere to work.

We wish him Good luck and Look Forward to Brilliant success in his career.

Auth. Signatory

**Vaibhav V. Lanke,**  
**Proprietor**  
**IDEAL DESIGNS**  
**+919960988332 | idealdesigns14@gmail.com**



# Areté Manufacturing Services Pvt. Ltd.

(CIN U74999PN2018PTC177382)

Works : Survey No. 137/1A/4, Dhayari, Sinhgad Road, Pune - 411041. India  
Phone : +91 9130637960 ; E Mail : info@aretems.co.in



## CERTIFICATE OF COMPLETION

This is to certify that Miss. DEEPALI BABURAO KASHID (TET20D019)  
(Third Year Electronics and Telecommunication Engineering) has  
successfully completed the internship in our company from dt. 01.04.2022  
to 30.04.2022.

Her internship activities include familiarization to all the departments, their  
operations and process along with a management overview involved in the  
production process of the organization.

During the period of her internship program with us, she had been exposed  
to different processes.

Date: 30.05.2022



*M. K. Kashid*

Authorized signature

Arete Manufacturing Services Pvt. Ltd.





28 April 2022

INTERNSHIP LETTER

This is to certify that MS. Ankita Balasaheb Kokate was working with us as  
"Trainee engineer "on internship

Date of joining 01 April 2022.

Date of completion 28 April 2022.

Designation at the time of Leaving Trainee engineer.

During this period, she worked under the production Department. Her  
performance was sincere and she was of good conduct.

We wish her every success in life.

From Wimson Pvt. Ltd



DIRECTOR





L. V. SHINDE GROUP®  
SINCE 1983

**Supreme Facility Management Pvt. Ltd.**

(ISO 9001 : 2015 / ISO 14001 : 2015 / SA 8000 : 2014 Company)

- Integrated Facility Management • Employee Transport
- Factory in Factory • Catering Services • HR Services
- Holidays • Entertainment



Date-May 16, 2022

**TO WHOM SO EVER IT MAY CONCERN**

This is to certify that **Miss. Archana Mahadev Patil D/o Mahadev Sahebrao Patil**, a student of **Shri Chhatrapati Shivajiraje College of Engineering** has successfully completed internship in our organization with our client **WIPRO PARI – Shirwal Plant** starting from **01<sup>st</sup> April 2022 to 30<sup>th</sup> April 2022**.

The internship program covered Basic knowledge of Electronics & Telecommunication (E&TC) under the guidance of **Mr.V. G. Mahajan** During the training she was found punctual, hardworking & sincere to work.

We wish her good luck and look forward for brilliant success in her career.

**For Supreme Facility Management Private Limited.**

**Auth. Signatory**



120/121, Building No. A, 1st Floor, Jai Ganesh Vision, Akurdi, Pune - 411 035. Maharashtra, India.

Tel : 020 - 6731 1000/1/2/3 • Fax : 020 - 6731 1000 • Web : [www.supremefacility.com](http://www.supremefacility.com) • Mail : [info@supremefacility.com](mailto:info@supremefacility.com)

9837811000

CIN : U63040PN2005PTC020759



40

REF: HR/PHP/2022/10

17th Mar 2022

## Certificate of Apprenticeship Completion

This is to note that **Shendge, Bhagyashri(SN525)**, was associated as an Apprentice under BOAT scheme from **18-Mar-2021 to 17-Mar-2022** at Phaitan Cummins India Limited, SEZ Unit of Cummins Technologies India Private Limited-Power Systems Business Unit as a Technician Apprentice (Diploma Engineer Trainee).

The performance and behaviour of the candidate was found satisfactory during the apprenticeship and we wish him all the best for all the future endeavors.

For Cummins Technologies India PVT Ltd, PHHP

**Harish Saive**

**PHP HR Lead**



Cummins India Limited  
Registered Office  
Cummins India Office Campus  
Tower A, 5<sup>th</sup> Floor, Survey No. 21, Balewadi  
Pune 411 045 Maharashtra, India  
Phone +91 20 67067000  
Fax +91 20 67067015  
cumminsindia.com  
dil.investors@notes.cummins.com

ON L29112PN1982PLC012276



**Distribution Redefined**

16  
41



## Safexpress pvt ltd

Office address: Near NH 4, opposite of Bharat petroleum, Beside of TCI office, shindewadi, 412801.

Phone No: 7447478129,

Date: 22/05/2022

TO WHOM IT MAY CONCERN.

This is certify that Ms.Kadale shrutika pramod, student of Rajgad Dnyanpeeth Technical Campus, has successfully completed a summer internship in the Safexpress pvt ltd from 15 March to 15 May under guidance of Mr.Anil Jain.

During the period of her internship program with us, she had been exposed to different processes and was found diligent, hardworking and inquisitive.

We wish her every success in her life and career.

For Safexpress pvt ltd.

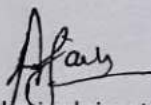

  
Authorized signature.



**INTERNSHIP TRAINING CERTIFICATE  
TO WHOMSOEVER IT MAY CONCERN.**

Date: 28 April 2022

This is to certify that Mr. Bhosale Yash Santosh

Student of T.E (Mechanical) of Shri Chhatrapati Shivajiraje college of Engineering has undergone Internship Programme in our company during the period 09-03-2022 to 27-04-2022. During this period he had worked and learnt DST/TCP procedure and tools operations.

**REPORT OF TRAINING**

| Aspects             | Very good | Good | Fair | Average | Below Average |
|---------------------|-----------|------|------|---------|---------------|
| 1. Conduct          | ✓         | -    | -    | -       | -             |
| 2. Punctuality      | ✓         | -    | -    | -       | -             |
| 3. Knowledge        | ✓         | -    | -    | -       | -             |
| 4. Interview Rating | -         | ✓    | -    | -       | -             |
| 5. Dairy Rating     | -         | ✓    | -    | -       | -             |

We wish him all the best and bright future.

For,

Mr. Bhosale Yash Santosh.

A-771, Koper Khairone  
New Mumbai- 400 710

Expco North Sea Ltd  
**EXPRO NORTH SEA LTD.**



# CERTIFICATE OF INTERNSHIP

PROUDLY PRESENTED TO

## Pooja Balkrishna Gaikwad

For Successfully Completing 1 Month Virtual Internship as a Web Development Intern At CollegeRanker India. During This Internship We Found Him/Her Consistent And Hardworking. We Wish All the Best For Future Endeavors.

**Onkar Mathapati**  
Founder & CEO



**Sarthak Kalpande**  
Co-Founder & CTO



Verify at:

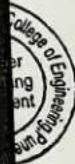

Certificate of Internship



# GeeksforGeeks

A computer science portal for geeks

## CERTIFICATE

We are happy to certify that Mr. Shahrukh Shaikh has done internship as "Software Developer" during 5th March 2022 to 8th April 2022. We appreciate his work and contributions.

*Sanday Jun*

---

Founder & CEO  
GeeksforGeeks



# SHREYAS IT SOLUTIONS



9922769776 

Mahad Pandharpur Road Bhor 

shreyasitsolutions19@gmail.com 

10/05/2022

To  
Attar Asfiyan Nazim  
8007187303

**Sub. – Your Internship with our Shreyas It Solutions.**

Dear Asfiyan

Congratulations to you on your successful completion of your 60Days of internship with the information technology in our organization from 05/03/2022 to 01/05/2022.On java programming.

Your willingness to learn, adapt, showing sensitivity to urgency and involvement in the tasks assigned to you is appreciated by the entire IT team. We are sure you will see success coming to you more easily withthis approach.

We are also happy to hand over your Internship Completion Certificate with this letter.

We wish you all success in your career.

Sincerely,



Shreyas Shete  
Director







# **EGEARZ PRIVATE LIMITED**

SECTOR B, MIDC, SATARA, MAHARASHTRA

Date: 01/04/2022

## **CERTIFICATE**

TO WHOM SO EVER IT MAY CONCERN

This is to certify that **Mr. Pandurang N. Bhalghare**, a student of Mechanical Engineering From **Rajgad Dnyanpeeth's SCSCOE Dhangwadi, Pune** has done "**Industrial Training**" in our organization during the period from 01/03/2022 to 31/03/2022

We found him sincere and well behaved during period of his training.

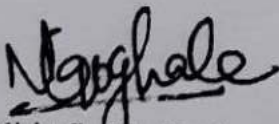
  
Nitin S. Chokhale

Sr. Manager & Admin  
E. GEARZ PVT. LTD.





Rajgad Dnyanpeeth's

Shri Chhatrapati Shivajiraje College of Engineering

Gat No. 237, Pune Bangalore Highway, Dhangawadi, Tal – Bhor, Dist- Pune (Maharashtra)

DEPARTMENT OF COMPUTER ENGINEERING

Ref No: RDTC/SCSCOE/Comp Dept./

Date: 23/02/2022

## NOTICE

All the BE students are hereby informed that an online virtual visit is scheduled to QualEx Systems Pvt. Ltd. at 01/03/2022 Tuesday at 11.30 am. As a part of industrial visit and to have practical knowledge a visit is arranged.

All students should be present in for the visit sharp on 01/03/2022 at 11.15 am. Sessions will starts at 11.30 am sharply.

\*Student's attendance is compulsory

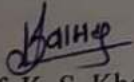
  
Prof. K. S. Khamkar  
Visit Coordinator

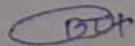

  
Prof. B. D. Thorat  
HOD  
Head of Department  
Dept. Computer Engineering  
Shri Chh. Shivajiraje College of Engg.  
Dhangawadi, Pune-412206



Rajgad Dnyanpeeth's

## Shri Chhatrapati Shivajiraje College of Engineering

Gat No. 237, Pune Bangalore Highway, Dhangawadi, Tal - Bor, Dist- Pune (Maharashtra)

### DEPARTMENT OF COMPUTER ENGINEERING

## REPORT ON VIRTUAL INDUSTRIAL VISIT TO QUALEX SYSTEMS PVT. LTD.

**Department** : - Computer Engineering

**Date** : - 1<sup>st</sup> March 2022

**Duration of Visit** : - 1 Day

**Student Present** : - 62

**Faculties Coordinators** : - Prof. K. S. Khamkar, A. R. Nawadkar, S. B. Shirke

#### 4) **Objective:** -

- To make students understand about research opportunities at industries
- To provide the students with an insight to the internal working of industries
- To get a deep insight about courses offered at industries

#### **Proceeding Visit:** -

A virtual industrial visit to QualEx Systems Pvt. Ltd. was organized by the Department of Computer Engineering to enhance student's knowledge on advance technology and to give an idea about which technology used in industries. Students attended the virtual session at 11.30 AM and were briefed by the Mr. Gaurav Bhatt about QualEx Systems Pvt. Ltd. Mr. Gaurav Bhatt, professional expert, who took over the session, briefed them about the organization and functions QualEx Systems Pvt. Ltd.

The information about back-end coding and hardware required was explained by Mr. Gaurav Bhatt with all other necessary technical qualities. He also gave a lecture on Home automation, illustrating this with examples. He outlined the various services which are given by QualEx Systems Pvt. Ltd. for both Government and private industrial organizations.

The session ended with a hearty thanks and question & answer. Students asked about their doubts regarding the topic discussed and also enquired about how to get an internship in QualEx Systems Pvt. Ltd. Mr. Gaurav Bhatt informed about the various courses that the organization will provide after their final year for students of Computer Engineering.

#### **Visit Outcome:-**

1. The industry visit helps them gain hands-on experience of how industry operations are executed.
2. Industry visits bridge the gap between theoretical training and practical learning in a real-life environment.





Rajgad Dnyanpeeth's

# Shri Chhatrapati Shivajiraje College of Engineering

Gat No. 237, Pune Bangalore Highway, Dhangawadi, Tal – Bhor, Dist- Pune (Maharashtra)

## DEPARTMENT OF COMPUTER ENGINEERING

3. Industry visits provide opportunity for active/interactive learning experiences in-class as well outside the classroom environment.
4. With industry visits, students are able to better identify their prospective areas of work in the overall organizational function.
5. Industry visits help enhance interpersonal skills and communication techniques.
6. Students become more aware of industry practices and regulations during industry visits.
7. Industry visits broaden the outlook of students with exposure to different workforces from different industries.
8. Aware about all other things like Class Unity, financial and supportive responsibilities outside of college.

### Photos during Industrial visit:



Mr. Gaurav Bhatt sir interaction with students during company visit



Project completed by company are well discussed explained with students during Industrial visit



*K. S. Khamkar*  
Visit Coordinator  
Prof. K. S. Khamkar

*B. D. Thorat*  
Head of Department  
Prof. B. D. Thorat  
Head of Department  
Dept. Computer Engineering  
Shri Chh. Shivajiraje College of Engg.  
Dhangawadi, Pune-412206



*S. B. Patil*  
Principal  
Prof. Dr. S. B. Patil  
Principal  
Rajgad Dnyanpeeth's  
Shri Chhatrapati Shivajiraje College of Engg.  
Dhangawadi, Pune-412206



Rajgad Dnyanpeeth's  
Shri Chhatrapati Shivajiraje College of Engineering  
S.No.237,Dhangawadi,Tal - Bhor,Dist - Pune

Department of Computer Engineering

Industrial Visit Attendance

Date : 01/03/2022

Class: BE

| Roll Number | Name of Student               | Attendance |
|-------------|-------------------------------|------------|
| BCO19D01    | Bardade Shubhada Chandrakant  | P          |
| BCO14F02    | Baviskar Ashwinkumar Rajendra | P          |
| BCO19D03    | Bathe Sumit Ramchandra        | A          |
| BCO19D04    | Bhandvalkar Diptee Balaso     | P          |
| BCO19D05    | Bhargude Namrata Rohidas      | P          |
| BCO19D06    | Bhaskare Shrutika Sunil       | P          |
| BCO19D07    | Chavan Pratiksha Balaso       | P          |
| BCO19D08    | Chavan Rushikesh Genba        | P          |
| BCO19D09    | Chikane Payal Bharat          | A          |
| BCO19D10    | Danawale Satyam Dhanaji       | P          |
| BCO19D11    | Dhamal Ankita Vijay           | A          |
| BCO19D12    | Dhane Prajakta Sanjay         | P          |
| BCO18F13    | Dhumal Rohan Satish           | P          |
| BCO18F14    | Dighe Vinayak Shankar         | P          |
| BCO18F15    | Gaikwad Rushikesh Ramdas      | P          |
| BCO18F16    | Gorad Shrutika Gulab          | P          |
| BCO19D17    | Hagawane Samruddhi Santosh    | P          |
| BCO19D18    | Hingmire Namita Prafulla      | P          |
| BCO17F19    | Jadhav Anuja Popat            | P          |
| BCO17F20    | Jadhav Ashish Suresh          | P          |
| BCO17F21    | Jagtap Prathmesh Suresh       | P          |
| BCO19D22    | Jambhaudekar Pranay Ramesh    | P          |
| BCO19D23    | Kapure Meghsham Vinayak       | P          |
| BCO19D24    | Khopade Pratiksha Deepak      | P          |
| BCO19D25    | Khopade Pratiksha Sandeep     | P          |
| BCO19D26    | Khopade Pratiksha Sonba       | A          |
| BCO19D27    | Kothari Maithili Gajkumar     | P          |
| BCO19D28    | Kulkarni Gauri Ramesh         | P          |
| BCO19D29    | Kulkarni Tanvi Sunil          | P          |
| BCO18F30    | Lekawale Pooja Mahadev        | P          |
| BCO19D31    | Mahadik Megha Keshav          | A          |
| BCO19D32    | Mahamuni Hrishikesh Narendra  | P          |
| BCO18F33    | Malusare Kajal Sunil          | P          |
| BCO18F34    | Mandake Utkarsha Uday         | P          |
| BCO19D35    | Mane Pratiksha Dattatraya     | A          |



|          |                            |   |
|----------|----------------------------|---|
| BCO15F36 | Margaje Nikita Suryakant   | P |
| BCO19D37 | More Samruddhi Shamrao     | P |
| BCO18F38 | Morya Sandip Suresh        | P |
| BCO19D39 | Mulani Minaj Aslam         | A |
| BCO19D40 | Nale Pratiksha Manik       | P |
| BCO17F41 | Nannaware Rohini Vikram    | P |
| BCO19D42 | Nigade Rutuja Anil         | P |
| BCO19D43 | Nikam Rutuja Sarjerao      | P |
| BCO18F44 | Papal Mahesh Shivaji       | P |
| BCO18F45 | Parkhade Priyanka Rohidas  | P |
| BCO19D46 | Pawar Neha Somnath         | P |
| BCO19D47 | Pawar Pranali Prakash      | P |
| BCO18F48 | Pawar Sneha Sunil          | P |
| BCO19D49 | Pujari Gauri Somnath       | P |
| BCO17F50 | Rathod Bhimrao Devidas     | P |
| BCO19D51 | Raut Pratiksha Sunil       | P |
| BCO19D52 | Renose Asmita Ramesh       | P |
| BCO18F53 | Salunke Vivek Sharad       | P |
| BCO17F54 | Sarwade Vikrant Ashok      | P |
| BCO19D55 | Satpute Monali Rajendra    | A |
| BCO19D56 | Savale Omkar Shatrughna    | P |
| BCO18F57 | Shendkar Ketan Dhananjay   | P |
| BCO19D58 | Shewale Prathamesh Prakash | P |
| BCO19D59 | Shingade Vidya Namdev      | P |
| BCO19D60 | Shirke Anushka Vijay       | P |
| BCO19D61 | Shirke Nishigandha Kundlik | P |
| BCO19D62 | Shirke Snehal Dilip        | P |
| BCO18F63 | Solat Soham Santosh        | P |
| BCO18F64 | Solat Someshwar Ramesh     | P |
| BCO18F65 | Taware Kajal Hanumant      | P |
| BCO19D66 | Ubhe Rutvik Baban          | P |
| BCO18F67 | Vedpathak Dnyanal Kumar    | A |
| BCO18F68 | Waghmode Tushar Maharudra  | P |
| BCO19D69 | Walmiki Shivani Amit       | P |
| BCO18F70 | Yadav Poonam Ramesh        | P |
| BCO18F71 | Yadav Revati Vishvanath    | A |
| BCO16D72 | Bhosale Priyanka Hiralal   | P |



*K. H. H.*



Rajgad Dnyanpeeth's

## Shri Chhatrapati Shivajiraje College of Engineering

Gat No. 237, Pune Bangalore Highway, Dhangawadi, Tal - Bhor, Dist- Pune (Maharashtra)

### DEPARTMENT OF COMPUTER ENGINEERING

Date: 01/03/2022

To,  
QualEx Systems Pvt. Ltd,  
Pune

**Subject:** Expression of gratitude.

Dear Sir/Madam

This is an appreciation for your valuable time and interest for successfully conduction of virtual visit of your industry dated 01/03/2022 Thursday for students of our Institute.

We are very thankful to you for sharing your knowledge, experience and sparing time to guide our students. Hope you will extend your support and cooperation in future also

Thanking you.

B

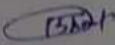
  
Prof. B. D. Thorat

**HOD**

**Head of Department**  
Dept. Computer Engineering  
Shri Chh. Shivajiraje College of Engg.  
Dhangawadi, Pune-412206



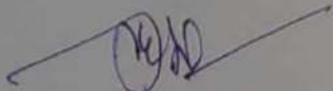

Prof. Dr. S. B. Patil

**Principal**

Rajgad Dnyanpeeth's  
Shri Chhatrapati Shivajiraje College of Engg.,  
Dhangawadi, Pune-412206



48



**CERTIFICATE**  
**Abstract IT Solutions**  
Computer & Engineering Classes

Head Office - Pagar Plaza, Phase II, Office No. 9, Bharat Vihar, PICT College,  
Tendur Chowk, Karaj, Pune - 411046.

Date: 07/05/2022

Certified that Mr./Mrs./Miss. DEBS SUNANDA MUKTARAM  
has completed the PYTHON - DATA SCIENCE course in  
INTERNSHIP of 02 months  
duration from 1<sup>st</sup> Mar - 2022 to 1<sup>st</sup> May - 2022 with grade A

Sign. of  
Branch Manager



Sign. of  
Director







**Spectris Technologies Pvt Ltd**

## **INTERNSHIP CERTIFICATE**

**This certificate is presented to**

**Basavaraj Bhimanavaru**

**For completing his internship program from 1<sup>st</sup> March to April 30, 2022.**

**Given this June May 02, 2022.**

**During his association with us, we found him to be hard working and a keen learner. We wish him success in his future endeavors.**

**HR Manager  
Krisha Das**



**Spectris Technologies Pvt Ltd**

## **INTERNSHIP CERTIFICATE**

**This certificate is presented to**

**Sandeep Ghatkamble**

**For completing his internship program from March to April 30, 2022.**

**Given this June May 02, 2022.**

**During his association with us, we found him to be hard working and a keen learner. We wish him success in his future endeavors.**

**HR Manager  
Krisha Das**



**Spectris Technologies Pvt Ltd**

## **INTERNSHIP CERTIFICATE**

**This certificate is presented to**

**Ganesh Pawar**

**For completing his internship program from March to April 30, 2022.**

**Given this June May 02, 2022.**

**During his association with us, we found him to be hard working and a keen learner. We wish him success in his future endeavors.**

**HR Manager  
Krisha Das**





L&D INFOTECH PVT. LTD.  
CONNECTIVITY WITH WORLD

Date: 05/05/2022

### INTERNSHIP CERTIFICATE

This is to certify that Miss. Pratiksha Pandurang Salunke has completed her internship in Python-Data Science at L&D Infotech Pvt. Ltd. Pune from 1-Mar-2022 to 1-May-2022.

During the internship, she demonstrated good design skills with a self-motivated attitude to learn new things. Her performance is satisfactory.

We wish you all the best for your future endeavours.



L&D Infotec. Pvt. Ltd  
MRS. Manisha L.  
Director





L&D INFOTECH PVT. LTD.  
CONNECTIVITY WITH WORLD

Date: 05/05/2022

### INTERNSHIP CERTIFICATE

This is to certify that Miss. Nilam Ramesh Gadekar has completed her internship in Python-Data Science at L&D Infotech Pvt. Ltd. Pune from 1-Mar-2022 to 1-May-2022.

During the internship, she demonstrated good design skills with a self-motivated attitude to learn new things. Her performance is satisfactory.

We wish you all the best for your future endeavours.



L&D Infotec Pvt. Ltd  
MRS. Manisha L

Director



CIN-U74999PN2019PTC183714



L&D INFOTECH PVT. LTD  
CONNECTIVITY WITH WORLD

Date: 05/05/2022

### INTERNSHIP CERTIFICATE

This is to certify that Mr. Rushikesh Narayan Gade has completed her internship in Python-Data Science at L&D Infotech Pvt. Ltd. Pune from 1-Mar-2022 to 1-May-2022.

During the internship, she demonstrated good design skills with a self-motivated attitude to learn new things. Her performance is satisfactory.

We wish you all the best for your future endeavours.

*Manisha L.*

L&D Infotec Pvt. Ltd  
MRS. Manisha L

Director





L&D INFOTECH PVT. LTD.  
CONNECTIVITY WITH WORLD

Date: 05/05/2022

### INTERNSHIP CERTIFICATE

This is to certify that **Mr. Kanade Omkar Rajesh** has completed his internship in Python-Data Science at L&D Infotech Pvt. Ltd. Pune from 1-Mar-2022 to 1-May-2022.

During the internship, he demonstrated good design skills with a self-motivated attitude to learn new things. His performance is satisfactory.

We wish you all the best for your future endeavours.



L&D Infotech Pvt. Ltd  
Mrs. Manisha L.  
Director





L&D INFOTECH PVT. LTD.  
CONNECTIVITY WITH WORLD

Date: 5/05/2022

### INTERNSHIP CERTIFICATE

This is to certify that Miss. Gauravi Sopan Jagtap has completed her internship in Python-Data Science at L&D Infotech Pvt. Ltd. Pune from 1-Mar-2022 to 1-May-2022.

During the internship, she demonstrated good design skills with a self-motivated attitude to learn new things. Her performance is satisfactory.

We wish you all the best for your future endeavours.



L & D Infotech Pvt.Ltd  
Manisha L  
Director







L&D INFOTECH PVT. LTD.  
CONNECTIVITY WITH WORLD

Date: 5/05/2022

### INTERNSHIP CERTIFICATE

This is to certify that Mr. Yewale Yash Dattatray has completed his internship in Python-Data Science at L&D Infotech Pvt. Ltd. Pune from 1-Mar-2022 to 1-May-2022.

During the internship, he demonstrated good design skills with a self-motivated attitude to learn new things. His performance is satisfactory.

We wish you all the best for your future endeavours.



L&D Infotech Pvt. Ltd  
Mrs. Manisha L.  
Director



CIN-L74000PN2019PTC183/14



L&D INFOTECH PVT. LTD.  
CONNECTIVITY WITH WORLD

Date: 3/05/2022

### INTERNSHIP CERTIFICATE

This is to certify that **Miss. Sanawane Sonal Eknath** has completed her internship in Python-Data Science at L&D Infotech Pvt. Ltd. Pune from 1-Mar-2022 to 1-May-2022.

During the internship, she demonstrated good design skills with a self-motivated attitude to learn new things. Her performance is satisfactory.

We wish you all the best for your future endeavours.



L & D Infotech Pvt Ltd  
Manisha L.  
Director

© 2011, 10th Floor, Bhamburda Emerald, Chhatrapati Shahu Maharaj Road, Near Bharti Hospital, Katraj, Pune, Maharashtra 411043.

41 - 2607607/307 / 91 - 260307 / 4115

info@lndinfotech.com

www.lndinfotech.com





L&D INFOTECH PVT. LTD.  
CONNECTIVITY WITH WORLD

Date: 1/03/2022

### INTERNSHIP CERTIFICATE

This is to certify that Mr. Dipak Naresh Shinde has completed his internship in Python-Data Science at L&D Infotech Pvt. Ltd. Pune from 1-Mar-2022 to 1-May-2022.

During the internship, he demonstrated good design skills with a self-motivated attitude to learn new things. His performance is satisfactory.

We wish you all the best for your future endeavours.



L & D Infotech Pvt. Ltd  
Mrs. Manisha L  
Director





L&D INFOTECH PVT. LTD.  
CONNECTIVITY WITH WORLD

Date: 5/05/2022

**INTERNSHIP CERTIFICATE**

This is to certify that **Miss. Snehal Sunil Pawar** has completed her internship in Python-Data Science at L&D Infotech Pvt. Ltd. Pune from 1-Mar-2022 to 1-May-2022.

During the internship, she demonstrated good design skills with a self-motivated attitude to learn new things. Her performance is satisfactory.

We wish you all the best for your future endeavours.



L & D Infotech Pvt.Ltd  
Manisha L  
Director



2  
51



# in Yantra

Your Partner For PCB Assembly  
Electronics Manufacturing Services.

**Manufacturing Facility: in Yantra Technologies Pvt.  
LTD. Post Shirwal , Tal Khandala , satara-412801**

**Phone no:9028387722**

**Email: info@inyantra.com**

## CERTIFICATE OF INTERNSHIP

This is to certify that Ms. Arati Namdev Khopade. successfully completed internship at INYANTRA PVT.LTD. form 1 march to 31 march 2022.

We found her hardworking and inquisitive. She was very much interested to learn related work and put her effort and also get it to the depth of the subject to understand it better .She was doing testing of PCBs And Visual Inspection of PCBs. We wish her a great success in the future.

Sincerely,

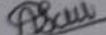
  
Ankita Desai

(Technical Guide).



InYantra Pvt.LTD



# inYantra

Your Partner For PCB Assembly  
Electronics Manufacturing Services.

**Manufacturing Facility: in Yantra Technologies Pvt  
LTD. Post Shirwal ,Tal Khandala , satara-412801**

**Phone no:9028387722**

**Email: [info@inyantra.com](mailto:info@inyantra.com)**

## CERTIFICATE OF INTERNSHIP

**This is to certify that Ms. Komal Sanjay Malekar. successfully completed internship at INYANTRA PVT.LTD. form 1 march to 31 march 2022.**

**We found her hardworking and inquisitive. She was very much interested to learn related work and put her effort and also get it to the depth of the subject to understand it better .She was doing testing of PCBs And Visual Inspection of PCBs. We which her a great success in the future.**

**Sincerely,**

Ankita Desai.

**(Technical Guide)**



inYantra PVT.LTD



DATE: 06<sup>th</sup> June 2022

## CERTIFICATE

This is to certify that **Miss. Archana Sitaram Renuse** studying Diploma (E&TC), in Rajgad Dnyanpeeth Shri Chatrapati Shivajirao College of Engineering Dhangawadi, Pune has completed the internship in our organization during the period **01<sup>st</sup> Mar 2022 to 31<sup>st</sup> Mar 2022.**

We wish Miss. Archana Sitaram Renuse all the best in her future endeavors.

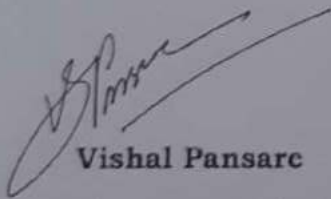

**Vishal Pansare**

**Manager HR & Admin**



52

**VARDHAN CONSULTING ENGINEERS**

MIDC SHIROLI DIST-KOLHAPUR MAHARASHTRA

Date: 24/03/2022

**CERTIFICATE**

TO WHOM SO EVER IT MAY CONCERN

This is to certify that **Mr. Abhishek G. Bendre**, a student of Mechanical Engineering From **Rajgad Dynanpeeth's SCSCOE Dhangwadi, Pune** has done "**Industrial Training**" in our organization during the period from 28/02/2022 to 22/03/2022

We found him sincere and well behaved during period of his training.



Vijay P. Pawar

Sr. manager & Coordinator

Vardhan Consulting Engineers







Rajgad Dnyanpeeth's  
**SHRI CHHATRAPATI SHIVAJIRAJE COLLEGE OF  
ENGINEERING**

S. No. 237, Satara-Pune, NH-4, Dhangawadi, Tal: Bhor, Dist: Pune

## INDUSTRIAL VISIT REPORT

At

**VCB Electronics Pvt. LTD.**

**Khedshivapur**

**(For A.Y. - 2021-22)**

**Savitribai Phule Pune University Pune, India**





Rajgad Dnyanpeeth's

**SHRI CHHATRAPATI SHIVAJIRAJE COLLEGE OF ENGINEERING**

Gat No. 237, Pune Bangalore Highway, Dhangawadi, Tal – Bhor, Dist- Pune (Maharashtra)

**Dept.: E&TC Engineering**

**Date: - 25<sup>th</sup> Feb 2022**

**Academic Year: 2021-22**

### **Industrial Visit Report**

- 1) **Class:** T.E ,B.E- E&TC
- 2) **Name of Company:** VCB Electronics Pvt LTD. Gat No. 760, Khedshivapur,Pune.
- 3) **Date & Time:** Tuesday, 22/02/2022, 10:00 a.m to 4:00 p.m.
- 4) **Present Students:** 70 Students -5 Batches(15 Students).
- 5) **Contact Person with Designation & Phone No.:** Ms. Damini Mahangare , +91-78881 73534
- 6) **Name of Faculty:** Prof. R.S. Nipanikar & Prof. P.S.Gham.

#### **Industry Profile:**



**VCB Electronics Private Limited** is a company incubated in 2001 with the aim to provide a dedicated facility for fabrication, testing and evaluation of avionics packages. Now VCB has world class manufacturing facility for thick film hybrid microcircuits and electronics module assembly

VCB is located at Pune and the core management team comprises highly qualified, experienced professionals, technocrats and experts in design, fabrication, automated electrical testing, environmental testing and quality assurance functions for the products like hybrid microcircuits, chip and wire bonding, electronics module assembly using SMD and leaded soldering techniques essential for space & avionics applications.

Main focus of VCB Electronics is to fulfill the requirements of Indian Space Research Organizations (ISRO), Defense Research and Development Organization (DRDO) and Defense Public Sector Units (DPSU).



VCB Electronics strength is in design, manufacturing and reliability testing of the DC-DC converters for space and military application

VCB is an ISO 9001:2015 certified private limited company in the field of HI-RELIABILITY Electronics with main focus to fulfill the requirements of Indian ecosystem.

### **Objective of the event:**

- To gain hands-on experience of how industry operations are executed
- To better identify their prospective areas of work in the overall organizational function.
- To enhance interpersonal skills and communication techniques
- To know about the demands of the industries.
- To transform the students to competent and committed engineers meeting the demands of present as well as future.

### **Outcome of the Event:**

Student learning outcomes of the visits and talks include the ability to:

1. Demonstrate the applications of engineering concepts and principles learned in classroom.
2. Illustrate processes and products manufactured in the industries.
3. Develop awareness of the engineering and technological aspects in the industries.
4. Improve interpersonal skill by communicating directly with industrial personnel.
5. Aware of the impacts of industrial processes on health, safety, environment and society and also the roles and ethics of engineers in related industries.

### **Description / Report on Event:**

The department of E&TC organized an industrial visit for one-day visit to VCB Electronics, Khedshivapur, This visit was organized on 22<sup>nd</sup> February 2022. For the class of SE/TE/BE Students from E&TC Engineering Department. This visit was approved by **Dr. S.B.Patil (Principal)** and **Prof. T.M.Dudhane (HOD, E&TC Department)** of **RD's SCSCOE, Dhangawadi**. Along with these professors, **Ms. R.S. Nipanikar (Assistant Professor, E&TC Department)**, **Ms. P.S,Gham (Assistant Professor, E&TC Department)** and **Mr. Amol Kamble (Lab Assistant)**, have taken efforts to make this visit a success. Total 75 students of class S.E., T.E & B.E (E&TC) along with 3 faculty members have joined this industrial visit. Main aim industrial visit is to provide an exposure to students about practical working environment. They also provide students a good opportunity to gain awareness about industrial practices.

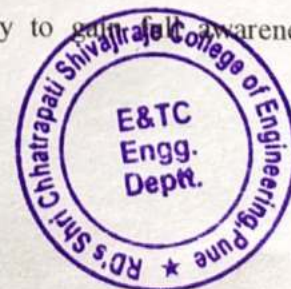

The various departments and machines used in industry is as follows

## 1. Hybrid Micro Circuit Manufacturing



VCB Electronics has complete infrastructure for Hybrid Micro Circuit Manufacturing. VCB can do Thick Film Printing, Firing, Trimming, Scribing Process to manufacture ceramic substrates, on which the SMD components are assembled and soldered using reflow process. Then chips and dies are assembled using epoxy and wire bonding enables the connection from pads on the chip to the pads on the substrate. After Testing, substrates get assembled into a metal package, followed by sealing of the packages and complete validation and screening process as needed prior to delivery to customers.

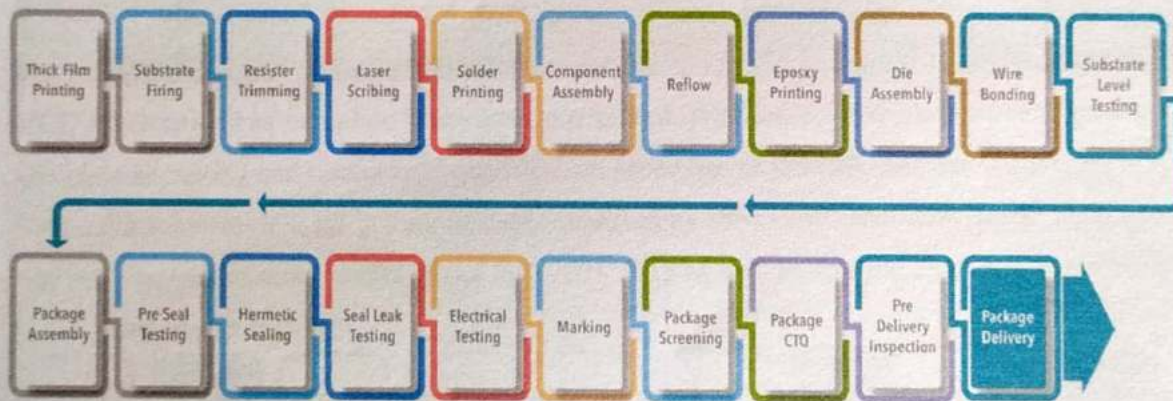

## 2. Space Grade & Industrial Grade Module Assembly

VCB has a complete in-house facility for assembling the space and military grade electronics modules as well as Industrial grade modules. VCB follows a very strong inward quality assessment (IQA) process including 100% visual inspection, LOT Acceptance tests for components, semiconductors, substrates, pastes and epoxies. VCB also assesses shelf life of these items as well as status of equipment, instruments, jigs and fixtures and carries out needed calibration. VCB also validates the entire process and parameters and establishes traceability as needed by customers.

VCB has complete in house solder printing, component assembly, automated pick and place machines, reflow and wave soldering machines, complete testing lab and pre-delivery inspection

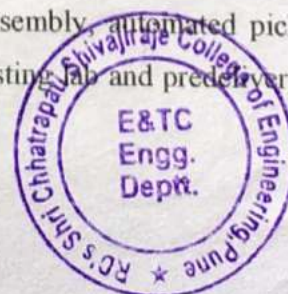

infrastructure. VCB also gets their man power resources qualified to the required process skills, standards and customer expectations.

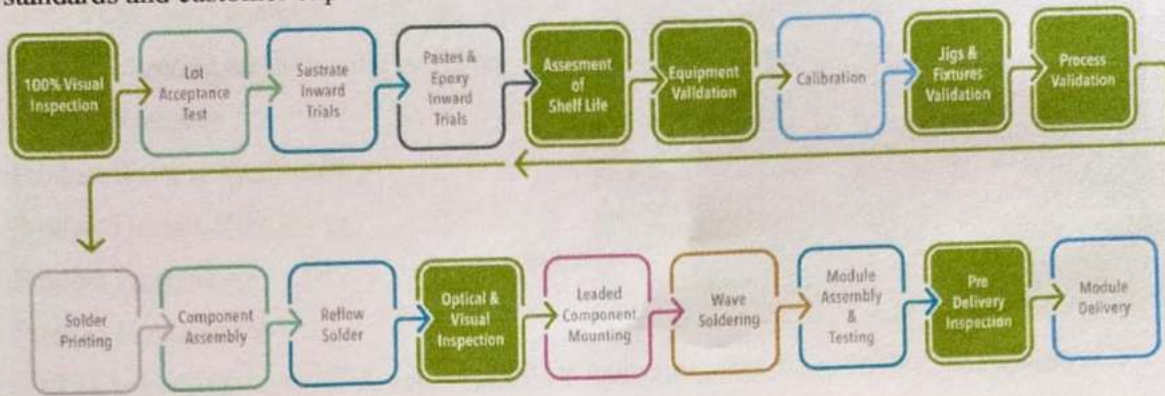

### 3. Screening & Environmental Testing Infrastructure.



VCB Electronics has complete knowhow, equipment, jigs and fixtures, instruments needed for complete screening and circuit type qualification processes as per MIL 883 standards. This environmental test lab got audited and qualified by ISRO and other customers. VCB carries our periodic assessments, audits as per ISO 9001:2015 as well as specific customer guidelines.

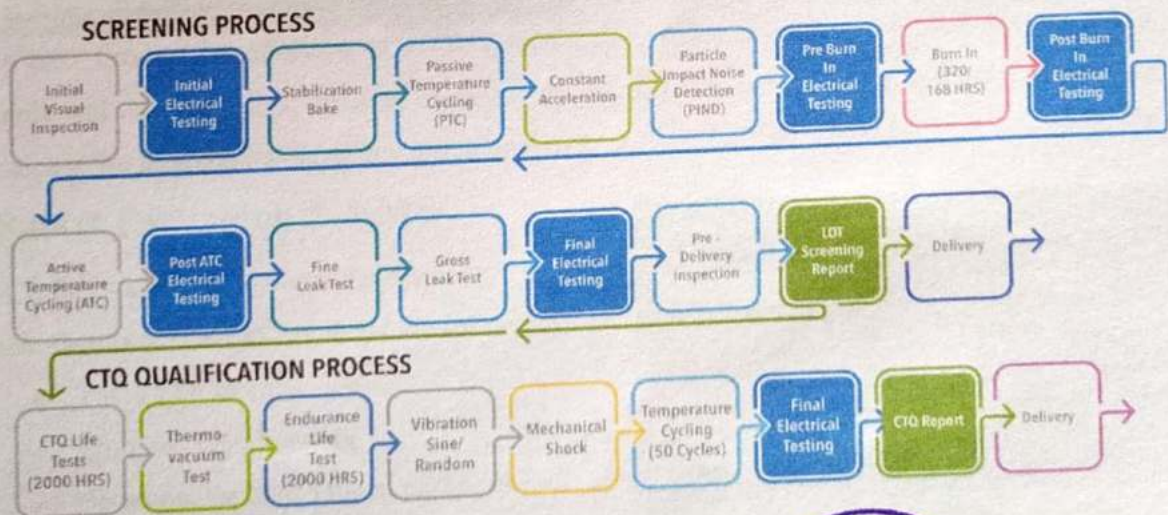

## 4. Design Studio

VCB has complete in-house Design Studio for carrying out following activities

- Product Research
- Product Reverse Engineering
- Product Design and Costing
- Product Prototyping
- Product Compliances

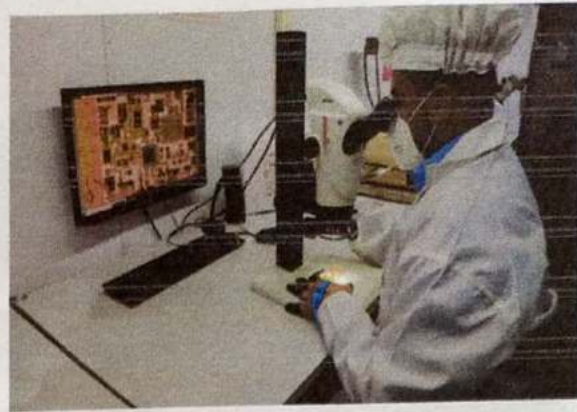

VCB has computer aided design system for thick film, thin film, printed circuit boards, and mechanical parts and have partners to manufacture needed mechanical parts. VCB engineers are competent to build your concepts into working prototypes.

## 5. SCM & NPI

VCB has built good relationships with strategic vendors, material, components and equipment suppliers and other supply chain partners who are critical for delivering on the High Reliability Manufacturing vision.

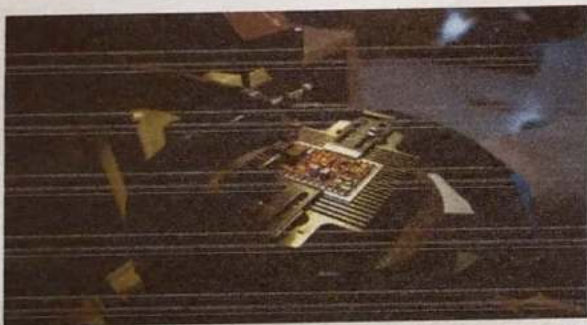

Based on the bill of materials, VCB can quickly identify as needed, procure for testing, qualify the vendors to ensure that quality & reliability goals are met and exceeded.

Design, Production Engineering and Testing Engineers from VCB can assist the customers

in New Product Introduction on to the manufacturing lines by ensuring by making production tools and assembly jigs, fixtures, stencils, etc. so that the sample, pilot and mass production batches are produced without any glitch or errors.

## 6. Smart Packaging & EMS

VCB has smart packaging and electronics manufacturing services set up for the following

- Thick film circuits
- Chip and wire bonding
- Hermetically sealed metal packages
- Modules and sub assemblies
- Turnkey SMT assembly, pick and place and box building



VCB manufacturing lines are qualified for space, defense and industrial customer requirements, processes and quality standard



## 7. Test Engineering & Labs

They can provide customer with complete traceability from the inward inspection all the way along the production line, testing and quality assurance processes, final outward inspection stage, meeting the customer's product compliance requirements.

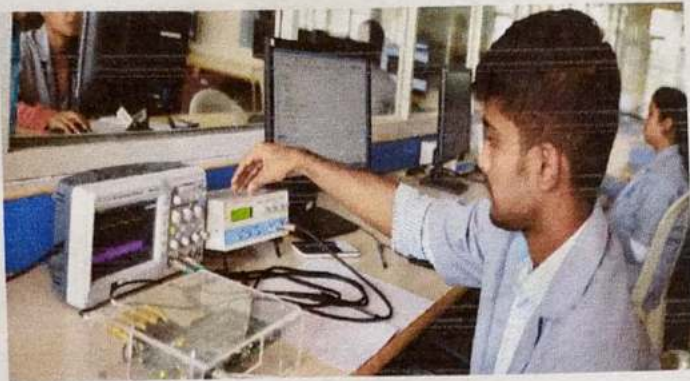

Expert team can design needed test jigs, write test software for measurements, characterization, functional validation, go-no-go tests, batch clearances, reliability testing, module or circuit screening and qualification etc.

They have complete qualification lab and screening facility, test chambers, equipment, instruments, test jigs and fixtures needed to meet military, space and industrial grade compliance requirements.

### Visit Photographs:





Group Photo at VCB Electronics Pvt.Ltd.

*Rahim*

Prof. R.S.Nipanikar

Coordinator



*T.M. Dudhane*

Prof. T.M. Dudhane

HOD

**Head of Department**  
Dept. of E& TC Engineering  
Skri Chh. Shivajiraje College of Engg.  
Dhangawadi, Pune-412206



# CERTIFICATE OF INTERNSHIP

54

## CERTIFICATE OF COMPLETION

3/2/2022

This certificate is proudly presented to

Tujay Kamalakar Korade

for successful completion of 1 month internship in  
**Web Development and Designing**  
with wonderful remarks at **OASIS INFOBYTE**



contact@oasisinfobyte.in

020-2787374

www.oasisinfobyte.in





SHRI PANDURANG PRATISHTHAN PANDHARPUR,  
**KARMAYOGI INSTITUTE OF TECHNOLOGY**

GAT No. 124, 125, AT POST SHELVE, PANDHARPUR, MAHARASHTRA INDIA - 413304  
(APPROVED BY AICTE, NEW DELHI, RECOGNIZED BY GOVT. OF MAHARASHTRA  
AND AFFILIATED DR. BABASAHEB AMBEDKAR TECHNOLOGICAL UNIVERSITY, LONERE)  
www.karmayoginstitute.ac.in

55



✉ principalkec6326@gmail.com  
☎ +91 8554006300

**INSTITUTE CODE 6326**

Ref. No. KEC/Admin/2021-22/ 1107

Date: - 22/01/2022

To,  
Prof. S.I. Nipanikar,  
Associate Professor,  
Dept. of E&TC,  
RD's, SCSCOE, Dhangwadi, Pune

**Subject:-**Letter of gratitude....

Dear Sir,

This is an appreciation for your valuable time and interest in conduction of online Expert Lectureon, "**Digital Image Processing**" on 20/01/2022 in our Institute. Around 60 students from Electronics & Telecommunication Engineering stream were present for valuable session. As per student feedback the session was beneficial to enhance their knowledge and skills in this particular area

We are thankful for sharing your valuable time for our students and hope you will extend the same cooperation in future also

Thanking you



  
Principal

DATE :-10/05/2022

## WORK EXPERIENCE CERTIFICATE

This is to inform whomsoever it may concern and certify that Mr.GajendraSambhajiKshirsagar is working as full-time employee with **S.R.Construction** as **Junior site engineer** in construction department from **20/01/2021 to 20/03/2022** as per the personal file and company's employment record. During his employment, we found **Mr. Gajendra SambhajiKshirsagar** to be a professional, knowledgeable and result oriented with theoretical and practical understanding of work requirements. He has successfully completed jobs in Structure related training programmers administered by the training department of the company. He has a friendly, outgoing personality, very good sense of humor and works well as an individual or member of a team as required by the management, Overall, **Mr. Gajendra SambhajiKshirsagar** performing his duties and responsibilities cheerfully with attention to detail at all times. With his enthusiasm to work, learn and progress, I am certain that he would make a great employee to any enterprise.

Please feel free to contact us if you have specific questions regarding his employment. On behalf of the company, I take this opportunity to wish **Mr. GajendraSambhajiKshirsagar** all the very best in his future career endeavors.



Shraddha Associates

Planning and construction

*Boikarad*  
10/5/2022



57

# STP DEVELOPER'S

Site Address : Gat No. 1037, Neer N.H.4. Opp. Shirke Company, Shirwal, Tal Khandala, Dist. Satara 412801  
Call - 7058911852,7058911853, 9881029970  
Email : stp777@gmail.com

This is to certify that Nikhil Dilip Dhadave pursuing his BE,3<sup>rd</sup> year has  
Successfully completed winter internship at Shirwal from 15<sup>th</sup> January 2022 to 10 April 2022  
(3 month training)

We found him sincere, hardworking, technically sound and result oriented.

He Worked well as part of a team during her tenure, we take this opportunity to  
thank him and Wish him all the best for her future.

Name:-Nikhil Dilip Dhadave

DESIGNATION:-junior Engineer

Place:-Shirwal

Date :-15.4.2022





# STP DEVELOPER'S

Site Address : Gat No. 1037, Neer N.H.4. Opp. Shirke Company, Shirwal, Tal Khandala, Dist. Satara 412801  
Call - 7058911852,7058911853, 9881029970  
Email : stp777@gmail.com

This is to certify that Omkar Shambhaji Mohite pursuing his 3<sup>rd</sup> year has  
Successfully completed winter internship at Shirwal from 15<sup>TH</sup> January 2022 to 10 April 2022  
(3 month training)

We found him sincere, hardworking, technically sound and result oriented.  
He Worked well as part of a team during her tenure. we take this opportunity to  
thank him and Wish him all the best for her future.

Name:-Omkar.S.Mohite

DESIGNATION:-junior Engineer

Place:-Shirwal

Date :-15.4.2022





Date: 31/05/2022

**To Whomsoever It May Concern**

It is certified that **Ms. Girigosavi Jyoti Balu** has satisfactorily completed his **1 Month** internship program from **15 Jan 2022 to 15 Feb 2022** in **Shree Venkatesh Buildcon**

Site Name : **Venkatesh Skydale.**

During his Internship Period he worked in Engineering Department Emphasis On Field Training.

During the period his conduct and character were good.

We wish his success in his future endeavors.

Yours Faithfully,

Mr. Swapnil Suray  
Vice President  
Shree Venkatesh Buildcon  
HR & Admin Department



Date: 31/05/2022

**To Whomsoever It May Concern**

It is certified that **Ms. Jadhav Shital Subhash** has satisfactorily completed her **01 Month** internship program from **15-01-2022** to **15-02-2022** in **Shree Venkatesh Buildcon**.

Site Name: **Venkatesh Skydale.**

During her Internship Period she worked in Engineering Department Emphasis on Field Training.

During the period her conduct and character were good.

We wish her success in her future endeavors.



Mr. Milind Kadam  
Site-PM  
Shree Venkatesh Buildcon





# OMKAR CONSTRUCTIONS

R.C.C. & Construction Work will done at Reasonable Rate.

Opposite Panchayat Samiti , Bajrang Ali , Bhor , District :- Pune 412206

Email : [sameermore80@gmail.com](mailto:sameermore80@gmail.com)

Mo. : 9823337749

Date : 13/04/2022

## TO WHOM IT MAY CONCERN

This is to certify that **Ms. More Gouri Pravin** student of RDTC Dhangwadi , pursuing T.E. Civil has successfully completed field internship of winter vacation at **Omkar Constructions, Bhor**. Dated from 15/01/2022 to 10/04/2022 under the guidance of **Er. More Sameer** .

During the period of training ,she was found punctual and she is sincere about gaining the field knowledge.

OMKAR CONSTRUCTIONS



5

OMKAR CONSTRUCTIONS



DATE :-10/05/2022

**WORK EXPERIENCE CERTIFICATE**

This is to inform whomsoever it may concern and certify that Mr. PandurangKishanrao Bhave is working as full-time employee with **S.R.Construction as Junior site engineer** in construction department from **20/01/2022 to 20/03/2022** as per the personal file and company's employment record. During his employment, we found Mr. Pandurang Kishanrao Bhave to be a professional, knowledgeable and result oriented with theoretical and practical understanding of work requirements. He has successfully completed jobs in Structure related training programmers administered by the training department of the company. He has a friendly, outgoing personality, very good sense of humor and works well as an individual or member of a team as required by the management, Overall, Mr.Pandurang Kishanrao Bhave performing his duties and responsibilities cheerfully with attention to detail at all times. With his enthusiasm to work, learn and progress, I am certain that he would make a great employee to any enterprise.

Please feel free to contact us if you have specific questions regarding his employment. On behalf of the company, I take this opportunity to wish Mr. Pandurang Kishanrao Bhave all the very best in his future career endeavors.



Shraddha Associates

Planning and construction

*[Handwritten Signature]*  
10/5/2022





# OMKAR CONSTRUCTIONS

R.C.C. & Construction Work will done at Reasonable Rate.

Opposite Panchayat Samiti , Bajrang Ali , Bhor , District :- Pune 412206

Email : [sameermore80@gmail.com](mailto:sameermore80@gmail.com)

Mo. : 9823337749

Date : 13/04/2022

## TO WHOM IT MAY CONCERN

This is to certify that Ms. Kale Rutuja student of RDTG Dhangwadi , pursuing T.E. Civil has successfully completed field internship of winter vacation at OMKAR CONSTRUCTIONS, Bhor. Dated from 15/01/2022 to 10/04/2022 under the guidance of Er. More Sameer .

During the period of training ,she was found punctual and she is sincere about gaining the field knowledge.

OMKAR CONSTRUCTIONS



5

OMKAR CONSTRUCTIONS  

# CERTIFICATE



This is to certify that **Mr. MAHANGARE PRATIK SUDAM AND KOLI MAYURESH SANJAY** student of Rajgad Dnyanpeeth Technical Campus, Dhangawadi. This students has completed his Industrial Training in **OMKAR BUILDING AND MATERIAL SUPPLIERS** during 15 JAN 2022 To 10 APRIL 2022. During academic year 2021-2022, as partial fulfilment of the Degree (Civil Engineering) course.

  
Signature of Manager



# CERTIFICATE

This is to certify that **Mr. MAHANGARE PRATIK SUDAM AND KOLI MAYURESH SANJAY** student of Rajgad Dnyanpeeth Technical Campus, Dhangawadi. This students has completed his Industrial Training in **OMKAR BUILDING AND MATERIAL SUPPLIERS** during 15 JAN 2022 To 10 APRIL 2022. During academic year 2021-2022, as partial fulfilment of the Degree (Civil Engineering) course.



Signature of Manager





# Internship certificate

(O) 020-27247112  
(R) 020-27657156

27/419, Opp. Swimming Pool, Nigdi Pradhikaran, Pune - 411 044  
email : anuragconstructions@gmail.com



**ANURAG  
CONSTRUCTIONS**

## INTERNSHIP COMPLETION CERTIFICATE

April 12, 2022

TO WHOME IT MAY CONCERN

THIS IS TO CERTIFY THAT MR. MANOJ ARVIND KUKADE PURSUING DEGREE (CIVIL ENGINEERING) FROM RAJGAD DNYANPEETH TECHNICAL CAMPUS, PUNE-411041. HAS SUCCESSFULLY COMPLETED INTERNSHIP PROGRAM FOR 1 MONTH [FROM 15<sup>TH</sup> JAN 2022 TO 10<sup>TH</sup> APRIL 2022] ONLY WEEKEND WORKING AT ANURAG CONSTRUCTIONS NIGDI. PUNE.

DURING THE PERIOD OF THIS INTERNSHIP WE FOUND HIM TO BE VERY SINCERE, CURIOUS, ANALYTICAL, HARDWORKING, & RESULT ORIENTED.

HIS ASSOCIATION WITH US WAS VERY FRUITFUL AND WE WISH HIM ALL THE BEST IN HIS FUTURE ENDEAVORS.

For Anurag Constructions

Prop. 

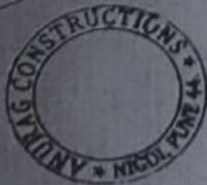



62

Date : 11 / 04 / 2022

INTERNSHIP COMPLETION CERTIFICATE

TO WHOM IT MAY CONCERN

THIS IS TO CERTIFY THAT MR VAIBHAV DILIP LOKHANDE PURSUING DEGREE (CIVIL ENGINEERING) FROM RAJGAD DNYANDEEP TECHNICAL CAMPUS, PUNE 412206. HAS SUCCESSFULLY COMPLETED THE INTERNSHIP PROGRAM FOR 1 MONTH (FROM 15 TH JAN 2022 TO 10TH APRIL 2022) ONLY SATURDAY AND SUNDAY WORKING AT KUNJIR BIOENERGY INDIA LLP.

DURING THE PERIOD OF THIS INTERNSHIP WE FOUND HIM VERY SINCERE, CURIOUS, ANALYTICAL HARD WORKING AND RESULT ORIENTED.

THIS ASSOCIATION WITH US WAS VERY FRUITFUL AND WE WISH HIM ALL THE BEST IN HIS FUTURE ENDEAVORS

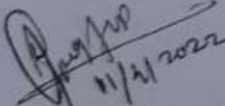
  
11/4/2022

ER AKSHAY G. JAGTAP.

(PROJECT HEAD-CIVIL)

KBILLP



Corporate Office  
S.No.52/1/99, Shriram Housing Society "KUNJIR HOUSE" Behind Poona Merchant Bank,  
Pune nagar Road, Chandannagar, Kharadi, Pune - 411 014.

Factory  
Gat No. 47/1, 47/2, 48 to 53(P), At Mirwadi, Post Dahitane, Tal. Daund, Dist. - Pune-412207.

9231137467 | 9231137467 | 9231137467

Mob.: 9921600011 | Email: kbillp2016@gmail.com |



Date : 11 / 04 / 2022

INTERNSHIP COMPLETION CERTIFICATE

TO WHOM IT MAY CONCERN

THIS IS TO CERTIFY THAT MR ADITYA NANDKUMAR SHINDE PURSUING DEGREE (CIVIL ENGINEERING) FROM RAJGAD DNYANDEEP TECHNICAL CAMPUS, PUNE 412206. HAS SUCCESSFULLY COMPLETED THE INTERNSHIP PROGRAM FOR 1 MONTH (FROM 15 TH JAN 2022 TO 10TH APRIL 2022) ONLY SATURDAY AND SUNDAY WORKING AT KUNJIR BIOENERGY INDIA LLP.

DURING THE PERIOD OF THIS INTERNSHIP WE FOUND HIM VERY SINCERE, CURIOUS, ANALYTICAL HARD WORKING AND RESULT ORIENTED.

THIS ASSOCIATION WITH US WAS VERY FRUITFUL AND WE WISH HIM ALL THE BEST IN HIS FUTURE ENDEAVORS

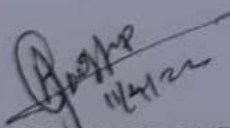
  
ER AKSHAY G. JAGTAP.  
(PROJECT HEAD-CIVIL)

KBILLP



Corporate Office  
S No.52/1/99, Shriram Housing Society 'KUNJIR HOUSE' Behind Poona Merchant Bank,  
Pune nagar Road, Chandannagar, Kharadi, Pune - 411 014.

Factory -  
Gat No. 47/1, 47/2, 48 to 53(P), At Mirwadi, Post Dahitane, Tal. Daund, Dist.: Pune-412207

GSTIN : 27AAQFK7285K12Z | PAN NO. AAQFK7285B

Mob.: 9921600011 | Email: kbillp2016@gmail.com |



# AKAR CONSTRUCTION

SINCE 1993

A/p New Colony, Shirwal, Tal. Khandala Dist., Satara.



Date: 10/04/2022

## INTERNSHIP COMPLETION CERTIFICATE

### To whom-so-ever it may concern

Project Name: K & K Heights

This is to certify that **Mr. Shreeraj Vijay Adsul** student of Civil Engineering [3<sup>rd</sup> Year] from Shri. Chhatrapati ShivajiRaje College of Engineering Dhangawadi, Pune-412206 has successfully completed Internship Program for 3 months dated from 15/01/2022 to 10/04/2022 at Ongoing project of **AKAR CONSTRUCTION** Shirwal.

During this above tenure we found him to be regular, honest & diligent in duties & responsibilities. His association with us was very truthful & we wish him all the success for his future endeavours.

*Kunjeeb*  
AKAR CONSTRUCTION  
Kazi A. A. Shirwal



+91 96733 82766 / +91 74999 74890

[akarconstructions1993@gmail.com](mailto:akarconstructions1993@gmail.com)



# CERTIFICATE



**AKAR CONSTRUCTION**  
BUILDING SINCE 1993

A/p New Colony, Shirwal, Tal. Khandala Dist. Satara.

Date: 30/05/2022

## TO WHOM IT MAY CONCERN

This is to certify that Ms. Bhandalkar Puja Mansing student of RDTC Dhangwadi, pursuing T.E. Civil has successfully completed field internship of winter vacation at Akar Constructions, Shirwal. Dated from 15/01/2022 to 10/04/2022 under the guidance of Er. ARSHAD KAZI.

During the period of training, She was found punctual and she is sincere about gaining the field knowledge.

**AKAR CONSTRUCTION**  
Kazi A. A. Sarwal

+91 96733 83766 / +91 74999 74890

[akarconstructions1993@gmail.com](mailto:akarconstructions1993@gmail.com)



# CERTIFICATE



**AKAR CONSTRUCTION**  
BUILDING SINCE 1993

A/p New Colony, Shirwal, Tal. Khandala Dist., Satara.

Date: 30/05/2022

## TO WHOM IT MAY CONCERN

This is to certify that Ms. Pawar Sayali Ravindra student of RDTG Dhangwadi, pursuing T.E. Civil has successfully completed field internship of winter vacation at Akar Constructions, Shirwal. Dated from 15/01/2022 to 10/04/2022 under the guidance of Er. ARSHAD KAZI.

During the period of training, She was found punctual and she is sincere about gaining the field knowledge.

**AKAR CONSTRUCTION**  
Kazi A. A. Shirwal

+91 98733 83766 / +91 74999 74890  
**akarconstructions1993@gmail.com**





# AKAR CONSTRUCTION

SINCE 1993

A/p New Colony, Shirwal, Tal. Khandala Dist. ,Satara.

Date: 10/04/2022

## INTERNSHIP COMPLETION CERTIFICATE

To whom-so-ever it may concern

Project Name: K & K Heights

This is to certify that **Mr. Mujeeb Arshad Kazi** student of Civil Engineering [ 3<sup>rd</sup> Year] from Shri. Chhatrapati ShivajiRaje College of Engineering Dhangawadi, Pune-412206 has successfully completed Internship Program for 3 months dated from 15/01/2022 to 10/04/2022 at Ongoing project of **AKAR CONSTRUCTION** Shirwal.

During this above tenure we found him to be regular,honest & dilgent in duties & responsibilities. His association with us was very truthful & we wish him all the success for his future endeavours.

*Mujeeb*

AKAR CONSTRUCTION  
Kazi A. A. Shirwal



+91 96733 82766 / +91 74999 74890

[akarconstructions1993@gmail.com](mailto:akarconstructions1993@gmail.com)



# CERTIFICATE

This is To Certify that **MR. SAURABH KSHIRSAGAR** student of Rajgad Dnyanpeeth Technical Campus, Dhangawadi. This student Permanent Registration Number -72033273H has completed his Industrial Training during 15 JAN 2022 To 25 FEB 2022. During academic year 2021-2022, as partial fulfilment of the Degree (Civil Engineering ) course.



**Sahyadri Construction Company**

Sahyadri Earth Complex, First Floor, Near Laxmi Temple,  
Vishrambag-Kupwad Road, Sangli - 416416, Maharashtra.

Tel: 0233-2302099, 2300396

Email: sahyadricon@gmail.com, sahyadricon@rediffmail.com



**INTERNSHIP CERTIFICATE**

DATE:10/04/2022

TO  
WHOMEITMAYCONCERN

PROJECT NAME:INDIAN RAILWAY DOUBBLE LINE WORK.

THIS IS TO CERTIFY THAT MR.ROHIT RAJENDRA SURYAWANSHI PURSUING DEGREE (CIVIL ENGINEERING) FROM RAJGAD DNYANPEETH TECHNICAL CAMPUS, PUNE-411041. HAS SUCCESSFULLY COMPLETED INTERNSHIP PROGRAM FOR 1 MONTH [FROM 15<sup>TH</sup> JAN 2022 TO 10<sup>TH</sup> APRIL 2022] AT SAHYADRI CONSTRUCTIONS SANGLI.

DURING THE PERIOD OF THIS INTERNSHIP WE FOUND HIM TO BE VERRY SINCERE, CURIOUS, ANALYTICAL, HARDWORKING, & RESULT ORIENTED.

HIS ASSOCIATION WITH US WAS VERY FRUITFUL AND WE WISH HIM ALL THEBEST INHIS FUTURE ENDEAVORS.

Sahyadri Construction

*J*  
Proprietor



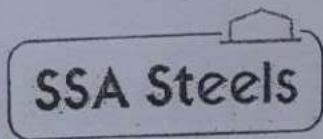

Its all about Pre-Engineering Buildings

SSA Steels.  
Plot No. 72/2, 711, Ambegaon Kh,  
Pune - 411046.  
Ph: +91 9561145007.  
Email: info@ssasteels.in

DATE: 12/04/2022

## INTERNSHIP LETTER

This is to certify that **Mr. Chavan Aniket Keshav** has undergone 1 Month Internship under **Mr. A. N. BATHE** from 15/01/2022 to 10/04/2022. He has successfully completed training in our project "**CONSTRUCTION OF RESIDENTIAL BUILDING**". During training period he took keen interest in assigned work. We wish his all success in his academic endeavors & life.

Best Regards,

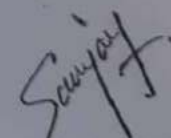

  
Sanjay Patil  
**SSA STEELS**  
9561145007.  
[sanjay@ssasteels.com](mailto:sanjay@ssasteels.com)



**SSA Steels**

Its all about Pre-Engineering Buildings

SSA Steels.  
Plot No. 79/2, 711, Ambegaon Kh,  
Pune - 411046.  
Ph: +91 9561145007.  
Email: info@ssasteels.in

DATE: 12/04/2022

## INTERNSHIP LETTER

This is to certify that **Mr. Saurabh Maruti Bhilare** has undergone 1 Month Internship under **Mr. A. N. BATHE** from 15/01/2022 to 10/04/2022. He has successfully completed training in our project "**CONSTRUCTION OF RESIDENTIAL BUILDING**" During training period he took keen interest in assigned work. We wish his all success in his academic endeavors & life.

Best Regards,



*Sanjay Patil*

Sanjay Patil

**SSA STEELS**

9561145007.

[sanjay@ssasteels.com](mailto:sanjay@ssasteels.com)

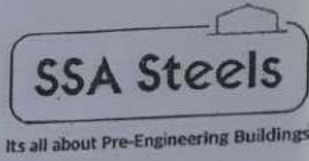

SSA Steels.  
Plot No. 72/2, 711, Ambegaon Kh,  
Pune - 411046.  
Ph: +91 9561145007.  
Email: info@ssasteels.in

DATE: 12/04/2022

## INTERNSHIP LETTER

This is to certify that Mr. Chaudhari Vivek Rajendra has undergone 1 Month Internship under Mr. A. N. BATHE from 15/01/2022 to 10/04/2022. He has successfully completed training in our project "CONSTRUCTION OF RESIDENTIAL BUILDING". During training period he took keen interest in assigned work. We wish his all success in his academic endeavors & life.

Best Regards,



Sanjay Patil

**SSA STEELS**

9561145007.

[sanjay@ssasteels.com](mailto:sanjay@ssasteels.com)





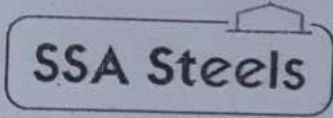

Its all about Pre-Engineering Buildings

SSA Steels.  
Plot No. 72/2, 711, Ambegaon Kh,  
Pune - 411046.  
Ph: +91 9561145007.  
Email: info@ssasteels.in

DATE: 12/04/2022

## INTERNSHIP LETTER

This is to certify that **Mr. Bandal Nikhil Bharat** has undergone 1 Month Internship under **Mr. A. N. BATHE** from 15/01/2022 to 10/04/2022. He has successfully completed training in our project "**CONSTRUCTION OF RESIDENTIAL BUILDING**". During training period he took keen interest in assigned work. We wish his all success in his academic endeavors & life.

Best Regards,



Sanjay Patil

**SSA STEELS**

9561145007.

[sanjay@ssasteels.com](mailto:sanjay@ssasteels.com)



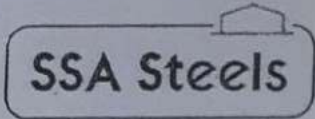

Its all about Pre-Engineering Buildings

SSA Steels.  
Plot No. 72/2, 711, Ambegaon Kh,  
Pune - 411046.  
Ph: +91 9561145007.  
Email: [Info@ssasteels.in](mailto:Info@ssasteels.in)

DATE: 12/04/2022

## INTERNSHIP LETTER

This is to certify that **Mr. Barge Abhijeet Sunil** has undergone 1 Month Internship under **Mr. A. N. BATHE** from 15/01/2022 to 10/04/2022. He has successfully completed training in our project "**CONSTRUCTION OF RESIDENTIAL BUILDING**". During training period he took keen interest in assigned work. We wish his all success in his academic endeavors & life.

Best Regards,



  
Sanjay Patil  
**SSA STEELS**  
9561145007.  
[sanjay@ssasteels.com](mailto:sanjay@ssasteels.com)



अनंतराव थोपटे  
(मा. मंत्री महाराष्ट्र राज्य)  
संस्थापक - रियलक

संग्रामदादा थोपटे  
चेअरमन (आमदार )



राजगड

67

सहकारी साखर कारखाना लि.,  
अनंतनगर - निगडे, ता. भोर, जि. पुणे - ४१२२०५  
फोन नं. : (०२११३) २०२२०२, २०२२०४  
मोबा नं. : ९८५०६२८८३६/९९२२४१४२३९  
फॅक्स : (०२११३) २८२४०५  
तार : " राजसुगर "भोर  
इमेल : rajgadsugar\_bhor@rediffmail.com  
rajgadsugarbhor@gmail.com

Date :- 12-04-2022

**Certificate of Training**  
**TO WHOM IT MAY CONCERN**

This is to certified that,

**Mr. Gade Rohan Rajendra**

Of Shri Chatrapati Shivajiraje College of Engineering, Dhangawadi, Tal. Bhor, Dist- Pune

Branch-Civil Engineering have successfully completed 1 month (15/01/2022 to 10/04/2022) training in our company.

During the training, student have closely worked as part of our team.

We wish them good luck for all future endower & look forward to work with them in the near future

Regards,

Managing director

Rajgad sahkari sakhar kharkhana Ltd.

Anantnagar Nigade, Tal. Bhor, Dist Pune



अनंतराव थोपटे  
(मा. मंत्री महाराष्ट्र राज्य)  
संस्थापक - संचालक

संग्रामदादा थोपटे  
चेअरमन (आमदार )



# राजगाड

सहकारी साखर कारखाना लि.,  
अनंतनगर - निगडे, ता. भोर, जि. पुणे - ४१२२०५  
फोन नं. : (०२११३) २०२२०२, २०२२०४  
मोबा नं. : ९८५०६२८८३६/९९२२४९४२३९  
फॅक्स : (०२११३) २८३४०५  
तार : " राजशुगर " भोर  
इमेल : rajgadsugar \_ bhor@rediffmail. com  
rajgadsugarbhor@gmail.com

Date :- 12-04-2022

## *Certificate of Training*

### **TO WHOM IT MAY CONCERN**

This is to certified that,

**Mr. Devkate Sagar Sidhu**

Of Shri Chatrapati Shivajiraje College of Engineering, Dhangawadi, Tal. Bhor, Dist- Pune

Branch-Civil Engineering have successfully completed 1 month (15/01/2022 to 10/04/2022) training in our company.

During the training, student have closely worked as part of our team.

We wish them good luck for all future endower & look forward to work with them in the near future

Regards,

Managing director

Rajgad sahkari sakhar kharkhana Ltd.

Anantnagar Nigade, Tal. Bhor, Dist Pune



अनंतराव थोपटे  
(मा. मंत्री महाराष्ट्र राज्य)  
संस्थापक -संघालक

संग्रामदादा थोपटे  
चेअरमन (आमदार )



**राजगड**

सहकारी साखर कारखाना लि.,  
अनंतनगर - निगडे, ता. भोर, जि. पुणे - ४१२२०५  
फोन नं. : (०२११३) २०२२०२, २०२२०४  
मोबा नं. : ९८५०६२८८३६/९९२२४१४२३९  
फॅक्स : (०२११३) २८२४०५  
तार : "राजशुगर" भोर  
इमेल : rajgadsugar\_bhor@rediffmail.com  
rajgadsugarbhor@gmail.com

Date :- 12-04-2022

***Certificate of Training***

**TO WHOM IT MAY CONCERN**

This is to certified that,

**Mr. Chikane Jay Dattatray**

Of Shri Chatrapati Shivajiraje College of Engineering, Dhangawadi, Tal. Bhor, Dist- Pune

Branch-Civil Engineering have successfully completed 1 month (15/01/2022 to 10/04/2022) training in our company.

During the training, student have closely worked as part of our team.

We wish them good luck for all future endower & look forward to work with them in the near future

Regards,

Managing director

Rajgad sahkari sakhar kharkhana Ltd.

Anantnagar Nigade, Tal. Bhor, Dist Pune



अनंतराव थोपटे  
(मा. मंत्री महाराष्ट्र राज्य)  
संस्थापक -संयोजक

संग्रामदादा थोपटे  
चेअरमन (आमदार )



# राजगड

सहकारी साखर कारखाना लि.,  
अनंतनगर - निगडे, ता. भोर, जि. पुणे - ४१२२०५  
फोन नं. : (०२११३) २०२२०२, २०२२०४  
मोबा नं. : ९८५०६२८८३६/९९२२४१४२३९  
फॅक्स : (०२११३) २८२४०५  
तार : " राजशुगर "भोर  
इमेल : rajgadsugar\_bhor@rediffmail.com  
rajgadsugarbhor@gmail.com

Date :- 12-04-2022

## *Certificate of Training*

### **TO WHOM IT MAY CONCERN**

This is to certified that,

**Mr. Chavan Kiran Yuvraj**

Of Shri Chatrapati Shivajiraje College of Engineering, Dhangawadi, Tal. Bhor, Dist- Pune

Branch-Civil Engineering have successfully completed 1 month (15/01/2022 to 10/04/2022) training in our company.

During the training, student have closely worked as part of our team.

We wish them good luck for all future endower & look forward to work with them in the near future

Regards,

Managing director

Rajgad sahkari sakhar kharkhana Ltd.

Anantnagar Nigade, Tal. Bhor, Dist Pune



68



M/s.

**SARVESH CONSTRUCTION COMPANY**

ENGINEERS & GOVT. CONTRACTORS

A. A. Pawar

H.O. :At Padmavati. Post - Bhuinj , Tai Wai, Dist Satara. ☎ : (02167) 285371

Branch Office: "BASERA" ITI Road, Near P & T Col ony, Dist. ShivajiNagar, Dist Ratnagiri ☎ : 02352)225521

Date: 15/04/2022

**TO WHOM IT MAY CONCERN**

This is to certify that **Mr. GUJAR AMOL RAJENDRA**, a student of Department of Civil Engineering, Rajgad Dnyanpeeth Technical Campus, Shri Chhatrapati Shivajiraje College of Engineering, Dhangawadi, Pune has successfully completed 1 Month (From 15/01/2022 to 10/04/2022) Internship program on our project site. During the period of her internship program with us she was found punctual, hardworking and inquisitive.

We wish her every success in life.

Sarvesh Construction Company

Proprietor

(Authorized Signature)





M/s.

**SARVESH CONSTRUCTION COMPANY**

ENGINEERS & GOVT. CONTRACTORS

A. A. Pawar

H.O. :At Padmavati. Post - Bhuinj , Tai Wai, Dist Satara. ☎ : (02167) 285371

Branch Office: "BASERA" ITI Road, Near P & T Col ony, Dist. Shivajinagar, Dist Ratnagiri ☎ : 02352)225521

Date: 15/04/2022

**TO WHOM IT MAY CONCERN**

This is to certify that **Mr. Jadhav Ajit Sanjay**, a student of Department of Civil Engineering, Rajgad Dnyanpeeth Technical Campus, Shri Chhatrapati Shivajiraje College of Engineering, Dhangawadi, Pune has successfully completed 1 Month (From 15/01/2022 to 10/04/2022) Internship program on our project site. During the period of her internship program with us she was found punctual, hardworking and inquisitive.

We wish her every success in life.

Sarvesh Construction Company

Proprietor

(Authorized Signature)







M/s.

**SARVESH CONSTRUCTION COMPANY**

ENGINEERS & GOVT. CONTRACTORS

A. A. Pawar

H.O. :At Padmavati. Post - Bhujinj , Tai Wai, Dist Satara. ☎ : (02167) 285371

Branch Office: "BASERA" ITI Road, Near P & T Colony, Dist. Shivajinagar, Dist Ratnagiri ☎ : 02352)225521

Date: 15/04/2022

**TO WHOM IT MAY CONCERN**

This is to certify that **Mr. Jadhav Shubham Navanath**, a student of Department of Civil Engineering, Rajgad Dnyanpeeth Technical Campus, Shri Chhatrapati Shivajiraje College of Engineering, Dhangawadi, Pune has successfully completed 1 Month (From 15/01/2022 to 10/04/2022) Internship program on our project site. During the period of her internship program with us she was found punctual, hardworking and inquisitive.

We wish her every success in life.

Sarvesh Construction Company

Proprietor

(Authorized Signature)





M/s.

**SARVESH CONSTRUCTION COMPANY**

ENGINEERS & GOVT. CONTRACTORS

A. A. Pawar

H.O. :At Padmavati. Post - Bhuinj , Tai Wai, Dist Satara. ☎ : (02167) 285371

Branch Office: "BASERA" ITI Road, Near P & T Col ony, Dist. ShivajiNagar, Dist Ratnagiri ☎ : 02352)225521

Date: 15/04/2022

**TO WHOM IT MAY CONCERN**

This is to certify that Mr. Kadam Pratik Satish, a student of Department of Civil Engineering, Rajgad Dnyanpeeth Technical Campus, Shri Chhatrapati Shivajiraje College of Engineering, Dhangawadi, Pune has successfully completed 1 Month (From 15/01/2022 to 10/04/2022) Internship program on our project site. During the period of her internship program with us she was found punctual, hardworking and inquisitive.

We wish her every success in life.

Sarvesh Construction Company

Proprietor

(Authorized Signature)





M/s.

**SARVESH CONSTRUCTION COMPANY**

ENGINEERS & GOVT. CONTRACTORS

A. A. Pawar

H.O. :At Padmavati. Post - Bhujin , Tai Wai, Dist Satara. ☎ : (02167) 285371

Branch Office: "BASERA" ITI Road, Near P & T Col ony, Dist. ShivajiNagar, Dist Ratnagiri ☎ : 02352)225521

Date: 15/04/2022

**TO WHOM IT MAY CONCERN**

This is to certify that **Mr. Karale Pravin Sudhir**, a student of Department of Civil Engineering, Rajgad Dnyanpeeth Technical Campus, Shri Chhatrapati Shivajiraje College of Engineering, Dhangawadi, Pune has successfully completed 1 Month (From 15/01/2022 to 10/04/2022) Internship program on our project site. During the period of her internship program with us she was found punctual, hardworking and inquisitive.

We wish her every success in life.

Sarvesh Construction Company

Proprietor

(Authorized Signature)





M/s.

**SARVESH CONSTRUCTION COMPANY**

ENGINEERS & GOVT. CONTRACTORS

A. A. Pawar

H.O. :At Padmavati. Post - Bhujinj , Tai Wai, Dist Satara. ☎ : (02167) 285371

Branch Office: "BASERA" ITI Road, Near P & T Col ony, Dist. ShivajiNagar, Dist Ratnagiri ☎ : 02352)225521

Date: 15/04/2022

**TO WHOM IT MAY CONCERN**

This is to certify that **Mr. Katta Sachin Sanju**, a student of Department of Civil Engineering, Rajgad Dnyanpeeth Technical Campus, Shri Chhatrapati Shivajiraje College of Engineering, Dhangawadi, Pune has successfully completed 1 Month (From 15/01/2022 to 10/04/2022) Internship program on our project site. During the period of her internship program with us she was found punctual, hardworking and inquisitive.

We wish her every success in life.

Sarvesh Construction Company

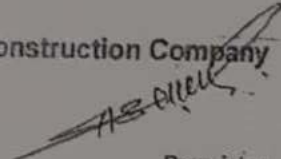
  
Proprietor

(Authorized Signature)





# ANANT DUDH PVT LTD.



DAIRY : -

Gat No. 263, A/p. Kikavi, Tal, Bhor, Dist. Pune, Pin : 412206.  
Tele Fax No. : (02113) 282383, Phone : 202242 - E-mail-anant\_dudh@yahoo.co.in  
Website:www.anantdudh.tradeindia.com

PUNE OFFICE : - Datta Digambar Sahakar Vahatuk Kamgar Sanstha Ltd. Building, Near Bharati Vidyapeeth Get,  
Pune - Satara Road, Katraj, Pune - 411046.

Date :- 13-04-2022

## *Certificate of Training*

### To Whomsoever It May Concern

This is to certified that,

**Mr. Kavachat Dattatraya Abhiman (TE- Civil)**

Of Shri Chatrapati Shivajiraje College of Engineering, Dhangawadi, Tal. Bhor, Dist- Pune

Branch-Civil Engineering have successfully completed 1 month (15/01/2022 to 10/04/2022) training in our company.

During the training, student have closely worked as part of our team.

We wish them good luck for all future endower & look forward to work with them in the near future

With Regards,





# ANANT DUDDH PVT LTD.

DAIRY :-

Gat No, 263, A/p. Kikavi, Tal. Bhor, Dist. Pune, Pin : 412206.  
Tele Fax No. : (02113) 282383, Phone : 202242 - E-mail-anant\_duddh@yahoo.co.in  
Website:www.anantduddh.tradeindia.com

PUNE OFFICE :- Datta Digambar Sahakari Vahatuk Kamgar Sanatha Ltd. Building, Near Bharati Vidyapeeth Get,  
Pune - Satara Road, Katraj, Pune - 411046.

Date :- 13-04-2022

## *Certificate of Training*

### To Whomsoever It May Concern

This is to certified that,

**Mr. Kazi Yasin Yunus (TE- Civil)**

Of Shri Chatrapati Shivajiraje College of Engineering, Dhangawadi, Tal. Bhor, Dist- Pune

Branch-Civil Engineering have successfully completed 1 month (15/01/2022 to 10/04/2022) training in our company.

During the training, student have closely worked as part of our team.

We wish them good luck for all future endower & look forward to work with them in the near future

With Regards,





# ANANT DUDH PVT LTD.

DAIRY :-

Gat No. 263, A/p. Kikavi, Tal. Bhor, Dist. Pune, Pin : 412206  
Tele Fax No. : (02113) 282383, Phone : 202242 - E-mail-anant\_dudh@yahoo.co.in  
Website: www.anantdudh.tradeindia.com

PUNE OFFICE :- Datta Digambar Sahakar Vahatuk Kamgar Sanstha Ltd. Building, Near Bharati Vidyapeeth Get,  
Pune - Satara Road, Katraj, Pune - 411046.

Date :- 13-04-2022

## *Certificate of Training*

### To Whomsoever It May Concern

This is to certified that,

**Mr. Mane Amit Jagdish (TE- Civil)**

Of Shri Chatrapati Shivajiraje College of Engineering, Dhangawadi, Tal. Bhor, Dist- Pune

Branch-Civil Engineering have successfully completed 1 month (15/01/2022 to 10/04/2022) training in our company.

During the training, student have closely worked as part of our team.

We wish them good luck for all future endower & look forward to work with them in the near future

With Regards,





# ANANT DUDH PVT LTD.

DAIRY :-

Gat No, 263, A/p. Kikavi, Tal. Bhor, Dist. Pune, Pin : 412206.  
Tele Fax No. : (02113) 282383, Phone : 202242 - E-mail-anant\_dudh@yahoo.co.in  
Website:www.anantdudh.tradeindia.com

PUNE OFFICE :- Delta Digambar Sahakar Vahatuk Kamgar Senstha Ltd. Building, Near Bharati Vidyapeeth Ge  
Pune - Satara Road, Kalraj, Pune - 411046.

Date :- 13-04-2022

## *Certificate of Training*

### To Whomsoever It May Concern

This is to certified that,

**Mr. Mane Navanath Somanna (TE- Civil)**

Of Shri Chatrapati Shivajiraje College of Engineering, Dhangawadi, Tal. Bhor, Dist- Pune

Branch-Civil Engineering have successfully completed 1 month (15/01/2022 to 10/04/2022) training in our company.

During the training, student have closely worked as part of our team.

We wish them good luck for all future endower & look forward to work with them in the near future

With Regards,







# ANANT DUDH PVT LTD.

DAIRY :-

Gat No. 263, A/p. Kikavi, Tal. Bhor, Dist. Pune, Pin : 412206.  
Tele Fax No. : (02113) 282383, Phone : 202242 - E-mail-anant\_dudh@yahoo.co.in  
Website:www.anantdudh.tradeindia.com

PUNE OFFICE :- Datta Digambar Sahakari Vahatuk Kamgar Sanstha Ltd. Building, Near Bharati Vidyapeeth Get,  
Pune - Satara Road, Kalraj, Pune - 411046.

Date :- 13-04-2022

## *Certificate of Training*

### To Whomsoever It May Concern

This is to certified that,

**Mr. Navghane Sourabh Sopan (TE- Civil)**

Of Shri Chatrapati Shivajiraje College of Engineering, Dhangawadi, Tal. Bhor, Dist- Pune

Branch-Civil Engineering have successfully completed 1 month (15/01/2022 to 10/04/2022) training in our company.

During the training, student have closely worked as part of our team.

We wish them good luck for all future endower & look forward to work with them in the near future

With Regards,





# ANANT DUDH PVT LTD.

DAIRY :-

Gat No, 263, A/p. Kikavi, Tal, Bhor, Dist. Pune, Pin : 412206.  
Tele Fax No. : (02113)282383, Phone : 202242 - E-mail-anant\_dudh@yahoo.co.in  
Website:www.anantdudh.tradeindia.com

PUNE OFFICE :- Datta Digambar Sahakar Vahatuk Kamgar Sanstha Ltd. Building, Near Bharati Vidyapeeth Get,  
Pune - Satara Road, Kalraj, Pune - 411046.

Date :-13-04-2022

## *Certificate of Training*

### To Whomsoever It May Concern

This is to certified that,

**Mr. Nigade Sandesh Suresh (TE- Civil)**

Of Shri Chatrapati Shivajiraje College of Engineering, Dhangawadi, Tal. Bhor, Dist- Pune

Branch-Civil Engineering have successfully completed 1 month (15/01/2022 to 10/04/2022) training in our company.

During the training, student have closely worked as part of our team.

We wish them good luck for all future endower & look forward to work with them in the near future

With Regards,





**SHRINATH DEVELOPERS** B. E Civil, M. E STRUCTURE

Civil Engineers and Govt. Contractors

At Post-Gunand Tal-Bhor Dist-Pune

Date- 12/04/2022

To,

The Principal/H. O.D.

Rajgad Dnyanpeeth's,

Shri Chhatrapati Shivajiraje College Of Engineering,

Dhangawadi, Tal-Bhor, Dist -Pune.

Respected Sir,

This is certify that **Mr. PAWAR VISHAL SANJAY** has undergone **1Month Internship** Under, **Mr. ABHIJEET FARGADE** from **15 Jan 2022 to 10 April 2022**. He has successfully Completed Training in our project "**CONSTRUCTION OF RESIDENTIAL BUILDING**".

During training period he took keep interest in assigned work. During the training period of internship with us he was found Punctual, Hardworking, inquisitive. We wish him all success in academic endeavors and life.

Best Regards,

*A. J. Fargade*  
**Shrinath Developers**  
Proprietor





**SHRINATH DEVELOPERS** B. E Civil, M. E STRUCTURE

Civil Engineers and Govt. Contractors

At Post-Gunand Tal-Bhor Dist-Pune

Date- 12/04/2022

To,

The Principal/H. O.D.

Rajgad Dnyanpeeth's,

Shri Chhatrapati Shivajiraje College Of Engineering,

Dhangawadi, Tal-Bhor, Dist -Pune.

Respected Sir,

This is certify that **Mr. PAYGHUDE SUBHAM SANJAY** has undergone **1 Month Internship** Under, **Mr. ABHIJEET FARGADE** from **15 Jan 2022 to 10 April 2022**. He has successfully Completed Training in our project "**CONSTRUCTION OF RESIDENTIAL BUILDING**". During training period he took keep interest in assigned work. During the training period of internship with us he was found Punctual, Hardworking, inquisitive. We wish him all success in academic endeavors and life.

- Best Regards,

*Abhijeet*  
**Shrinath Developers**

Proprietor





**SHRINATH DEVELOPERS** B. E Civil, M. E STRUCTURE

Civil Engineers and Govt. Contractors

At Post-Gunand Tal-Bhor Dist-Pune

Date- 12/04/2022

To,

The Principal/H. O.D.  
Rajgad Dnyanpeeth's,  
Shri Chhatrapati Shivajiraje College Of Engineering,  
Dhangawadi, Tal-Bhor, Dist -Pune.

Respected Sir,

This is certify that **Mr. POWER NAMDEV TIMAANA** has undergone **1Month Internship** Under, **Mr. ABHIJEET FARGADE** from **15 Jan 2022 to 10 April 2022**. He has successfully Completed Training in our project "**CONSTRUCTION OF RESIDENTIAL BUILDING**". During training period he took keep interest in assigned work. During the training period of internship with us he was found Punctual, Hardworking, inquisitive. We wish him all success in academic endeavors and life.

Best Regards,

*Aigade*  
**Shrinath Developers**

Proprietor





**SHRINATH DEVELOPERS** B. E Civil, M. E STRUCTURE

Civil Engineers and Govt. Contractors

At Post-Gunand Tal-Bhor Dist-Pune

Date- 12/04/2022

To,

The Principal/H.O.D.

Rajgad Dnyanpeeth's,

Shri Chhatrapati Shivajiraje College Of Engineering,

Dhangawadi, Tal-Bhor, Dist -Pune.

Respected Sir,

This is certify that Ms. SHINDE SHIVANI ASHOK has undergone 1Month Internship Under, Mr. ABHIJEET FARGADE from 15 Jan 2022 to 10 April 2022. He has successfully Completed Training in our project "CONSTRUCTION OF RESIDENTIAL BUILDING".

During training period he took keep interest in assigned work. During the training period of internship with us he was found Punctual, Hardworking, inquisitive. We wish him all success in academic endeavors and life.

Best Regards,

*Aljale*  
Shrinath Developers

Proprietor





**SHRINATH DEVELOPERS** B. E Civil, M. E STRUCTURE

Civil Engineers and Govt. Contractors

At Post-Gunand Tal-Bhor Dist-Pune

Date- 12/04/2022

To,

The Principal/H. O.D.

Rajgad Dnyanpeeth's,

Shri Chhatrapati Shivajiraje College Of Engineering,

Dhangawadi, Tal-Bhor, Dist -Pune.

Respected Sir,

This is certify that **Mr. KARCHUNDE RAMESH SUNDERRAO** has undergone **1Month** Internship Under, **Mr. ABHIJEET FARGADE** from **15 Jan 2022 to 10 April 2022**. He has successfully Completed Training in our project "**CONSTRUCTION OF RESIDENTIAL BUILDING**". During training period he took keep interest in assigned work. During the training period of internship with us he was found Punctual, Hardworking, inquisitive. We wish him all success in academic endeavors and life.

Best Regards,

*Abhishek*  
Shrinath Developers

Proprietor





**SHRINATH DEVELOPERS** B. E Civil, M. E STRUCTURE

Civil Engineers and Govt. Contractors

At Post-Gunand Tal-Bhor Dist-Pune

Date- 12/04/2022

To,

The Principal/H.O.D.

Rajgad Dnyanpeeth's,

Shri Chhatrapati Shivajiraje College Of Engineering,

Dhangawadi, Tal-Bhor, Dist -Pune.

Respected Sir,

This is certify that **Mr. TARU SACHIN ASHOK** has undergone **1 Month Internship** Under, **Mr. ABHIJEET FARGADE** from **15 Jan 2022 to 10 April 2022**. He has successfully Completed Training in our project "**CONSTRUCTION OF RESIDENTIAL BUILDING**". During training period he took keep interest in assigned work. During the training period of internship with us he was found Punctual, Hardworking, inquisitive. We wish him all success in academic endeavors and life.

Best Regards,

*A. Fargade*  
**Shrinath Developers**

Proprietor







**SHRINATH DEVELOPERS** B. E Civil, M. E STRUCTURE

Civil Engineers and Govt. Contractors

At Post-Gunand Tal-Bhor Dist-Pune

Date- 12/04/2022

To,

The Principal/H.O.D.

Rajgad Dnyanpeeth's,

Shri Chhatrapati Shivajiraje College Of Engineering,

Dhangawadi, Tal-Bhor, Dist -Pune.

Respected Sir,

This is certify that **Mr. UMBARKAR VISHESH SANTOSH** has undergone 1 Month Internship Under, **Mr. ABHIJEET FARGADE** from 15 Jan 2022 to 10 April 2022. He has successfully Completed Training in our project "**CONSTRUCTION OF RESIDENTIAL BUILDING**". During training period he took keep interest in assigned work. During the training period of internship with us he was found Punctual, Hardworking, inquisitive. We wish him all success in academic endeavors and life.

Best Regards,

*Abhijeet*  
**Shrinath Developers**

Proprietor





## CERTIFICATE



**MASS iNFRA**

Builders & Developers

Hira Arcade Building, Second floor Gala no. G-4,5,6 Vanvaswadi Satara 415003

massinfradevelopers@gmail.com

+919545330333

Date: 12/04/2022

### INTERNSHIP COMPLETION CERTIFICATE

TO WHOM IT MAY CONCERN

THIS IS TO CERTIFY THAT MISS MONIKA UDAY SHILIMKAR PURSUING DEGREE (CIVIL ENGINEERING) FROM RAJGAD DNYANDEEP TECHNICAL CAMPUS, PUNE 411041, HAS SUCCESSFULLY COMPLETED THE INTERNSHIP PROGRAM FOR 1 MONTH (FROM 15 TH JAN 2022 TO 10 TH APRIL 2022) ONLY SATURDAY AND SUNDAY WORKING AT MASS INFRA BUILDERS AND DEVELOPERS, SATARA.

DURING THE PERIOD OF THIS INTERNSHIP WE FOUND HER VERY SINCERE, CURIOUS, ANALYTICAL, HARD WORKING AND RESULT ORIENTED.

THIS ASSOCIATION WITH US WAS VERY FRUITFUL AND WE WISH HER ALL THE BEST IN HER FUTURE ENDEAVORS.

FOR MASS INFRA,

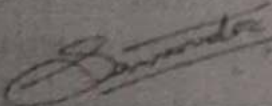
  
ER MANDAR SAWANT.



# CERTIFICATE



Hira Arcade Building, Second floor Gala no. G-4,5,6 Vanvaswadi Satara 415003  
massinfradevelopers@gmail.com +919545330333

Date: 12/ 04 /2022

## INTERNSHIP COMPLETION CERTIFICATE

TO WHOM IT MAY CONCERN

THIS IS TO CERTIFY THAT MISS SNEHAL CHANDRASHEKHARPISAL PURSUING DEGREE (CIVIL ENGINEERING) FROM RAJGAD DNYANDEEP TECHNICAL CAMPUS, PUNE 411041. HAS SUCCESSFULLY COMPLETED THE INTERNSHIP PROGRAM FOR 1 MONTH (FROM 15 TH JAN 2022 TO 10 TH APRIL 2022) ONLY SATURDAY AND SUNDAY WORKING AT MASS INFRA BUILDERS AND DEVELOPERS, SATARA.

DURING THE PERIOD OF THIS INTERNSHIP WE FOUND HER VERY SINCERE, CURIOUS, ANALYTICAL, HARD WORKING AND RESULT ORIENTED.

THIS ASSOCIATION WITH US WAS VERY FRUITFUL AND WE WISH HER ALL THE BEST IN HER FUTURE ENDEAVORS

FOR MASS INFRA,

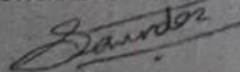
  
ER MANDAR SAWANT.



72



## *Certificate of Internship*

### To Whomsoever It May Concern

This is to certify that

**Mr . Shubham Chandrakant Nalawade.**

Of Shri. Chatrapati Shivajiraje College Of Engineering, Dhangawadi, Tal-Bhor, Dist.-Pune. Branch-Mechanical Engineering have successfully completed 30 Days (10/01/2022 To 10/02/2022) Internship at our company **Delval Flow Control PVT LTD.**

During the training, student closely worked as part of our team.

We wish them good luck for future endower & look forward to work with them in the near future.

Regards,



73



# TRISONS ENGINEERING

Office/Factory : A16, Gate No-1546, Shubhamkaroti Ind. Estate, Pirangut, Pune-412115

GST NO:-27CUJPG3G29M1Z8

MOBILE NO:-7057711301

## CERTIFICATE

### TO WHOMSOEVER IT MAY COCERN

This is to certify that **Mr. Aniket Vikas Sutar** a student of **Shri Chhatrapati Shivajiraje College of Engineering, Bhor** has successfully completed internship program from 10<sup>th</sup> January 2022 to 10<sup>th</sup> February 2022 under guidance of **Mr. Akshay Gholap**.

During the period of his internship program with us he had been exposed to different process & whatever target given he has completed, He has found punctual, hardworking and inquisitive.

We wish him every success in life and career.

Date:- 10<sup>th</sup> February 2022

Place:- Pune

  
Authorized Signatory





# TRISONS ENGINEERING

Office/Factory : A16, Gate No-1546, Shubhamkaroh Ind. Estate, Pirangut, Pune-412115

GST NO:-27CUIPG3629M1Z8

MOBILE NO:-7057711301

## CERTIFICATE

### TO WHOMSOEVER IT MAY COCERN

This is to certify that **Mr. Prasad Prakash Nalawade** a student of Shri Chhatrapati Shivajiraje College of Engineering, Bhore has successfully completed internship program from 10<sup>th</sup> January 2022 to 10<sup>th</sup> February 2022 under guidance of **Mr. Akshay Gholap**.

During the period of his internship program with us he had been exposed to different process & whatever target given he has completed, He has found punctual, hardworking and inquisitive.

We wish him every success in life and career.

Date:- 10<sup>th</sup> February 2022

Place:- Pune

  
Authorized Signatory





# TRISONS ENGINEERING

Office/Factory : A16, Gate No. 15/6, Shubhankaroti Ind. Estate, Pirangut, Pune-412115

GST NO:- 27CU1PG3629M1Z8

MOBILE NO:- 7057711301

## CERTIFICATE

### TO WHOMSOEVER IT MAY CONCERN

This is to certify that **Mr. Mayur Navnath Walhekar** a student of **Shri Chhatrapati Shivajiraje College of Engineering, Bhore** has successfully completed internship program from 10<sup>th</sup> January 2022 to 10<sup>th</sup> February 2022 under guidance of **Mr. Akshay Gholap**.

During the period of his internship program with us he had been exposed to different process & whatever target given he has completed, He has found punctual, hardworking and inquisitive.

We wish him every success in life and career.

Date:- 10<sup>th</sup> February 2022

Place:- Pune

  
Authorised Signatory



74



**SANJAY**  
CONSTRUCTION & DEVELOPERS

Add. Near Dhanwantari Hospital,  
Mahatma Phule Soc. Saswad  
sanjayconstruction899@gmail.com  
8600561755/ 9850504890

Sr.No.

Date

**INTERNSHIP COMPLETION CERTIFICATE**

MARCH. 20. 2022

PROJECT NAME : "BUILDING CONSTRUCTION PROCESS START TO FINSH".

THIS IS TO CERTIFY THAT MR. GANESH DNYANDEV BUDHE PURSUING DEGREE (CIVIL ENGINEERING) FROM RAJGAD DNYANPEETH TECHNICAL CAMPUS, PUNE-411041. HAS SUCCESSFULLY COMPLETED INTERNSHIP PROGRAM FOR 2 MONTH [FROM 08<sup>TH</sup> JAN 2022 TO 20<sup>TH</sup> MARCH 2022] AT SANJAY CONSTRUCTIONS & DEVELOPERS.

JEJURI. PUNE.

DURING THE PERIOD OF THIS INTERNSHIP WE FOUND HIM TO BE VERRY SINCERE, CURIOUS, ANALYTICAL, HARDWORKING, & RESULT ORIENTED.

HIS ASSOCIATION WITH US WAS VERY FRUITFUL AND WE WISH HIM ALL THE BEST IN HIS FUTURE ENDEAVORS.



Authorised Signature

PROP. PRASHANTH BUDHE





## INTERNSHIP COMPLETION CERTIFICATE

MARCH. 20. 2022

TO WHOME IT MAY CONCERN

Construction & Developer

PROJECT NAME : "BUILDING CONSTRUCTION PROCESS START TO FINSH".

THIS IS TO CERTIFY THAT MR. KETAN NARENDRAKUMAR JAIN PURSUING DEGREE (CIVIL ENGINEERING) FROM RAJGAD DNYANPEETH TECHNICAL CAMPUS, PUNE-411041. HAS SUCCESSFULLY COMPLETED INTERNSHIP PROGRAM FOR 2 MONTH [FROM 08<sup>TH</sup> JAN 2022 TO 20<sup>TH</sup> MARCH 2022] AT SANJAY CONSTRUCTIONS & DEVELOPERS.

JEJURI. PUNE.

DURING THE PERIOD OF THIS INTERNSHIP WE FOUND HIM TO BE VERRY SINCERE, CURIOUS, ANALYTICAL, HARDWORKING, & RESULT ORIENTED.

HIS ASSOCIATION WITH US WAS VERY FRUITHFUL AND WE WISH HIM ALL THE BEST IN HIS FUTURE ENDEAVORS.

Date

Sr.No.

8600561755/9850504890  
sanjayconstruction899@gmail.com  
Mahatma Phule Soc. Saswad  
Add. Near Dhanwantari Hospital,

CONSTRUCTION & DEVELOPERS  
**SANJAY**





## TIKONA CONSTRUCTION

SHIRWAL, TAL- KHANDALA, DIST- SATARA  
MAHARASHTRA, 412801

DATE: 11/03/2022

---

### CERTIFICATE

This is to certify that **Mr. Raut Shubham Sanjay & Mr. Wadmare Rohit Ishvar** form Rajgad Dnyanpeeths Technical Campus Dhangawadi, has successfully completed internship in Tikona Construction from 6st Jan 2022 to 15<sup>th</sup> March 2022. The study of his internship was **Industrial Training**.

We wish all the very best for his future endeavors.

Swapnil M. Sathe

(Contrator)



## TIKONA CONSTRUCTION

SHIRWAL, TAL- KHANDALA, DIST- SATARA  
MAHARASHTRA, 412801

DATE: 17/03/2022

---

### CERTIFICATE

This is to certify that **Mr. Raut Shubham Sanjay & Mr. Wadmare Rohit Ishvar** form Rajgad Dnyanpeeths Technical Campus Dhangawadi, has successfully completed internship in Tikona Construction from 6st Jan 2022 to 15<sup>th</sup> March 2022. The study of his internship was **Industrial Training**.

We wish all the very best for his future endeavors.

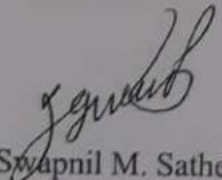
  
Swapnil M. Sathe

(Contrator)



14<sup>th</sup> Feb 2022

To whom it may concern

Innotronix Labs & Trading Pvt Ltd certifies that Ms. Poonam Devkar successfully completed the internship program from 3<sup>rd</sup> January 2022 to 18<sup>th</sup> February 2022.

During this time, Ms. Poonam Devkar displayed professional traits during his internship period and managed to complete all assigned tasks as requested. She was hardworking, dedicated, and committed. It was a pleasure having her with us in this short period.

Sincerely,

For Innotronix Labs & Trading Pvt Ltd

Authorised Signatory

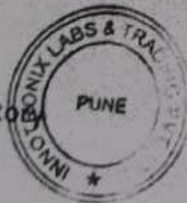

**INNOTRONIX LABS & TRADING PVT. LTD.**

DIGITAL SIGNAGES | IOT SOLUTIONS | SMART LIGHTING

Regd. Off.: Gat No. 77 & 81, Mumbai-Bangalore Highway, Village : Sasewadi, Tal. Bhor, Dist.: Pune, Pin.: 412 205, Maharashtra, INDIA.  
Contact No.: 9579662819/8329827723, Email: explore@innotronixdabs.com, Website: www.innotronixdabs.com

14<sup>th</sup> Feb 2022

## To whom it may concern

Innotronix Labs & Trading Pvt Ltd certifies that Mr. Aniket Nathu Jadhav successfully completed the internship program from 3<sup>rd</sup> January 2022 to 18<sup>th</sup> February 2022.

During this time, Mr. Aniket Nathu Jadhav displayed professional traits during his internship period and managed to complete all assigned tasks as requested. She was hardworking, dedicated, and committed. It was a pleasure having her with us in this short period.

Sincerely,

For Innotronix Labs & Trading Pvt Ltd

Authorised Signatory

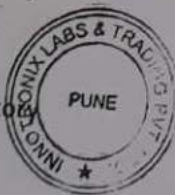

**INNOTRONIX LABS & TRADING PVT. LTD.**

DIGITAL SIGNAGES | IOT SOLUTIONS | SMART LIGHTING

Regd. Off.: Gat No. 77 & 81, Mumbai-Bangalore Highway, Village : Sasewadi, Tal.: Bhor, Dist.: Pune, Pin.: 412 205, Maharashtra, INDIA.  
Contact No.: 9579662819/8329627723, Email: explore@innotronixlabs.com, Website: www.innotronixlabs.com

14<sup>th</sup> Feb 2022

## To whom it may concern

Innotronix Labs & Trading Pvt Ltd certifies that Ms. Pooja Kondhalkar successfully completed the internship program from 3<sup>rd</sup> January 2022 to 18<sup>th</sup> February 2022.

During this time, Ms. Pooja Kondhalkar displayed professional traits during his internship period and managed to complete all assigned tasks as requested. She was hardworking, dedicated, and committed. It was a pleasure having her with us in this short period.

Sincerely,

For Innotronix Labs & Trading Pvt Ltd

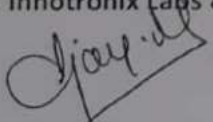

Authorised Signatory



**INNOTRONIX LABS & TRADING PVT. LTD.**

DIGITAL SIGNAGES | IOT SOLUTIONS | SMART LIGHTING

Regd. Off.: Gat No. 77 & 81, Mumbai-Bangalore Highway, Village : Sasewadi, Tal.: Bhor, Dist.: Pune, Pin.: 412 205, Maharashtra, INDIA.  
Contact No.: 9579662819/8329627723, Email: explore@innotronixlabs.com, Website: www.innotronixlabs.com

14<sup>th</sup> Feb 2022

## To whom it may concern

Innotronix Labs & Trading Pvt Ltd certifies that Mr. Ketan Vijay More successfully completed the internship program from 3<sup>rd</sup> January 2022 to 18<sup>th</sup> February 2022.

During this time, Mr. Ketan Vijay More displayed professional traits during his internship period and managed to complete all assigned tasks as requested. She was hardworking, dedicated, and committed. It was a pleasure having her with us in this short period.

Sincerely,

For Innotronix Labs & Trading Pvt Ltd

Authorised Signatory



### INNOTRONIX LABS & TRADING PVT. LTD.

DIGITAL SIGNAGES | IOT SOLUTIONS | SMART LIGHTING

Regd. Off.: Gat No. 77 & 81, Mumbai-Bangalore Highway, Village : Sasowadi, Tal.: Bhor, Dist.: Pune, Pin.: 412 205, Maharashtra, INDIA.  
Contact No.: 9579882819/8329627723, Email: explore@innotronixlabs.com, Website: www.innotronixlabs.com



14<sup>th</sup> Feb 2022

## To whom it may concern

Innotronix Labs & Trading Pvt Ltd certifies that Ms. Komal Walhekar successfully completed the internship program from 3<sup>rd</sup> January 2022 to 18<sup>th</sup> February 2022.

During this time, Ms. Komal Walhekar displayed professional traits during his internship period and managed to complete all assigned tasks as requested. She was hardworking, dedicated, and committed. It was a pleasure having her with us in this short period.

Sincerely,

For Innotronix Labs & Trading Pvt Ltd

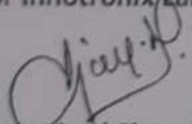
  
Authorised Signatory



**INNOTRONIX LABS & TRADING PVT. LTD.**

DIGITAL SIGNAGES | IOT SOLUTIONS | SMART LIGHTING

Regd. Off.: Gal No. 77 & B1, Mumbai-Bangalore Highway, Village : Sasewadi, Tal: Bhor, Dist.: Pune, Pin.: 412 205, Maharashtra, INDIA.  
Contact No.: 9579662819/8329627723, Email: explore@innotronixlabs.com, Website: www.innotronixlabs.com



Date 08/06/2022



To whomsoever it may concern

E-gearz Pvt. Ltd certifies that Ms. Jyoti Sanjay Jadhav successfully completed the internship program from 3<sup>rd</sup> January 2022 to 18<sup>th</sup> February 2022.

During this time, Ms. Jyoti Jadhav displayed professional traits during her internship period and managed to complete all assigned tasks as requested. She was hardworking, dedicated, and committed. It was a pleasure having her with us in this short period.

For Egearz Pvt. Ltd

Authorized Signatory

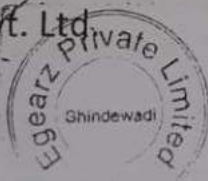

78

# SURYA Engineering Works

Naigaon road ,Dattanagar

near Star City, Residential complex

Shirwal, Maharashtra 412801

14 February 2022

To who it may concern

**SURYA Engineering Works** certifies that **Ms. Payal Ashok Kanse** successfully completed the internship from **3<sup>rd</sup> January 2022** to **18<sup>th</sup> February 2022**.

During this time **Ms Payal Ashok Kanse** displayed professional treats during his internship period and managed to complete all assigned tasks as requested.

She was hardworking , dedicated and committed . It was a pleasure having her with us in this short period.

Sincerely

For **SURYA Engineering Works**



A handwritten signature in black ink, appearing to be "Payal Kanse".

Authorised signatory



79

42

# Chheda Electricals & Electronics Pvt. Ltd.



Factory & Correspondence: Gat No.2032, Village Palshi,  
Taluka Khandala, District Satara - 412 801.  
Regd. Office : 13 Belmont Park, ICS Colony, Pune - 411007. INDIA  
CIN - U31900MH1995PTC087786



18 Feb 2022

To whom it may concern

CHHEDA ELECTRICALS & ELECTRONICS PVT. LTD certifies that Ms. Shabdashree Sutar successfully completed the internship program 3<sup>rd</sup> January 2022 to 18<sup>th</sup> February 2022.

During this time that Ms. Shabdashree Sutar displayed professional traits during his internship period and managed to complete all assigned tasks as requested. She was hardworking, dedicated and committed. It was a pleasure having her with us in this short period.

Sincerely,

For CHHEDA ELECTRICALS & ELECTRONICS PVT. LTD

  
Authorized signatory





P3

**United**  
CRANE COMPONENTS  
PRIVATE LIMITED

14th February 2022

To whom it may concern

United Crain & components Pvt.Ltd. certifies that Ms.Shital kashinath Sutar successfully completed the internship program from 3rd January 2022 to 18th February 2022.

During this time Ms.Shital kashinath Sutar displayed professional traits during his internship period and managed to complete all assigned tasks as requested. She was hardworking, dedicated, and committed. It was a pleasure having her with us in this short period.

Sincerely,

For United Crain & components Pvt.Ltd. Pune

Authorised Signatory

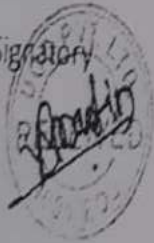

Ambika Plast



## Internship Training Certificate

TO WHOMSOEVER IT MAY CONCERN.

This is to certify that Mr. **Biradar Aniket Govind**  
Student of T.E ( Mechanical) of Shri Chhatrapati Shivajiraje college of  
Engineering has undergone Internship Programme in our company  
during the period **1-01-2022 to 31-01-2022.**

During this period he had worked and learnt technical and marketing  
aspects of the Pipe and pumps industry. We wish him all the best and  
bright future.

Date: 1-2-2022

For,

M/s Ambika Plast, Latur

Authorised Dealer



Enriching Lives  
Scanned with CamScanner

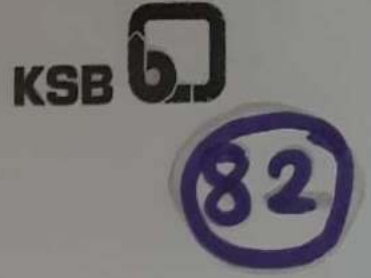

## Certificate of Training

This is to certify that,

Mr. Ravikiran Maruti Mote

Of Shri. Chhatrapati Shivajiraje College of Engineering ,Dhangwadi, Tal-Bhor, Dist-Pune, Branch-  
Mechanical Engineering have successfully completed 1 month (01.01.2022 to 31.01.2022)  
training at our company.

During the training ,he have closely worked as part of our team .

We wish him good luck for all future endover & look forward to work with them in the  
near future.

Pratik sutar.

(Executive, QM )



83



**Er. Ramesh B. Jaiswal**

Contractor

Suttar Galli, Aundha (Na.) Dist. Hingoli.

Mobile - 9422557261

Date. 10 / 04 / 2022

**To Whomsoever It May Concern**

This is to certify that Mr **Agjal Eknath Paraji** a student of BE ( Civil Engineering. From **Rajgad Dnyanpeeth Technical Campus, dhangawadi** successfully completed the Internship program at my Super Vision from 20 Dec. 2021 to 05 Feb. 2022 He has Studied on Repairing of CC Road and Drainage Pipes.

During the period of internship program with us he was found punctual and hard working.

We wish him all the best for his future life.

*R.B. Jaiswal*

Mr. R.B. Jaiswal

**Er. R. B. Jaiswal**  
ENGINEER & CONTRACTOR  
Aundha (Nag.) To. Aundha (M.S.)



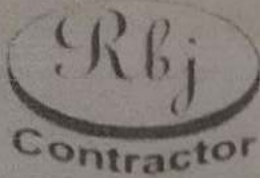

**Er. Ramesh B. Jaiswal**

**Contractor**

Suttar Galli, Aundha (Na.) Dist. Hingoli.

Mobile :- 9422557261

Date: 10/10/2022

**To Whomsoever It May Concern**

This is to certify that Mr **Chougule Omkar Balasaheb** a student of BE ( Civil Engineering, From **Rajgad Dnyanpeeth Technical Campus, Dhangawadi** has successfully completed the Internship program at my Super Vision from 20.Dec.2021 to 05 Feb. 2022 He has Studied on Repairing of CC Road and Drainage Pipes.

During the period of internship program with us he was found punctual and hard working.

We wish him all the best for his future life.

*R.B. Jaiswal*

Mr. R.B. Jaiswal

**Er. R. B. Jaiswal,**  
**ENGINEER & CONTRACTOR**  
Aundha (Nag.) To Aundha (M.)





84

# Saraswati Construction

Office Address: 915,dharmapuri,Wai, Tal-wai,dist -Satara.  
Mobile No: 9922432131 E-mail:chandrakant.bhilare@yahoo.com

Date: 15/12/2022

## TO WHOM IT MAY CONCERN

This is to certify that Mr.Dhaygude Jayesh Dhaygude ,SON of- Mr.Dhaygude Sambhaji was taking Training in our organization from 01<sup>st</sup> DEC 2022 to 05<sup>th</sup> Feb 2023. During that time we Trained him on civil work and field work on site. We found her honest, dedicated, hardworking and well-behaved during her Training period with us.

We wish his every success in life.

Saraswati Construction  
Praneshor

Saraswati Construction  
Chandrakant .S.Bhilare Contractor,BUILDER & Developer



# Saraswati Construction

Office Address: 915,dharmapuri,Wai, Tal-wai,dist-Satara.  
Mobile No: 9922432131 E-mail:chandrakant.bhilare@yahoo.com

Date: 25/12/2021

## TO WHOM IT MAY CONCERN

This is to certify that Mr.CHAVAN ROSHAN NAMDEV,SON of- Mr.CHAVAN NAMDEV JAGANNATH was taking Training in our organization from ~~01 DEC 2021~~ to ~~25 Dec~~ <sup>Feb</sup> 2022. During that time we Trained him on civil work and field work on site. We found her honest, dedicated, hardworking and well-behaved during her Training period with us.

We wish his every success in life.

Saraswati Construction

  
Proprietor

Saraswati Construction

Chandrakant .S.Bhilare Contractor,BUILDER & Developer

3



Date: 19-February-2022

## TO WHOM IT MAY CONCERN

This is to certify that **kinhale kajal Mohan** has done his internship as an implant Trainee with KP Technologies for *Web Development* from 20 December 2021 to 18 February 2022.

During this period, he demonstrated good coding skills with self-motivated attitude to learn the new things. His performance was found to be satisfactory in carrying out all the job duties.

We wish him all the best for his future endeavours.

For, KP Technologies

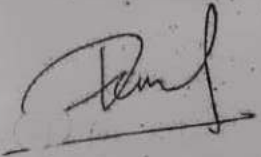

UNAL YADAV PANDHARKAR

(DIRECTOR)



KP Technologies LLP.

Contact No: 7774843561 | e : [kptechnologiz@gmail.com](mailto:kptechnologiz@gmail.com) | w : <https://kp-technologies.com>



Date: 19-February-2022

## TO WHOM IT MAY CONCERN

This is to certify that **Bhosale Shweta Sharad** has done his internship as an implant Trainee with KP Technologies for *Web-Development* from 20 December 2021 to 18 February 2022.

During this period, he demonstrated good coding skills with self-motivated attitude to learn the new things. His performance was found to be satisfactory in carrying out all the job duties.

We wish him all the best for his future endeavours.

For, KP Technologies

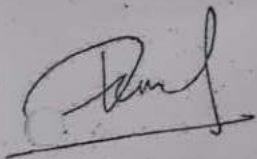

KUNAL YADAV PANDHARKAR

(DIRECTOR)



KP Technologies LLP.

Contact No: 7774843561 | e : [kptechnologiz@gmail.com](mailto:kptechnologiz@gmail.com) | w : <https://kp-technologies.com>





**INDUSTRIAL VISIT REPORT**

Date: 17 / 12 / 2021

- 1) Class : S.E & T. E Mechanical Engineering
- 2) Subject : Engineering Thermodynamics
- 3) Name of Industry : Rajgad Sugar Factory, Nigade
- 4) Date & Time : 17<sup>th</sup> December 2021 (11AM to 2PM)
- 5) Present Students : 91
- 6) Name of Faculty : Prof. S. K. Pawar

As a part of Savitribai Phule Pune University academic curriculum it required Industrial visit to any process industry which uses boiler and submission of detailed report, so we have arranged a visit to Rajgad Sugar Factory, Nigade, Tal- Bhor, Dist- Pune.

**Content of Studies:**

- 1) Rajgad Sugar Factory is placed in Nigade, Tal- Bhor, Dist- Pune uses Water Tube Boiler having capacity of 40 tonns/hr steam generation rate. Steam is produced at a pressure of 21 bar at temperature of 340<sup>0</sup>C. The fuel used is bagass of sugar cane.
- 2) The boiler uses different mountings such as Safety Valve, Water Level Indicator, Pressure Gauges, Man hole, Blow off cock, Feed check valve are mounted on boiler for proper & safe functioning.
- 3) Some boiler accessories such as Economiser, Air Preheater & Superheater are used for increasing efficiency of the system & economic enhancement of the boiler.
- 4) The turbine used for generating electricity and sugar processing is having capacity 2.5 MW.
- 5) It is IBR regulated boiler using induced draught.



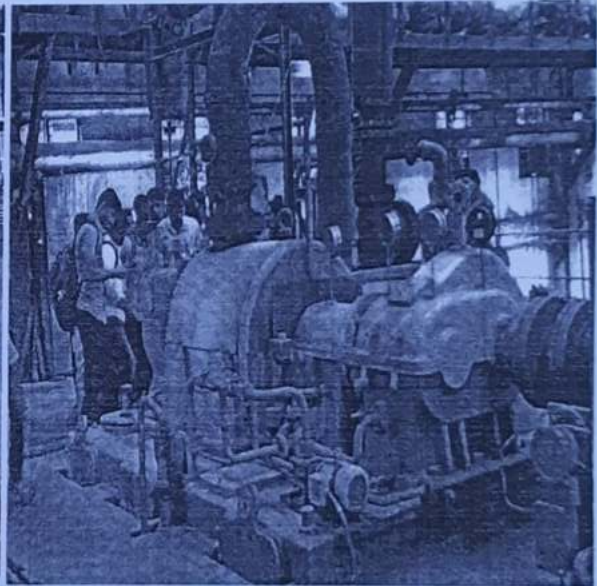
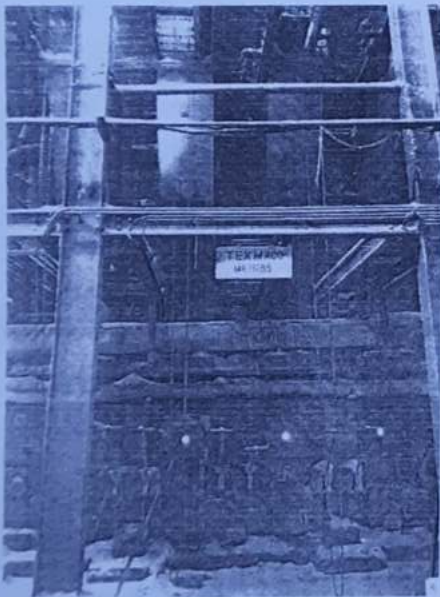
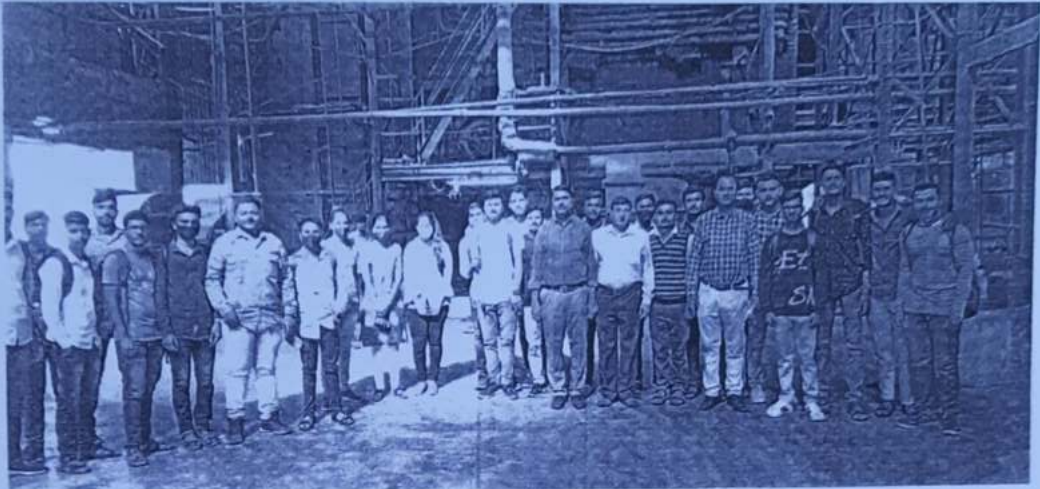

*Isar*  
Subject In-charge



*Patel*  
HOD

**Head of Department**  
Dept. of Mechanical Engineering  
Shri Chh. Shivajiraje College of Engg.  
Dhangawadi, Pune-412206





## Durvesh Engineering Works

GAT.NO:807, KHEED-SHIVAPUR,  
NEAR TOLL PLAZA, PUNE:412205.  
ALAM TAMBOLI  
7378631830  
Email :- dew2672@gmail.com



Date :- 30<sup>th</sup> JAN 2022

## Certificate

This is certify that **Mr. Sairaj Ramdas Karve** was working with our organization in the position as "Trainee" since 15<sup>th</sup> DEC 2021 to 20<sup>th</sup> JAN 2022. During his Operating the **Lathe , Drilling & Milling Machine**. We found him to be quite hard working. He done his responsibility very well. He impressed us by his skills , commitment & continuity in his hard work , He was successfully completed his period.

We wish him to success in his future life & achieved all his ambitions.

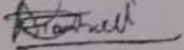
For,   
DURVESH ENGG WORKS.





## Durvesh Engineering Works

GAT NO.807, KHED-SHIVAPUR,

NEAR TOLL PLAZA, PUNE:- 412205

ALAM TAMBOLI

7378631830

Email:- dew2672@gmail.com

Date:- 30<sup>th</sup> JAN 2022

## Certificate

This is certify that Mr. Dnyanraj Pravin Chavan was working with our organization in the position as "Trainee" since 15<sup>th</sup> DEC 2021 to 20<sup>th</sup> JAN 2022. During his operating the **Lathe, Drilling & Milling Machine**. We found him to be quite hard working. He done his responsibility very well. He impressed us by his skills, commitment & continuity in his hard work, he was successfully completed his period.

We wish him to success in his future life & achieved all his ambitions.

For,

**DURVESH ENGG WORKS.**







# Shree Samarth Automation

Industrial Automation With Multi Brand Product House

## "TRAINING CERTIFICATE"

### TO WHOM SO EVER IT MAY CONCERN

This is to certify that Mr. Kishor Hiralal Jadhav, student from Shri Chhatrapati ShivajiRaje College Of Engineering, Dhangawadi has successfully completed industrial training in automation (Electrical Overhead Traveling crane control panel) from 15th Dec 2021 to 15th Jan 2022 in Shree Samarth Automation, Gokul Shirgaon, Kolhapur.

To the best of my Knowledge, he was found to be hardworking, honest and sincere.

We wish him success in his future carrier.

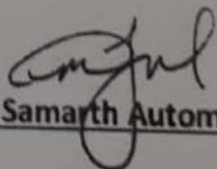

  
Shree Samarth Automation



89



**SURYA**

**ENGINEERING WORKS.**

At/post Shirwal, Tal-khandala, Dist-Satara.

21<sup>st</sup> January 2022

This is to certify that Miss. Bhosale Akanksha Vijay from Rajgad Dnyanpeeths Technical campus Dhangwadi, she has successfully completed the Internship program in our company from 13<sup>th</sup> december to 21<sup>st</sup> January 2022.

During this period we find her sincere and a hard working

We give her best wishes for her future.

For Surya Industries,

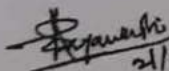
  
21/01/2022  
Mr. A.V. Suryawanshi.





# TEJAS MOTORS

TATA MOTORS

Authorised Service Station Commercial Vehicle

Certificate

This is Certify that Mr. TEJAS. S. NIGADE was working with our organization in the position as " Trainee " since 10<sup>th</sup> DEC 2021 to 20<sup>th</sup> JAN 2022. During his Training . We found him to be quite hard working. He done his responsibility very well. He impressed us by his skills , commitment & continuity in his hard work , He was successfully completed his period.

We wish him to success in his future life & achieved all his ambitions.

For,

TATA MOTORS  
TEJAS MOTORS or Tejas Motors

*Tejas S. Nigade*  
Proprietor





**DEPARTMENT OF CIVIL ENGINEERING**

Date-05/12/21

**NOTICE**

We are organizing an Industrial Visit for Third year students of Civil department at Metrological Station Kenjal , Pune. At date 07/12/2021 (Monday). Timing-11am to 1:30 pm

There will be no classes for those students who will attend the visit on that day. Students are required to be in formal and carry their Identity card.

Following faculty members will accompany the students on Industrial visit:

1. Prof. K.R. Juare
2. Prof. G.S. Yadav

*Suz*

Coordinator

Prof. K.R.Juare



*Prof. G.S. Yadav*

HOD  
H.O.D

DEPT. OF CIVIL ENGG.  
RDTC, Shri Chhatrapati Shivajiraje  
College of Engineering, Dhangwadi,  
Pune - 412206.



Rajgad Dnyanpeeth's  
Shri Chhatrapati Shivajiraje College of Engineering

Dhangwadi, Tal: Bhor, Dist: Pune, 412206.

RDTC/SCSCOE/VISIT/2021-22/ 242

Date: 07-12-21

To  
Head of department  
Automatic weather station  
Kenjal, Bhor

Subject: Regarding permission for site visit at Metrological Station (Kenjal).

Respected Sir/Madam,

As you may be aware, "Rajgad Dnyanpeeth's Shri Chhatrapati Shivajiraje College of Engineering" is one of the most reputed Engineering Institutions in Maharashtra and known for its excellent record in academics and co-curricular activities.

The College offers Bachelor degree course in Civil Engineering, Computer Engineering, Electronics and Telecommunication and Mechanical Engineering. The state-of-the-art facilities and competent faculty provide an excellent climate for the all-round development of the students.

As a part of the curriculum, the students are required to undertake Industrial Visits to a few industries of repute. We feel it will be fruitful that the students with academic background have a glimpse of the industry in order to have a better appreciation of practical applications of theory.

In the above background, we would like to visit **40 students** of Civil Engineering branch of **third year** at your esteemed department preferably, I request you, to kindly accord the necessary permission for the above visit and arrange the prerequisites for guiding the students. We assure you that our students will observe the rules and regulations that are prescribed by your department for the visitors and will in no way disturb the functioning of the department during their visit.

We shall be grateful for a favourable response.



ग्रामविकास अधिकारी  
श्री मच्छिंद्र विश्वनाथ लेंडवे  
ग्रामपंचायत केंजळ, ता.भोर, जि.पुणे



Yours faithfully,

  
Principal  
SCSCOE

ग्रामपंचायत केंजळ,  
ता.भोर, जि.पुणे

स. ए. ए. ए.



Rajgad Dnyanpeeth's

## SHRI CHHATRAPATI SHIVAJIRAJE COLLEGE OF ENGINEERING

Gat No. 237, Pune Bangalore Highway, Dhangawadi, Tal - Bhore, Dist- Pune (Maharashtra)

Dept.: Civil Engineering

Academic Year: 2021-22

### SITE VISIT REPORT

Date: - 07/12/2021

- 1) **Class:** T.E Civil
- 2) **Subject:** Hydrology and Water Resources Engineering
- 3) **Name of Site:** Metrological and Rain gauge station Kenjal, Taluka-Bhor, Dist-Pune
- 4) **Date & Time:** Monday, 07.12.2021 & 11.00 am To 1.30 pm
- 5) **Present Students:** 25/02
- 6) **Contact Person with Designation & Phone No.:** Mr. Machindra Vishvanath Lendve,  
Gramvikas Adhikari.
- 7) **Name of Faculty:** Prof. K. R. Juare, Prof. G. S. Yadav

As a part of academic curriculum, we visited the above site. We observed & studied the following things.

#### Content of studies:

- i. Study of Rain gauge Station, components of Rain gauge
- ii. Study of different types of rain gauges.
- iii. Study of metrological station.

Hydrology is the branch of civil engineering which deals with the properties, distribution and circulation of water on the surface of earth and below the surface of earth and also in the atmosphere in the form of water vapour etc. Hydrological cycle is the 'cyclic movement of water from surface of earth to the air and from air to the surface of earth'. It is also called water cycle. Precipitation is the process of the conversion of the water vapour in the atmosphere in the liquid form. These Precipitations occur in different forms i.e. Drizzle, Rain, Hail, Snow, Frost etc. From which Rain falls, to measure this rainfall some instrument is used called rain gauge. The instrument used to measure rainfall is called "rain gauge" i.e. gauging the rainwater. In our country agriculture is a very important economic activity, to support our economy. And our agriculture mainly depends upon the south-west monsoon rainfall. If dams are dry so the canals also are dry. This is a climate



hazard, which cannot be avoided but if one can predict such draught conditions one can prepare for such calamity For which we need to collect the weather data like temperature, atmospheric pressure, wind velocity and directions, moisture conditions etc. To collect weather data the weathering station are developed. That is AWS( Automatic Weather Station)

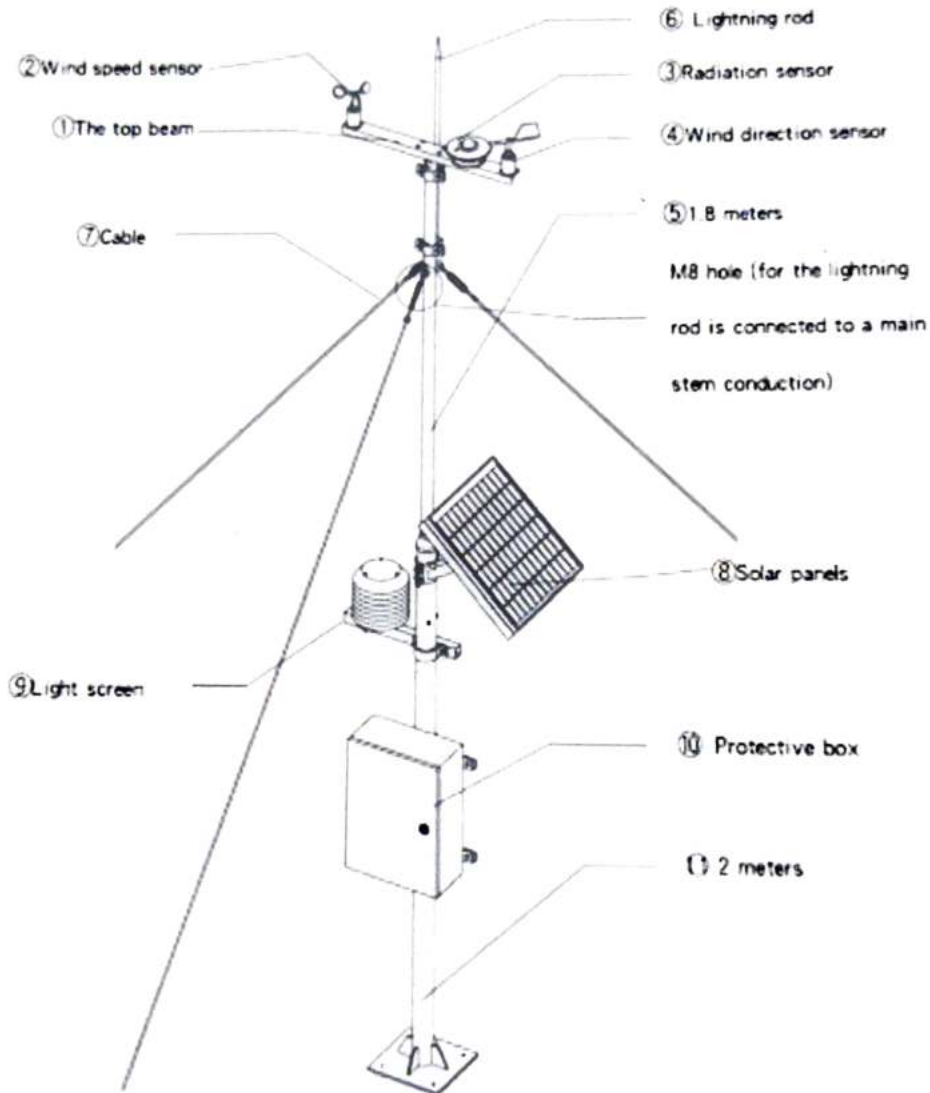

**AWS (Automatic Weather Station)**

**Fig.1: Components of AWS**



• Rain gauge It is the instrument which are used to measure rainfall is called as rain gauge Type There are two types of rain gauge are as follow

1) Non recording type rain gauge The rain gauges are very simple and are used only to collect the rain water. After a given period of time i.e. 24 hours. The water collected in the rain gauge is measured by measuring jar and the record is maintained to get monthly total and monthly average rainfall of the rain gauge station,

2) Self recording type or Automatic type rain gauge These rain gauge are record rain fall automatically i.e. record the intensity of rainfall and also the time of the occurrence, in a form of a pen trace on a clock drives chart, from which total amount of rainfall for a given period of time also can be determined. There are different type of automatic rain gauge are as follow

- a. Tipping bucket rain gauge
- b. Weighing type rain gauge.
- c. Float type rain gauge.



Fig 2: Explaining about AWS







Fig.3: Automatic weather station

*Prof. K.R. Juare*

Prof. K.R. Juare  
Faculty In-charge



*Dr. S. S. Sayyed*

Dr. S. S. Sayyed  
HOD

Head of Department  
Dept. of Civil Engineering  
Shri Chh. Shivajiraje College of Engg.  
Dhāngawadi, Pune-412206



Rajgad Dnyanpeeth's  
RAJGAD DNYANPEETH TECHNICAL CAMPUS  
Shri Chhatrapati Shivajiraje College of Engineering  
Dhangwadi, Tal. Bhor, Dist. Pune, 412206

Civil Department  
Attendance Sheet

Class- TE

| Roll No | Name of the Student  | Sign | Roll No | Name of the Student | Sign |
|---------|----------------------|------|---------|---------------------|------|
| 44      | Ushbhav Lokhande N   |      |         |                     |      |
| 66      | Aditya Shinde N      |      |         |                     |      |
| 43      | Manoj. A. Kulcard    |      |         |                     |      |
| 27      | Jaydhade Sanket      |      |         |                     |      |
| 63      | Ganesh Takar         |      |         |                     |      |
| 58      | Vishal S. Pawar      |      |         |                     |      |
| 42      | Karissagar Soreabh   |      |         |                     |      |
| 20      | Aatish Pharande      |      |         |                     |      |
| 46      | Mahangare Pratik S   |      |         |                     |      |
| 33      | Kale Rutuja P.       |      |         |                     |      |
| 51      | Mase Gauri P.        |      |         |                     |      |
| 57      | Pawar Sayali R.      |      |         |                     |      |
| 07      | Bhandalkar Pooja     |      |         |                     |      |
| 65      | Shilimkar Manika U   |      |         |                     |      |
| 62      | Pisal Snehal C.      |      |         |                     |      |
| 16      | Pratik Kadam         |      |         |                     |      |
| 18      | Kali mayuresh Sunjay |      |         |                     |      |
| 26      | Mohite Omkar S.      |      |         |                     |      |
| 21      | Mohite Shital        |      |         |                     |      |
| 29      | Yingsare Shubham     |      |         |                     |      |
| 24      | Pratibha Pisal       |      |         |                     |      |
| 08      | Shubham Raut         |      |         |                     |      |
| 50      | Shinyani Shinde      |      |         |                     |      |
| 11      | Tadhai Ajit          |      |         |                     |      |
| 12      | Gosde Rohan          |      |         |                     |      |
| 46      | Madgude Sanket       |      |         |                     |      |
| 48      | Bhargwat Yogesh      |      |         |                     |      |
| 43      | Nikhil Dhadve        |      |         |                     |      |
| 22      | Chavan Roshan        |      |         |                     |      |
| 17      | Vivek Chaudhari      |      |         |                     |      |

Faculty Incharge-Prof.K.R.Juare :





**DEPARTMENT OF CIVIL ENGINEERING**

**NOTICE**

We are organizing an Industrial Visit for Third year students of Civil department at Packaged water treatment plant at Kenjal, Pune. At date 07/12/2021. Timing-11am to 2:30 pm

There will be no classes for those students who will attend the visit on that day. Students are required to be in formal and carry their Identity card.

Following faculty members will accompany the students on Industrial visit:

1. Prof. K.R. Juare
2. Prof. G.S. Yadav

Coordinator

Prof. G.S.Yadav

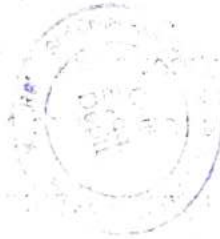
  
HOD



Rajgad Dnyanpeeth's  
Shri Chhatrapati Shivajiraje College of Engineering  
Dhangwadi, Tal: Bhore, Dist: Pune, 412206.

RDTG/SCSCOE/VISIT/2021-22/ 242

Date: 07-12-21

To  
Head of department  
Automatic weather station  
Kenjal, Bhore

Subject: Regarding permission for site visit at Metrological Station (Kenjal) & Packaged water Treatment Plant.

Respected Sir/Madam,

As you may be aware, "Rajgad Dnyanpeeth's Shri Chhatrapati Shivajiraje College of Engineering" is one of the most reputed Engineering Institutions in Maharashtra and known for its excellent record in academics and co-curricular activities.

The College offers Bachelor degree course in Civil Engineering, Computer Engineering, Electronics and Telecommunication and Mechanical Engineering. The state-of-the-art facilities and competent faculty provide an excellent climate for the all-round development of the students.

As a part of the curriculum, the students are required to undertake Industrial Visits to a few industries of repute. We feel it will be fruitful that the students with academic background have a glimpse of the industry in order to have a better appreciation of practical applications of theory.

In the above background, we would like to visit 40 students of Civil Engineering branch of third year at your esteemed department preferably, I request you, to kindly accord the necessary permission for the above visit and arrange the prerequisites for guiding the students. We assure you that our students will observe the rules and regulations that are prescribed by your department for the visitors and will in no way disturb the functioning of the department during their visit.

We shall be grateful for a favourable response.

ग्रामविकास अधिकारी  
श्री मच्छिंद्र विश्वनाथ लेंडवे  
ग्रामपंचायत केंजळ, ता. भोर, जि. पुणे

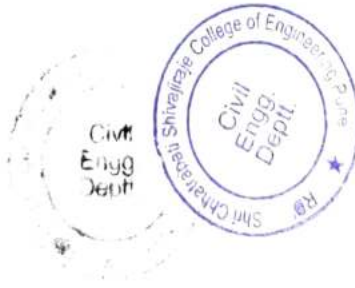

Yours faithfully,

Principal  
SCSCOE

महाराष्ट्र शासन, केंजळ,  
भोर, जि. पुणे



Dept.: Civil Engineering

Academic Year: 2021-22

SITE VISIT REPORT

Date: - 07/12/2021

- 1) **Class:** T.E Civil
- 2) **Subject:** Water Supply Engineering
- 3) **Name of Site:** Packaged Water Treatment Plant
- 4) **Date & Time:** Tuesday, 07.12.2021 & 11.00 am To 2.30 pm
- 5) **Present Students:** 42
- 6) **Contact Person with Designation & Phone No.:** Mr. Machindra Vishvanath Lendve
- 7) **Name of Faculty** Prof. G. S. Yadav, Prof.K. R. Juare

As a part of academic curriculum, we visited the above site. We observed & studied the following things.

Content of studies:

- i. Study of Packaged Water Treatment Plant by FB Tech
- ii. Study of Various Units for water treatment process
- iii. Study of techniques used for water treatment process

A branch of civil engineering concerned with the development of sources of supply, transmission, distribution, and treatment of water. Water obtained from subsurface sources, such as sands and gravels and porous or fractured rocks, is called ground water. Ground water flows toward points of discharge in river valleys and, in some areas, along the seacoast. The flow takes place in water-bearing strata known as aquifers. In an unconfined stratum the water table is the top or surface of the ground water. It may be within a few inches of the ground surface or hundreds of feet below.

**Process for treatment of water**

- Screening
- Aeration
- Sedimentation
- Filtration
- Disinfection







Site visit at kenjal Centre

The site visit for water supply engineering subject is successfully done at 07.12.2021

Prof. G.S. Yadav  
**Faculty In-charge**

  
Dr. S. S. Sayyed  
**HOD**

**Head of Department**  
Dept. of Civil Engineering  
Shri Chh. Shivaji College of Engg.  
Dhangawadi, Pune-412206



Rajgad Dnyanpeeth's  
SHRI CHHATRAPATI SHIVAJIRAJE COLLEGE OF ENGINEERING  
S. No. 237, Satara-Pune, NH-4, Dhungawadi, Tal. Bhor, Dist. Pune

DEPARTMENT OF CIVIL ENGINEERING

Academic Year: 2021-2022,

Sub: WSE

Semester - I

Site visit attendance sheet

| Class: T.E.Civil |          | Name of Site visit coordinator: Prof.G.S.Vadav |           |
|------------------|----------|--|-----------|
| S. No            | Roll No. | Student Name                                   | Signature |
| 1                | 25       | Jain Ketan Narendrakumar                       |           |
| 2                | 27       | Kadam Pratik Satish                            |           |
| 3                | 26       | Jamdhade Sanket Prakash                        |           |
| 4                | 35       | Kulkarni Manoj Kulkarni                        |           |
| 5                | 59       | Tane Karthik Chander                           |           |
| 6                | 58       | Mathangara Pratik Sudam                        |           |
| 7                | 18       | Dhadve Nikhil Dilip                            |           |
| 8                | 09       | Budhe Ganesh Dnyanadev                         |           |
| 9                | 08       | Bhilane Saurabh Maruti                         |           |
| 10               | 06       | Bhagwat Poolesh Shriram                        |           |
| 11               | 06       | Miyekar Sankesh Suresh                         |           |
| 12               | 15       | Chikane Jay Dattatraya                         |           |
| 13               | 03       | Anbhore Jushar Ashish                          |           |
| 14               | 07       | Bhandalkar Pooja Ramaling                      |           |
| 15               | 67       | Giriyasavi Tyoti Balu                          |           |
| 16               | 23       | Jadhav Shital Subhash                          |           |
| 17               | 24       | Jadhav Shubham Nannath                         |           |
| 18               | 62       | KARCHUNDE Ramesh S.                            |           |
| 19               | 63       | Taru Saehin Ashok                              |           |
| 20               | 19       | Dhagade Atesh Sambhaji                         |           |
| 21               | 14       | Chavan Aniket Kanta                            |           |
| 22               | 20       | Grade Rohan Rajendra                           |           |
| 23               | 51       | Pisal Snehal Chintreshaker                     |           |
| 24               | 46       | Pawar Sayali Ramindra                          |           |
| 25               | 28       | Kale Rutuja Dnyaneshwar                        |           |
| 26               | 54       | Shilimkar Manika Uday                          |           |
| 27               | 34       | Kshirsagar Saurabh Sunil                       |           |
| 28               | 35       | Mohite Omkar Sambhaji                          |           |
| 29               | 36       | Lothande Vaibhav Dilip                         |           |
| 30               | 49       | Pharande Atish Ashok                           |           |





| S. No | Roll No. | Student Name                | Signature          |
|-------|----------|-----------------------------|--------------------|
| 31    | 55       | Shinde Aditya Nandkumar     | <i>[Signature]</i> |
| 32    | 39       | Mane Amit Jagdish           | <i>[Signature]</i> |
| 33    | 45       | Pansare Shubham Naunath     | <i>[Signature]</i> |
| 34    | 53       | Raut Shubham Sanjay         | <i>[Signature]</i> |
| 35    | 32       | Kolekar Akshay Dattatray    | <i>[Signature]</i> |
| 36    | 68       | Kavched Dattatray Abhimanyu | <i>[Signature]</i> |
| 37    | 04       | Bandal Nikhil Bantel        | <i>[Signature]</i> |
| 38    | 29       | Pravinsudhir Karale         | <i>[Signature]</i> |
| 39    | 12       | Kiran Yuvraj Chavan         | <i>[Signature]</i> |
| 40    | 48       | Shubham Sanjay Pagnuck      | <i>[Signature]</i> |
| 41    | 10       | Murke Rajendra Chaudhari    | <i>[Signature]</i> |
| 42    | 13       | Roshan Nandev Chavan        | <i>[Signature]</i> |
| 43    |          |                             |                    |
| 44    |          |                             |                    |
| 45    |          |                             |                    |
| 46    |          |                             |                    |
| 47    |          |                             |                    |
| 48    |          |                             |                    |
| 49    |          |                             |                    |
| 50    |          |                             |                    |
| 51    |          |                             |                    |
| 52    |          |                             |                    |
| 53    |          |                             |                    |
| 54    |          |                             |                    |
| 55    |          |                             |                    |
| 56    |          |                             |                    |
| 57    |          |                             |                    |
| 58    |          |                             |                    |
| 59    |          |                             |                    |
| 60    |          |                             |                    |
| 61    |          |                             |                    |
| 62    |          |                             |                    |
| 63    |          |                             |                    |
| 64    |          |                             |                    |
| 65    |          |                             |                    |
| 66    |          |                             |                    |
| 67    |          |                             |                    |
| 68    |          |                             |                    |
| 69    |          |                             |                    |
| 70    |          |                             |                    |

*[Signature]*  
Site Visit Teacher



*[Signature]*  
Head of Department

Head of Department  
Dept. of Civil Engineering  
Shri Chh. Shivajiraje College of Engg.  
Dhangawadi, Pune-412200

93

**ACG**  
CAPSULES

15<sup>th</sup> January 2022

WHOMSOEVER IT MAY CONCERN

This is to certify that Mr. Shinde Adarsh Santosh form Rajgad Dnyanpeeths Technical Campus Dhangawadi, has successfully completed internship in our organization from 6<sup>th</sup> December 2021 to 15<sup>th</sup> January 2022. The study of his internship was Industrial Training.

During this period we found him to be science and hard working.

We wish all the very best for his future endeavors.

For ACG Capsules,

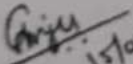
  
Anju Chaudhary  
15/01/2022  
BU - HR Head

Regd. Office:

Plot No. 131, Kandivall Industrial Estate, Kandivall (West), Mumbai - 400 067, India

Phone: +91 22 7194 8400

ACG Associated Capsules Pvt. Ltd.

Factory: Gat No. 322,323, Shirwal, Tal. Khandala, Dist. Satara, Maharashtra - 412 801, India

Phone: +91 77200 89461/2/3 | Email: Sales, acpl@acg-world.com | Website: www.acg-world.com

CIN No: U24239MH1961PTC012061 | GST No: 27AAACA4769K1ZD



# ACG

CAPSULES

15<sup>th</sup> January 2022

## WHOMSOEVER IT MAY CONCERN

This is to certify that **Mr. Nikam Omkar Sunil** form Rajgad Dnyanpeeths Technical Campus Dhangawadi, has successfully completed internship in our organization from 6<sup>th</sup> December 2021 to 15<sup>th</sup> January 2022. The study of his internship was **Industrial Training**.

During this period we found him to be science and hard working.

We wish all the very best for his future endeavors.

For ACG Capsules,

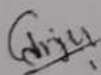
  
15/01/2022  
Anju Chaudhary

BU - HR Head

Regd. Office:

Plot No. 131, Kandivali Industrial Estate, Kandivali (West), Mumbai - 400 067, India

Phone: +91 22 7194 8400

ACG Associated Capsules Pvt. Ltd.

Factory: Gat No. 322,323, Shirwal, Tal. Khandala, Dist. Satara, Maharashtra - 412 801, India.

Phone: +91 22200 89461/2/3 | Email: Sales\_acg@acg-world.com | Website: www.acg-world.com

CIN No. U24239MH1961PTC012061 | GST No. 27AAACAA4769K17D



# ACG

CAPSULES

15<sup>th</sup> January 2022

WHOMSOEVER IT MAY CONCERN

This is to certify that **Mr. Kondhalkar Shubham Prakash** form Rajgad Dnyanpeeths Technical Campus Dhangawadi, has successfully completed internship in our organization from 6<sup>th</sup> December 2021 to 15<sup>th</sup> January 2022. The study of his internship was **Industrial Training**.

During this period we found him to be science and hard working.

We wish all the very best for his future endeavors.

For ACG Capsules,

  
Anju Chaudhary

BU - HR Head

Regd. Office:  
Plot No. 131, Kandivali Industrial Estate, Kandivali (West), Mumbai - 400 067, India  
Phone: +91 22 7194 8400

ACG Associated Capsules Pvt. Ltd.  
Factory: Gat No. 322,323, Shirwal, Tal. Khandala, Dist. Satara, Maharashtra - 412 801, India  
Phone: +91 77200 89461/2/3 | Email: Sales.acpl@acg-world.com | Website: www.acg-world.com  
CIN No: U24239MH1961PTC012061 | GST No: 27AAACA4769K1ZD



# ACG

CAPSULES

15<sup>th</sup> January 2022

WHOMSOEVER IT MAY CONCERN

This is to certify that **Mr. Harihar Kiran Dipak** form Rajgad Dnyanpeeths Technical Campus Dhangawadi, has successfully completed intcrnship in our organization from 6<sup>st</sup> December 2021 to 15<sup>th</sup> January 2022. The study of his internship was **Industrial Training**.

During this period we found him to be science and hard working.

We wish all the very best for his future endeavors.

For ACG Capsules,

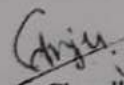
  
Anju Chaudhary  
15/01/2022

BU - HR Head

Regd. Office:

Plot No. 131, Kandivali Industrial Estate, Kandivali (West), Mumbai 400 067, India

Phone: +91 22 7194 8400

ACG Associated Capsules Pvt. Ltd.

Factory: Gat No. 322,323, Shirwal, Tal. Khandala, Dist. Satara, Maharashtra - 412 801, India

Phone: +91 77200 89461/2/3 | Email: Sales, acpl@acg-world.com | Website: www.acg-world.com

CIN No: U24239MH1961PTC012061 | GST No: 27AAACA4769K1ZD



# ACG

CAPSULES

15<sup>th</sup> January 2022

WHOMSOEVER IT MAY CONCERN

This is to certify that **Mr. Wadkar Jagdish Manik** form Rajgad Dnyanpeeths Technical Campus Dhangawadi, has successfully completed internship in our organization from 6<sup>th</sup> December 2021 to 15<sup>th</sup> January 2022. The study of his internship was **Industrial Training**.

During this period we found him to be science and hard working.

We wish all the very best for his future endeavors.

For ACG Capsules,

*Anju*  
15/01/2022  
Anju Chaudhary  
BU - HR Head

Regd. Office:

Plot No. 131, Kandivali Industrial Estate, Kandivali (West), Mumbai - 400 067, India  
Phone: +91 22 7194 8400

ACG Associated Capsules Pvt. Ltd.

Factory: Gat No. 322,323, Shirwal, Tal. Khandala, Dist. Satara, Maharashtra - 412 801, India  
Phone: +91 77200 89461/2/3 | Email: Sales, acpl@acg-world.com | Website: www.acg-world.com  
CIN No: U24239MH1961PTC012061 | GST No: 27AAACA4769K1ZD





15<sup>th</sup> January 2022

WHOMSOEVER IT MAY CONCERN

This is to certify that **Mr. Mujawar Ashraf Shabbir** form Rajgad Dnyanpeeths Technical Campus Dhangawadi, has successfully completed internship in our organization from 6<sup>th</sup> December 2021 to 15<sup>th</sup> January 2022. The study of his internship was **Industrial Training**.

During this period we found him to be science and hard working.

We wish all the very best for his future endeavors.

For ACG Capsules,

*(Anju)*  
15/01/2022

Anju Chaudhary

BU – HR Head

Regd. Office:  
Plot No. 131, Kandivali Industrial Estate, Kandivali (West), Mumbai – 400 067, India  
Phone: +91 22 7194 8400

ACG Associated Capsules Pvt. Ltd.  
Factory: Gat No. 322,323, Shirwal, Tal. Khandala, Dist. Satara, Maharashtra – 412 801, India  
Phone: +91 77200 89461/2/3 | Email: Sales, acpl@acg-world.com | Website: www.acg-world.com  
CIN No: U24239MH1961PTC012061 | GST No: 27AAACA4769K1Z1D



94



21 th January 2022

WHOMSOEVER IT MAY CONCERN

This is to certify that **Mr. Gujar Chirag Rajesh** form **Rajgad Dnyanpeeths Technical Campus Dhangawadi**, has successfully completed internship in our organization from 2nd December 2021 to 21 January 2022. The study of his internship was **Industrial Training**.

During this period we found him to be science and hard working. We wish all the very best for his future endeavors.

For CaDME Metal Crafts,

**Vivek Karale**  
HR Head

---

**CaDME Metal Crafts Pvt. Ltd.**  
Khedekar Industrial Estate, Narhe Dhayri Road, Pune.  
CIN No: U24239MH1961PTC0 GST No: 27AAACA4769KIZD

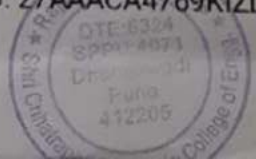





**AURA LASERFAB PVT. LTD.**

Gat No 1021, Village Shirwal  
Pune - Bangalore Highway, Tal. Khandala  
Dist. Satara, Pin - 412801  
Phone : +91 2169 244545 / 46  
E mail : sales@auralaser.in  
Website : www.auralaser.net  
CIN No : U29299PN2006PTC128520



## CERTIFICATE

### TO WHOMSOEVER THIS MAY CONCERN

This is to certify that Mr. Akash K Pisal, a student of RD'SCSOE has successfully completed a internship in the field of Engineering from 01Dec to 10 Jan 2022.

His internship activities include familiarization to all the departments, their operations and process along with a overview involved in the production process of the organization.

During the period of his internship program with us, he had been exposed to different processes and was found diligent, hardworking and inquisitive.

We wish him every success in his life and career

For, Aura Laserfab Pvt.Ltd

Authorised Signature



Place

Date



96



## BALIRAJA ENTERPRISES

6W5F+W99, Dhangawadi Rd, Dhangwadi, Maharashtra 412213.  
MOBILE NO. - 7972223446.

31<sup>st</sup> December 2021.

### WHOMESOVER IT MAY CONCERN

This is to certify that Mr. Kadam Vaibhav Vilas from Rajgad Dnyanpeeths Technical Campus Dhangawadi, has successfully completed internship in our organization from 1<sup>st</sup> December 2021. To 31<sup>st</sup> December 2021. The study of his internship was Industrial Training.

For Baliraja Enterprises,

Baliraja industries

Milind Tanpure

Proprieter

Proprieter





## **BALIRAJA ENTERPRISES**

6WSF+W99, Dhangawadi Rd, Dhangawadi, Maharashtra 412213.  
MOBILE NO. - 7972223446.

31<sup>st</sup> December 2021.

### **WHOMESOVER IT MAY CONCERN**

This is to certify that Mr. Chavan Omkar Balkrushna from Rajgad Dnyanpeeths Technical Campus Dhangawadi, has successfully completed internship in our organization from 1<sup>st</sup> December 2021. To 31<sup>st</sup> December 2021. The study of his internship was Industrial Training.

For Baliraja Enterprises,

Baliraja Industries

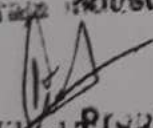
  
Mihnd Tanpure.  
Proprietor.



BOMBAY GENERATOR (Engineering Workshop) LTD**Internship certificate**

This is to certify that Mr. Sapkal Tushar Dattatray, student from Rajgad Dyanpeeth's Shri Chhatrapati Shivajiraje College of Engineering Dhangawadi Tal. Bhor, Pune. has successfully completed industrial training in BOMBAY GENERATOR WAI. (Engineering Workshop) from 1 Dec 2021 to 30 Dec 2021. During Accademic Year 2021-2022.

To the best of my Knowledge, he was found to be hardworking, honest and sincere. We wish him success in his future carrier.

Date:- 3 MAY 2022

**BOMBAY GENERATOR**

*Sapkal*  
Proprietor

Authorised Signatory

(BOMBAY GENERATOR WAI)



# D.B.LAD ENGINEERING WORKS

GAT NO 326, CHOPALA, PUNE BANGLORE HIGHWAY, SHIRWAL TAL-KHANDALA DIST-SATARA  
Email- [dblad.engworks@rediffmail.com](mailto:dblad.engworks@rediffmail.com)  
Mob No-9822653969



Date -05 /01/2022

## TO WHOMSOEVER IT MAY CONCERN

This is to certify that **Mr. Kazi Azam Raj** has successfully completed his internship training from our company. He was an intern for a period of 1 Month (**1st December 2021 – 31st December 2021**). He was found sincere and hardworking during the tenure.

We wish him every success in life.

D.B.LAD ENGINEERING WORKS,  
D B LAD ENGINEERING WORKS

  
Proprietor

Authorized Signature





GE India Industrial Pvt Ltd  
Chakan MIDC Phase II, A-  
78/1, Vasuli Village, Khed  
Taluka, Pune  
Maharashtra 410501

Date: 31/01/2022

**Certificate of Training**

**To Whomsoever it may concern**

This is to certify that,

**Mr. Assad Gaffar Shaikh**

Of Shri Chhatrapati Shivajiraje College of Engineering, Dhangawadi, Tal. Bhor, Dist. Pune, Branch Mechanical Engineering have successfully completed 30 Days training from 1/12/2021 to 30-12-2021.

During the training, student have closely worked as a part of our team.

*We wish them good luck for all future endeavor and look forward to work with them in the near future.*

Regards

P P N Rajendran  
People Operations  
GE South Asia



## CERTIFICATE

This is to certify that **Mr. Mahangare Aniket Bharat** Student of Rajgad Dnyanpeeth's Technical campus, Dhangwadi. Permanent Registration Number -71918334M, has successfully completed his **Internship** in our organization from **1 DEC 2021 TO 10 JAN 2022**. During academic year 2021-2022, as partial fulfillment of the degree (Mechanical Engineering) course.



(For: KLAUS MULTIPARKING SYSTEM SHIRWAL.)



  
Manager  
(KLAUS multiparking, Shirwal)

**CERTIFICATE**

This is to certify that **MR. Parte Pratik Atmaram** Student of Rajgad Dnyanpeeth's Technical campus, Dhangwadi. Permanent Registration Number - **71918353H**, has successfully completed his **Internship** in our organization from **1 DEC 2021 TO 10 JAN 2022**. During academic year 2021-2022, as partial fulfillment of the degree (Mechanical Engineering) course.



(For: KLAUS MULTIPARKING SYSTEM SHIRWAL.)

  
Manager  
(KLAUS multiparking, Shirwal)





101

# OMKAR ENTERPRISES

Sr.no. 38/02, Shed No. 04 Near Nanded City Main Gate, Sinhgad Road, Dhayal Pune-411041

Sunil Shtap - 9960908670, 7972039254 E-mail : omkarentprises@gmail.com

## CERTIFICATE

This is to certify that Mr. NIKALAJE SURAJ RAJENDRA Student of Rajgad Dnyanpeet's Technical Campus, Dhangawadi. Permanent Registration Number- 72171059L has successfully completed his internship in our Company From 01 Dec 2021 to 31 Dec 2021. During academic year 2021-2022, as partial fulfillment of the Degree in Mechanical Engineering Course.

Omkar Enterprises

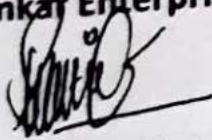

Proprietor Sign

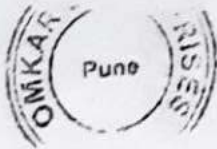

# OMKAR ENTERPRISES

Sr.no. 38/02, Shed No. 04 Near Nanded City Main Gate, Sinhgad Road, Dhyari Pune-411041

Sunil Shtap - 9960908670, 7972039254 E-mail : omkarentprises@gmail.com

## CERTIFICATE

This is to certify that Mr. PANDIT SANKET VINOD Student of Rajgad Dnyanpeet's Technical Campus, Dhangawadi. Permanent Registration Number- 72171105H has successfully completed his internship in our Company From 01 Dec 2021 to 31 Dec 2021. During academic year 2021-2022, as partial fulfillment of the Degree in Mechanical Engineering Course.

Omkar Enterprises

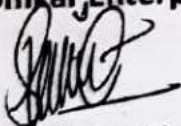

Proprietor Sign





SANHUA INDIA PRIVATE LIMITED

三花印度私人有限公司

102

GAT NO 227, BEHIND KORES FORGING, MAHALUNGE, CHAKAN, PUNE- 410501

## Internship Training Certificate

TO WHOMSOEVER IT MAY CONCERN

This is to certify that Mr. Sagar Ramdas Chavan

Student of T.E (Mechanical) of Shri Chhatrapati Shivajiraje college of engineering has done his internship in Production Department in our company. from 1<sup>st</sup> Dec 2021 to 31<sup>th</sup> Dec 2021.

He has been helping to set up the production line. How to manage human resources, inventory levels, and audit documentation, with a special emphasis on product quality. He learned about thermal expansion valves, chillers, and water pumps during this one month period.,

During his internship, he has demonstrated his skills with self-motivation to learn new skills about thermal system. His performance exceeded our expectations and he was able to complete the target on time.

We wish him all the best for his upcoming future.

Date- 10<sup>th</sup> Jan 2022

For,



SANHUA INDIA PVT LTD .





IATF 16949:2016

Plant I : BSI Certificate No. : 524956-000

IATF No : 0344665

Plant II : BSI Certificate No. : 524956-001

IATF No : 0344981

103



**Speciality  
Sintered**

Products Pvt. Ltd.

## Internship Training Certificate

TO WHOMEVER IT MAY CONCERN

This is to certify that Mr. Suraj Vasant Jagtap  
Student of T.E (Mechanical) of Shri Chhatrapati Shivajiraje  
college of Engineering has undergone Internship Programme in  
our company during the period 1 Dec 2021 to 30 Dec 2021.

During this period he had worked and learnt automation  
projects technical work and his maintenance work. We wish  
him all the best and bright future.

Date: 25 May 2022

For,

Speciality Sintered Product

Pvt. Ltd, Shirwal,



REGD. OFFICE & PLANT I: Gat 409/1, Nanekarwadi, Chakan - Talegaon Road, Chakan, Pune - 410 501 (India) Tel. No. : 02135 - 278800

PLANT II: Plot No. 1C, Gat No. 1122, 1129, 1140, 1295, 1296, Global Tech Park, Godrej Lawkim Road,  
30 Post - Shirwal, Tal. Khandala, Dist. Satara. 412 801 India Tel. No. : 02169 - 244544

E-MAIL: [info@sslpune.com](mailto:info@sslpune.com), [sales@sslpune.com](mailto:sales@sslpune.com)

WEBSITE : [www.specialitysintered.com](http://www.specialitysintered.com)

CIN NO. : U34300PN1998PTCO12837



31<sup>ST</sup> December 2021

WHOMSOEVER IT MAY CONCERN

This is to certify that Mr. Galkwad Sourabh Anaso form Rajgad Dnyanpeeths Technical Campus Dhangarwadi, has successfully completed internship in our organization from 1st December 2021 to 31<sup>ST</sup> December 2021 The study of his internship was Industrial Training.

During this period we found him to be science and hard working.

We wish all the very best for his future endeavors.

For ACG Worldwide

Anja Chaudhary  
8/1/2/21

BU - HR Head

Regd. Office:

Plot No. 131, Kandivali Industrial Estate, Kandivali (West), Mumbai - 400 067, India

Phone: +91 22 7194 8400

ACG Associated Capsules Pvt. Ltd.

Factory: Gat No. 322,323, Bhirwal, Tul. Khandala, Dist. Satara, Maharashtra - 412 801, India

Phone: +91 77200 89461/2/3 | Email: Sales\_acg@acg-world.com | Website: www.acg-world.com

CIN No: U24239MH11961PTC012061 | GST No: 27AAACA4769K1ZD



# ACG

## WHOMSOEVER IT MAY CONCERN

This is to certify that Mr. Algude Swapnil Dilip form Rajgad Dnyanpeeths Technical Campus Dhangawadi, has successfully completed internship in our organization from 1st December 2021 to 31st December 2021 The study of his internship was Industrial Training.

During this period we found him to be science and hard working.

We wish all the very best for his future

For ACG Worldwide

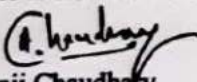
  
Anji Chaudhary

BU - HR Head



**Regd. Office :**

Pam House, Plot No.127, Kandivali Industrial Estate, Charkop, Kandivali (West), Mumbai - 400067, India  
Phone : +91 22 5012 0700/01/02

**ACG Pam Pharma Technologies Private Limited**

Palashi Road, Gat No 821/B, Block - D, Shirwal, Taiuka - Khandala, Dist - Satara, Pin Code No. : 412 801, India  
Phone : +91 7767007040/41/42/43 | Email : info.pamshirwala@acg-world.com | Website : www.acg-world.com  
CIN No. : U24239MH1972PTCO15632 | GST No. : 27AAACP4776H126



SHRI PANDURANG PRATISHTHAN PANDHARPUR,  
**KARMAYOGI INSTITUTE OF TECHNOLOGY**

GAT No. 124, 125, AT POST SHELVE, PANDHARPUR, MAHARASHTRA INDIA - 413304  
 (APPROVED BY AICTE, NEW DELHI, RECOGNIZED BY GOVT. OF MAHARASHTRA  
 AND AFFILIATED DR. BABASAHEB AMBEDKAR TECHNOLOGICAL UNIVERSITY, LONERE.)  
 www.karmayogiinstitute.ac.in



✉ principalkec6326@gmail.com  
 ☎ +91 8554006300

INSTITUTE CODE 6326

Ref. No. KEC/Admin/2021-22/ 1105

Date: - 18/11/2021

To,  
 Prof. S. P. Salunkhe,  
 Assistant Professor,  
 Dept. of Civil Engineering,  
 RD's, SCSCOE, Dhangwadi, Pune

**Subject:** - Letter of gratitude....

Dear Sir,

This is an appreciation for your valuable time and interest in conduction of online Expert Lecture on, "Design of L & T-Shape Retaining wall" on 18/11/2021 in our Institute. Around 65 students from Civil Engineering stream were present for valuable session. As per student feedback the session was beneficial to enhance their knowledge and skills in this particular area

We are thankful for sharing your valuable time for our students and hope you will extend the same cooperation in future also

Thanking you



*S.P.*  
 Principal



# VASANTDADA PATIL PRATISHTHAN'S COLLEGE OF ENGINEERING AND VISUAL ARTS

# 106

(Formerly Known as Padmabhushan Vasantdada Patil Pratishthan's College of Engineering)

TRUST REGD. NO. F. 6736 (MUMBAI)

NAAC ACCREDITATION FOR 5 YEARS : (28.03.2019 to 27.03.2024)

NBA ACCREDITED COURSES : (During 15.03.2012 to 14.03.2015) COMP. ENGG./ ELEX. ENGG. / EXTC. ENGG./ I.T.

(F.No 28-110 / 2010 - NBA Dated 02/04/2012)

Office : Vasantdada Patil Educational Complex, Eastern Express Highway, Padmabhushan Vasantdada Patil Marg, Sion, Mumbai - 400 022.

Tel: +91 22 2084 0325, 7226, 7228, 7229 | Fax: +91 22 2403 8717 | E-mail : principal@pvppcoe.ac.in | Web: www.pvppcoe.ac.in

Founder :  
Late MANOHAR PHALKE  
M.L.C.

Treasurer :  
Adv. PRALHAD G. DESAI

President :  
Shri. NANDKUMAR M. KATKAR

Campus Director :  
Prof. ASHOK CHAVAN

General Secretary :  
Adv. APPASAHEB S. DESAI

Principal :  
Dr. ALAM N. SHAIKH

PVPPCOE/Office/2021-22

Date: 17/11/2021

To

Prof. S. B. Shirke,  
Assistant Professor  
RD's, S.C.S.C.O.E, Dhangwadi, Pune

Subject-Letter of gratitude..

Dear Madam,

This is an appreciation for conduction of Online **Expert lecture on, "Data base and Management"** dated on 17/11/2021 in our Institute for the student of Computer Engineering.

As per student feedback the session was interesting and beneficial to enhance their knowledge and skills in fait particular subject.

We are thankful for shearing your valuable time and hope you will extend the same cooperation in future also.

Thanking You



Principal

Vasantdada Patil Pratishthan's College of  
Engineering and Visual Arts  
Vasantdada Patil Educational Complex, Eastern  
Express Highway, Padmabhushan Vasantdada  
Patil Marg, Sion, Mumbai - 400 022.





SHRI PANDURANG PRATISHTHAN PANDHARPUR,  
**KARMAYOGI INSTITUTE OF TECHNOLOGY**

GAT NO. 124, 125, AT POST SHELVE, PANDHARPUR, MAHARASHTRA INDIA - 413304  
 (APPROVED BY AICTE, NEW DELHI, RECOGNIZED BY GOVT. OF MAHARASHTRA  
 AND AFFILIATED DR. BABASAHEB AMBEDKAR TECHNOLOGICAL UNIVERSITY, LONERE.)  
[www.karmayoginstitute.ac.in](http://www.karmayoginstitute.ac.in)



✉ [principalkec6326@gmail.com](mailto:principalkec6326@gmail.com)  
 ☎ +91 8554006300

**INSTITUTE CODE 6326**

Ref. No. KEC/Admin/2021-22/ 1106

Date: - 18/11/2021

**To,**  
 Prof. T. M. Dudhane,  
 Associate Professor,  
 Dept. of E&TC  
 RD's, SCSCOE, Dhangwadi, Pune

**Subject:** -Letter of gratitude....

Dear Sir,

This is an appreciation for your valuable time and interest in conduction of online Expert Lectureon, "**Machine learning & Its Application**" on 17/11/2021 in our Institute. Around 58 students from Electronics & Telecommunication Engineering stream were present for valuable session. As per student feedback the session was beneficial to enhance their knowledge and skills in this particular area

We are thankful for sharing your valuable time for our students and hope you will extend the same cooperation in future also

Thanking you

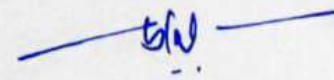

  
 Principal

108



Samarth Rural Educational Institute Rajuri's

# Samarth Group Of Institutions

Faculty Of Management/Engineering

Approved by AICTE New Delhi, Govt. of Maharashtra & Affiliated to University of Pune.



A/p.: Belhe(Bangarwadi), Tal : Junnar, Dist : Pune, Pin : 412 410, Ph.No.:02132-276753/54, Fax:276751,

Mob.: 9766588077, 9404202534, Email: sibmbelhe@rediffmail.com, Web.:www.sreir.org

Ref. No.

Date:-15/11/2021

To,  
Prof. P. G. Gaikwad  
RD's SCSCOE, Dhangwadi  
Pune.

Respected Madam,

On behalf of the Civil Department of Samarth Group of Institutions, Faculty of Engineering, we wanted to express our deep gratitude to you for conduction of Expert Lecture on the topic "Water Treatment Plant" on 15<sup>th</sup> Nov 2021. It was really informative and useful. Definitely all the participants have benefited from your talk.

We are very much thankful to you for making it convenient to be with us.

Once again, thank you for making the Expert Lecture successful, and we expecting your continues support in future also.

Again, many thanks for your valuable time.

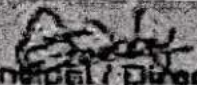
  
Principal / Director  
Samarth Group of Institutions  
College Of Engineering, Belhe



110

# M/s AFW SHIRWAL

(M/S AMBIKA FABRICATION WORKS ISO 9001-2015 COMPANY)

Milkat No – 2993, At/Post – Shirwal, Tal – Khandala, Dist – Satara, Near Shirke Paper Mill.

Pin code No – 412801, Email – [afwshirwal@gmail.com](mailto:afwshirwal@gmail.com), mob: 7507555066

Ref. No: HR/2021/11

Date: JANUARY 31, 2022

Mr. Ankit Ramakant Pawar  
Khandala

## TO WHOM IT MAY CONCERN INTERNSHIP COMPLETION LETTER

This is to certify that MR. PAWAR ANKIT RAMAKANT student of Rajgad Dnyanpeeth's Technical Campus, Dhangawadi. Permanent Registration Number (PRN NO):-71918347C & ROLL NO :- TME18F066 has successfully completed his 4 weeks Internship in our organization from 1 NOV 2021 To 31 JAN 2022. During academic year 2021-2022, as partial fulfilment of the Degree (Mechanical Engineering) course.

During this period he had worked and CNC & VMC machine working in the mechanical industry. We wish him all the best and bright future.

For M/s AFW SHIRWAL

(M/s Ambika Fabrication works)

D.P. Nigade  
President (CFO/HR)





# VASANTDADA PATIL PRATISHTHAN'S COLLEGE OF ENGINEERING AND VISUAL ARTS

109

(Formerly Known as Padmabhushan Vasantdada Patil Pratishthan's College of Engineering)

TRUST REGD. NO. F. 6736 (MUMBAI)

NAAC ACCREDITATION FOR 5 YEARS : (28.03.2019 to 27.03.2024)

NBA ACCREDITED COURSES : (During 15.03.2012 to 14.03.2015) COMP. ENGG./ ELEX. ENGG. / EXTC. ENGG./ I.T.

(F.No 28-110 / 2010 - NBA Dated 02/04/2012)

Office : Vasantdada Patil Educational Complex, Eastern Express Highway, Padmabhushan Vasantdada Patil Marg, Sion, Mumbai - 400 022.

Tel: +91 22 2084 0325, 7226, 7228, 7229 | Fax : +91 22 2403 8717 | E-mail : principal@pvppcoe.ac.in | Web: www.pvppcoe.ac.in

Founder :  
Late MANOHAR PHALKE  
M.L.C.

President :  
Shri. NANDKUMAR M. KATKAR

General Secretary :  
Adv. APPASAHEB S. DESAI

Treasurer :  
Adv. PRALHAD G. DESAI

Campus Director :  
Prof. ASHOK CHAVAN

Principal :  
Dr. ALAM N. SHAIKH

PVPPCOE/Office/2021-22

Date: 09/11/2021

To

Prof. K. S. Khamkar,  
Assistant Professor  
RD's, S.C.S.C.O.E, Dhangwadi, Pune

Subject-Letter of gratitude..

Dear Madam,

This is an appreciation for conduction of Online **Expert lecture on, "Data structure and algorithm"** dated on 09/11/2021 in our Institute for the student of Computer Engineering.

As per student feedback the session was interesting and beneficial to enhance their knowledge and skills in fait particular subject.

We are thankful for shearing your valuable time and hope you will extend the same cooperation in future also.

Thanking You



Principal

Vasantdada Patil Pratishthan's College of  
Engineering and Visual Arts  
Vasantdada Patil Educational Complex, Eastern  
Express Highway, Padmabhushan Vasantdada  
Patil Marg, Sion, Mumbai - 400 022.



CIN : U40109KA1995PLC017806

# ATHANI SUGARS LIMITED

Shahuwadi Unit (Lessee of Udaysingrao Gaikwad SSK)

Sonawade - Bambawade, 416 213, Taluka Shahuwadi, District Kolhapur.

- Registered Office : VishnuannaNagar, Post Navaihal 591 234, Taluka Athani, District : Belagavi, Tel. (08339) 280100/1/2, Fax : (08339) 280103  
E-mail : info@athanisugars.com, Website : www.athanisugars.com
- Branch Office : 'Shiv Pavilion', Second Floor, Near Ram Mandir, Sangli Miraj Road, Sangli - 416 416. Tel: (0233 - 2373885)



Ref: - ASL/Engg/2021-22/ 55/

Date :-02/02/2022

## CERTIFICATE

"TO WHOM SO EVER IT MY CONCERN"

This is to certificate that Mr. :- Prathamesh Sanjay Khot. He had completed vocational training in our organization from "1<sup>th</sup> November 2021 to 31<sup>th</sup> January 2022. We found he is sincere, hard working and obedient during his training period. We take this opportunity to wish him all the best in his future career.

This certificate is issued on his specific request.

Chief Engineer

Athani Sugars Ltd, Shahuwadi Unit Kolhapur





SHRI PANDURANG PRATISHTHAN PANDHARPUR,  
**KARMAYOGI INSTITUTE OF TECHNOLOGY**

GAT No. 124, 125, AT POST SHELVE, PANDHARPUR, MAHARASHTRA INDIA - 413304  
(APPROVED BY ARCTE, NEW DELHI, RECOGNIZED BY GOVT. OF MAHARASHTRA  
AND AFFILIATED DR. BABASAHEB AMBEDKAR TECHNOLOGICAL UNIVERSITY, LONERE)  
www.karmayogiinstitute.ac.in

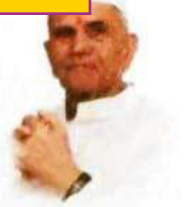

✉ principalkec6326@gmail.com  
☎ +91 8554006300

INSTITUTE CODE 6326

Ref. No. KEC/Admin/2021-22/ 1103

Date: - 21/10/2021

To,  
Prof. B. D. Thorat,  
Assistant Professor,  
Dept. of Computer Engineering,  
RD's, SCSCOE, Dhangwadi, Pune

**Subject:** - Letter of gratitude....

Dear Sir,

This is an appreciation for your valuable time and interest in conduction of online Expert Lecture on, "Machine learning" on 19/10/2021 in our Institute. Around 69 students from Computer Engineering stream were present for valuable session. As per student feedback the session was beneficial to enhance their knowledge and skills in this particular area

We are thankful for sharing your valuable time for our students and hope you will extend the same cooperation in future also

Thanking you

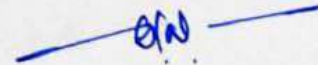

  
Principal



SHRI PANDURANG PRATISHTHAN PANDHARPUR,  
**KARMAYOGI INSTITUTE OF TECHNOLOGY**

GAT No. 124, 125, AT POST SHELVE, PANDHARPUR, MAHARASHTRA INDIA - 413304  
 (APPROVED BY AICTE, NEW DELHI, RECOGNIZED BY GOVT. OF MAHARASHTRA  
 AND AFFILIATED DR. BABASAHEB AMBEDKAR TECHNOLOGICAL UNIVERSITY, LONERE.)

www.karmayoginstitute.ac.in



✉ principalkec6326@gmail.com  
 ☎ +91 8554006300

INSTITUTE CODE 6326

Ref. No. KEC/Admin/2021-22/ 1104

Date: - 13/10/2021

To,

Prof. S. K. Pawar,  
 Associate Professor,  
 Dept. of Mechanical Engineering,  
 RD's, SCSCOE, Dhangwadi, Pune

**Subject:** - Letter of gratitude....

Dear Sir,

This is an appreciation for your valuable time and interest in conduction of online Expert Lecture on, "Thermal analysis of Steam Power Plant" on 13/10/2021 in our Institute. Around 69 students from Mechanical Engineering stream were present for valuable session. As per student feedback the session was beneficial to enhance their knowledge and skills in this particular area

We are thankful for sharing your valuable time for our students and hope you will extend the same cooperation in future also

Thanking you



*S.K.*  
 Principal



# RIYA ENGINEERS



Regd. Off : Plot No. 14, Sneha Vihar, Sangam Nagar, Near National School, Old Sangavi,  
Pune - 411027. Cell : +91 9923092636 Email : rlyaengineers07@yahoo.co.in  
Works : Plot No. 160, Sector No. 10, PCNTDA, Bhosari, Pune - 411026.

## CERTIFICATE

This is to certify that **MR. YADAV KARAN SHANKAR** student of Rajgad Dnyanpeeth's Technical Campus, Dhangawadi. Permanent Registration Number - **72033305K** has successfully completed his **internship** in our organization from 10 OCT 2021 to 20 NOV 2021. During academic year 2021-2022, as partial fulfilment of the Degree (Mechanical Engineering) course.

For Riya Engineers

Proprietor Sign







# RIYA ENGINEERS

Regd. Off : Plot No. 14, Sneha Vihar, Sangam Nagar, Near National School, Old Sangavi,  
Pune - 411027. Cell : +91 9923092636 Email : riyengineers07@yahoo.co.in  
Works : Plot No. 160, Sector No. 10, PCNTDA, Bhosari, Pune - 411026.

## CERTIFICATE

This is to certify that **MR. DHAME SHRINIVAS BALASO** student of Rajgad Dnyanpeeth's Technical Campus, Dhangawadi. Permanent Registration Number -72033250J has successfully completed his internship in our organization from 10 OCT 2021 to 20 NOV 2021. During academic year 2021-2022, as partial fulfilment of the Degree (Mechanical Engineering) course.

For Riya Engineers

Proprietor Sign





# RIYA ENGINEERS

Regd. Off : Plot No. 14, Sneha Vihar, Sangam Nagar, Near National School, Old Sangavi,  
Pune - 411027. Call : +91 9923092636 Email : ryaengineers07@yahoo.co.in  
Works : Plot No. 160, Sector No. 10, PCNTDA, Bhosari, Pune - 411026.

## CERTIFICATE

This is to certify that **MR. DABHOLKAR ATHARVA GURUPRASAD** student of Rajgad Dnyanpeeth's Technical Campus, Dhangawadi. Permanent Registration Number -72033246L has successfully completed his **internship** in our organization from 10 OCT 2021 to 20 NOV 2021. During academic year 2021-2022, as partial fulfilment of the Degree (Mechanical Engineering) course.

For Riya Engineers

  
Proprietor Sign





# RIYA ENGINEERS

Regd. Off : Plot No. 14, Sneha Vihar, Sangam Nagar, Near National School, Old Sangavi,  
Pune - 411027. Cell : +91 9923092636 Email : ryaengineers07@yahoo.co.in  
Works : Plot No. 160, Sector No. 10, PCNTDA, Bhosari, Pune - 411026.

## CERTIFICATE

This is to certify that **MR. KINDRE ROHIT ANIL** student of Rajgad Dnyanpeeth's Technical Campus, Dhangawadi. Permanent Registration Number - 72033268M has successfully completed his **internship** in our organization from 10 OCT 2021 to 20 NOV 2021. During academic year 2021-2022, as partial fulfilment of the Degree (Mechanical Engineering) course.

For Riya Engineers

Proprietor Sign



115



## SHANKAR ENTERPRISES

119/2, SANTOSH NAGAR, BEHIND SANTOSHI MATA TEMPLE, KATRAJ, PUNE  
- 411 046.

MOBILE NO. - 9730448835.

E-MAIL :- [shankarenterprises7799@gmail.com](mailto:shankarenterprises7799@gmail.com), WEB SITE :- [www.shankarenterprises.net](http://www.shankarenterprises.net)

10<sup>th</sup> March 2022.

### WHOMSOEVER IT MAY CONCERN

This is to certify that Mr. Mane Suhas Mohan from Rajgad Dnyanpeeths Technical Campus Dhangawadi, has successfully completed internship in our organization from 3<sup>rd</sup> October 2021. To 10<sup>th</sup> March 2022. The study of his internship was Industrial Training.

For Shankar Enterprises,

**M/s. Shankar Enterprises**

Ashutosh Kadam.

Proprieter. Proprietor





## SHANKAR ENTERPRISES

119/2, SANTOSH NAGAR, BEHIND SANTOSHI MATA TEMPLE, KATRAJ, PUNE  
- 411 046.

MOBILE NO. - 9730448835.

E-MAIL :- [shankarenterprises7799@gmail.com](mailto:shankarenterprises7799@gmail.com), WEB SITE :- [www.shankarenterprises.net](http://www.shankarenterprises.net)

10<sup>th</sup> March 2022.

### WHOMSOEVER IT MAY CONCERN

This is to certify that Mr. Naik Sachin Mohan from Rajgad Dnyanpeeths Technical Campus Dhangawadi, has successfully completed internship in our organization from 3<sup>rd</sup> October 2021. To 10<sup>th</sup> March 2022. The study of his internship was Industrial Training.

For Shankar Enterprises,

*Ashu*

**M/s. Shankar Enterprises**

Ashutosh Kadam.

Proprieter. **Proprietor**





## SHANKAR ENTERPRISES

119/2, SANTOSH NAGAR, BEHIND SANTOSHI MATA TEMPLE, KATRAJ, PUNE  
- 411 046.

MOBILE NO. - 9730448835.

E-MAIL :- [shankarenterprises7799@gmail.com](mailto:shankarenterprises7799@gmail.com), WEB SITE :- [www.shankarenterprises.net](http://www.shankarenterprises.net)

10<sup>th</sup> March 2022.

### WHOMSOEVER IT MAY CONCERN

This is to certify that Mr. Waghmare Somnath Sudam from Rajgad Dnyanpeeths Technical Campus Dhangawadi, has successfully completed internship in our organization from 3<sup>rd</sup> October 2021. To 10<sup>th</sup> March 2022. The study of his internship was Industrial Training.

For Shankar Enterprises,

Ms. Shankar Enterprises

Ashutosh Kadam.

Proprieter. Proprieto,





# VASANTDADA PATIL PRATISHTHAN **116** COLLEGE OF ENGINEERING AND VISUAL ARTS

(Formerly Known as Padmabhushan Vasantdada Patil Pratishthan's College of Engineering)

TRUST REGD. NO. F. 6736 (MUMBAI)

NAAC ACCREDITATION FOR 5 YEARS : (28.03.2019 to 27.03.2024)

NBA ACCREDITED COURSES : (During 15.03.2012 to 14.03.2015) COMP. ENGG./ ELEX. ENGG. / EXTC. ENGG./ I.T.  
(F.No 28-110 / 2010 - NBA Dated 02/04/2012)

Office : Vasantdada Patil Educational Complex, Eastern Express Highway, Padmabhushan Vasantdada Patil Marg, Sion, Mumbai - 400 022.

Tel: +91 22 2084 0325, 7226, 7228, 7229 | Fax : +91 22 2403 8717 | E-mail : principal@pvppcoe.ac.in | Web: www.pvppcoe.ac.in

Founder:  
Late MANOHAR PHALKE  
M.L.C.

President:  
Shri. NANDKUMAR M. KATKAR

General Secretary:  
Adv. APPASAHEB S. DESAI

Treasurer:  
Adv. PRALHAD G. DESAI

Campus Director:  
Prof. ASHOK CHAVAN

Principal:  
Dr. ALAM N. SHAIKH

PVPPCOE/Office/2021-22

Date: 13/09/2021

To

Prof. Mrs. S. I. Nipanikar,  
Assistant Professor  
RD's, S.C.S.C.O.E, Dhangwadi, Pune

Subject-Letter of gratitude...

Dear Madam,

This is an appreciation for conduction of Online **Expert lecture on, "Microstrip Antenna Design and Applications"** dated on 13/09/2021 in our Institute for the student of Electronic & Telecommunication Engineering.

As per student feedback the session was interesting and beneficial to enhance their knowledge and skills in fait particular subject.

We are thankful for shearing your valuable time and hope you will extend the same cooperation in future also.

Thanking You



Principal

Vasantdada Patil Pratishthan's College of  
Engineering and Visual Arts  
Vasantdada Patil Educational Complex, Eastern  
Express Highway, Padmabhushan Vasantdada  
Patil Marg, Sion, Mumbai - 400 022.



**Soft Solution Pvt. Ltd**

SIMPLE SOLUTION FOR COMPLEX CONNECTIONS



Sunday, October 24, 2021

## CERTIFICATE OF SPONSORSHIP

To Whom It May Concern

This is to certify that following students of RDTC's SCSCOE ,PUNE are developing an Online Assessment And Proctoring System For Candidates Recruitment At Workplaces their Final Year Project This respective Project of theirs is being Sponsored by Gsoft Solution Pvt.Ltd .

- |                               |               |
|-------------------------------|---------------|
| 1. Ankita Vijay Dhamal        | +917057085979 |
| 2. Priyanka Rohidas Parkhande | +919405374992 |
| 3. Vinayak Shankar Dighe      | +919284427636 |
| 4. Rushikesh Ramdas Galkwad   | +917028502975 |

This certification is being issued upon his/her /their request for whatever purpose it may serve.



+919049361265



104, G Soft Solutions Pvt. Ltd.  
Mumbai Bangalore Highway, Dangat Park, Warje, Pune 58





**RIETER**

ARIP/HR&ADMIN/2021  
Wing, Date: 07.10.2021

**CERTIFICATE**

**TO WHOMSOEVER IT MAY CONCERN**

This is to certify that, Mr. Aniket Sanjay Jadhav, student of Shri. Chhatrapati Shivaji Raje College of Engineering, Pune affiliated with Savitribai Phule Pune University, studied in the Third Year of Mechanical Engineering has successfully completed his training in Industrial Engineering department under the projects work entitled "Assembly Process Layout review" in our organization during the period from 06.09.2021 to 06.10.2021

During the above training period, he was found to be obedient, punctual, sincere and hardworking. He has leadership qualities and found to be able communicator. He was found to take initiative and concerned for organizational growth. He can contribute effectively in team.

We wish him all the best in his future endeavors.

**For Rieter India Private Limited.**

**Monali Ringe**  
Sr Manager – HR Excellence



119

# PROJECT SPONSORSHIP LETTER



Ki Sevan is Prerogya Mitai Surt

## K-STAR PLASTIC INDUSTRIES

Manufacturer of Plastic Injection Moulding Products

Gat No. 124/1, A/P. Mirje, Mirje - Jawale Road, Near Shirwal M.I.D.C., Tal. Khandala, Dist. Satara-412 801 (Maharashtra)

M kstarplastics@gmail.com ☎ 9423061675 ☎ 9922067778 GSTIN : 27AHQPK8928A122

Ref. No. :

Date : 03/11/2021

To,  
Rajgad Dnyanpeeth's Shri Chhatrapati Shivajiraje College of Engineering  
Dhangawadi, Tal. Bhor, Dist.- Pune.  
Pin- 412206

Subject : About giving project Sponsorship

To Whom It May Concern,

**Name of Students:**

1. Yadav Omkar Ramchandra
2. Bondade Ajay Rajendra
3. Shinde Shivraj Haribhau
4. Damakle Avdhut Anil

Sponsor Name : K Star Plastic Industries.

I Agree to give Sponsorship for the above named students at University of Pune, Rajgad Dnyanpeeth's Shri Chhatrapati Shivajiraje College of Engineering Dhangawadi. This Students Working on Project Titled "Mild Steel Wall Climbing Robot".

This Sponsorship includes tuition & hands on work two days a Week as per Request.

Sincerely,



Abhishek Kadam

(Managing Director)



# श्री राधाकृष्ण सिमेंट पाईप्स अँड प्रॉडक्टस्

बँक ऑफ महाराष्ट्रचे पाठीमागे, शिंगणापुर रोड, कोळकी, ता. फलटण, जि. सातारा

प्रो.प्रा. : श्री. नितिन जी. केजले

मो. : ८६६९०९८३४०

Date - 25/08/2021

## SPONSERSHIP LETTER

To,  
The Principal,  
Rajgad Dnyanpeeths Shri Chhatrapati Shivajiraje College of Engineering, Bhor  
PIN-412206

**Subject - Offering sponsorship to the project work**

Respected sir,

This correspondence is issued as per requirement of following of your college,

- 1) Mr. Shubham M. Bobade
- 2) Mr. Omkar T. Korade
- 3) Mr. Akshay S. Bhilare
- 4) Mr. Satyam A. Eratkar

Above students interested in work with us regarding site work, our firm sponsoring the project-Casting of bricks using plastic waste and construction waste material, the concept of project helps us to implement the major brick works.

We are providing all technical data and guidance of experts for required project work. This Bricks are used for various purposes like pavement, footpath, wall, retaining wall. The cost incurred for the project will be borne by our company and looks forward for successful completion of the project.

**DIRECTOR**  
Mr. Nitin G. Kenjale



दर्जेदार सिमेंट प्रॉडक्टस्चे उत्पादक

Date : 20 Sept. 2021

121

TO WHOM SO EVER IT MAY CONCERN

This is to certify that **Mr. Tejas Tanaji Dudhane** had been In the Internship with **VCB Electronics Private Limited** From **19 Aug. 2021 to 19 Sept. 2021.**

We found him sincere, hardworking, technically sound and result oriented during his tenure

We wish him success in his future endeavors.

For VCB Electronics Private Limited

*B.S. Bhosale*

B.S. Bhosale  
(Director)



**VCB Electronics Pvt. Ltd.**

Gat No. 760, Khed Shivapur, Tal.: Haveli, Dist.: Pune - 412205.

Phone : +91 20 66702000 E-mail : vcbmarketing@vcbelec.com, vcbpurchase@vcbelec.com

Date: 22-01-2022

## SPONSORSHIP LETTER

I S A SHETH a Civil Engineering Construction Company established in the year 1997.  
The Firm has executed many numbers of Projects with Government Organization PWD, CIDCO, MIDC, MMRDA, RCF, and Private works etc. all over Maharashtra.

I write to confirm that

1. Mr. Pravin Prakash Pawar
2. Mr. Rohit Ramakantrao Kulkarni
3. Mr. Ajay Nivruti Gujalwad
4. Miss. Rutuja Nandkumar Barge are in receipt of official sponsorship from us on below Terms & Conditions.

Academic Project Work: - Detailed Project Report of Roadwork 2.5km length

1. Providing required Surveying Equipment's with LXQ-CAD Software
2. Financial Sponsorship of Rs 5000/-
3. Kindly submit official letter of Institute

With Best Regards,

S. A. SHETH, THANE



123

# MICROVERSION TECHNOLOGIES

## CERTIFICATE OF SPONSORSHIP

To Whom It May Concern:

This is to certify that following **students of SCSCOE, Pune** are developing an WebBased Detection System for Diabetic Retinopathy titled "**DETECTDR – CLASSIFICATION OF DIABETIC RETINOPATHY USING FRACTAL ANALYSIS AND RANDOM FOREST**" as their Final Year Project. This respective project of theirs is being **sponsored by MicroVersion Technologies.**

1. YADAV POONAM R
2. MALUSARE KAJAL S
3. YADAV REVATI V
4. PAWAR SNEHA S

This certification is being issued upon his/her/their request for whatever purpose it may serve.

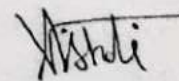

**MicroVersion Technologies**



## SPONSORSHIP LETTER

Date: 16 Dec. 21

To,  
The Principal,  
Rajgad Dnyanpeeth's  
Shree Chhatrapati Shivajiraje College of Engineering, Pune.

**Subject: Offering Sponsorship to the Student of BE (Comp).**

Dear Sir,

We would like to hereby confirm you, that **Miss. Namita Prafulla Hingmire, Miss. Namrata Rohidas Bhargude, Miss. Pratiksha Dattatray Mane and Miss. Samruddhi Santosh Hagawane** are the students of BE., from your college who have been selected for carrying out the Final Year Project "**Automatic Image Tagging using Machine Learning**" They will work with our organization, **Mythos Technology** from 01/08/2021 for exactly 6 months.

The working schedule of their project will be 2 days a week from 11.00 am to 02.00 pm.

The details and scope of this project will be provided to them from the beginning of their tenure at the company facility. Upon successful completion of the project, they will be issued a certificate. We will be required to submit a copy of the detailed report before completion of the project with a sample model which is required to be submitted at the time of external examination held at the college.

Thanks & Regards,

Authorized Sign

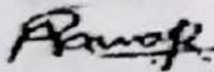

Abhay Pawar  
Manager, Mythos Technology,  
Narhe, Pune-41.



Address - SR.No 50/16, Narhe road, Navle Hospital, Narhe, Pune-411041

020-24393922

## SPONSORSHIP LETTER

Date: 18 Dec. 21

To,  
The Principal,  
Rajgad Dnyanpeeth's  
Shree Chhatrapati Shivajiraje College of Engineering, Pune.

**Subject: Offering Sponsorship to the Student of BE (Comp).**

Dear Sir,

We would like to hereby confirm you, that Miss. Khopade Pratiksha Sonba, Miss. Pujari Gauri Somnath, Miss. Khopade Pratiksha Deepak and Miss. Bardade Shubbada Chandrakant are the students of BE., from your college who have been selected for carrying out the Final Year Project "Precision agriculture for Indian context using Learning Techniques" They will work with our organization, Mythos Technology from 01/08/2021 for exactly 6 months.

The working schedule of their project will be 2 days a week from 11.00 am to 02.00 pm.

The details and scope of this project will be provided to them from the beginning of their tenure at the company facility. Upon successful completion of the project, they will be issued a certificate. We will be required to submit a copy of the detailed report before completion of the project with a sample model which is required to be submitted at the time of external examination held at the college.

Thanks & Regards,  
Authorized Sign

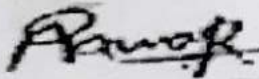

Abhay Pawar  
Manager, Mythos Technology,  
Narhe, Pune-41.





## SPONSORSHIP LETTER

Date: 20 Dec. 21

To,  
The Principal,  
Rajgad Dnyanpeeth's  
Shree Chhatrapati Shivajiraje College of Engineering, Pune.

**Subject: Offering Sponsorship to the Student of BE (Comp).**

Dear Sir,

We would like to hereby confirm you, that **Mr. Dhumal Rohan Satish, Mr. Papal Mahesh Shivaji, Mr. Waghmode Tushar Maharudra and Mr. Shendkar Ketan Dhananjay** are the students of BE., from your college who have been selected for carrying out the Final Year Project "Automatic Face Mask Detection System using Deep Learning" They will work with our organization, **Mythos Technology** from 01/08/2021 for exactly 6 months.

The working schedule of their project will be 2 days a week from 11.00 am to 02.00 pm.

The details and scope of this project will be provided to them from the beginning of their tenure at the company facility. Upon successful completion of the project, they will be issued a certificate. We will be required to submit a copy of the detailed report before completion of the project with a sample model which is required to be submitted at the time of external examination held at the college.

Thanks & Regards,  
Authorized Sign

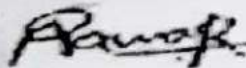

Abhay Pawar  
Manager, Mythos Technology,  
Narhe. Pune-41.





L&D INFOTECH PVT. LTD.  
CONNECTIVITY WITH WORLD  
**LOMTE & DARADE INFOTECH PVT.LTD**

Date: 20/07/2021

To,  
The Principal,  
Rajgad Dnyanpeeth's  
Shri chhatrapati shivajiraje college of engineering  
Pune

**Subject:- Internship/Sponsorship Letter**

Respected Sir/Madam,

We would like to hereby confirm you, that **Ubhe Rutvik Baban, Rathod Bhimrao Devidas Chikane Payal Bharat** are students of Fourth Year Degree in Computer Engineering from your college who have been selected for carrying out the Final Year Project "Text mining from the web for medical intelligence ". They will work with our organization from 01/08/ 2021 to 15/02/2022.

The working schedule of their project will be 2 days a week from 11.00 am to 6.00 pm. The details and scope of this project will be provided to them from the beginning of their tenure at the company facility. Upon successful completion of the project, they will be issued a certificate. We will be required to submit a copy of the detailed report before completion of the project.

Congratulations and welcome to the team!

Thanks & Warm Regards,

Somnath Lomate  
(Director)  
L & D Infotech Private Limited



🌐 [www.Indinfotech.co.in](http://www.Indinfotech.co.in)    📘 [www.facebook.com/LDI2019](https://www.facebook.com/LDI2019)    ✉ [Info@Indinfotech.co.in](mailto:Info@Indinfotech.co.in)

📍 Flat No. OP 302, Meghmalhar,  
G.No 87 to 90,PH -II,DSK Vishwa ,Pune-41.    ☎ 7887809708/ 8830274518



128



# Swara Enterprises

Shop No.02, Amrutvel Complex, Nachane Road  
Ratnagiri, 415612

Mobile 9922948572

Email: swaraenterprisesrtn@gmail.com

Ref: SE/SPN/112/2022

Date: 20/05/2022

## SPONSORSHIP LETTER

To,  
The Principal  
Rajgad Dnyanpeeth's Chhatrapati Shivajiraje College of Engineering,  
Dhangwadi, Borhore, Pune  
PIN Code -412206

### Subject: Offering Sponsorship to the project work

Respected Sir,

This correspondence is issued as per requirement of following of your college,

1. Kazi Arshad Nazir
2. Mandhare Prajakta Prakash
3. Shaikh Tabasum Firoj

Above students interested to work with us regarding a project assigned to our company, thus we are sponsoring their project-**Cow Health Monitoring System using IoT.**

We are providing financial support to complete this project, as well as technical data & Expert guidance required for this project work. This project is useful for the farmers to take care of their animal as well as to monitor their health from distance. We are looking forward for completion of the project.

*Nalage*  
DIRECTOR

Mrs. Sandhya S. Nalage

Swara Enterprises  
Prop. Mrs. Sandhya S. Nalage  
Shop No. 02, Amrutvel Complex,  
Ratnagiri - 415 612  
M. 9922948572 / 9511760259





Swara Enterprises

129

Shop No.02,Amrutvel Complex,Nachane Road  
Ratnagiri,415612

Mobile 9922948572

Email:swaraenterprisesrtn@gmail.com

Ref: SE/SPN/113/2022

Date: 20/05/2022

SPONSORSHIP LETTER

To,  
The Principal  
Rajgad Dnyanpeeth's Chhatrapati Shivajiraje College of Engineering,  
Dhangwadi,Bhor Pune  
PIN Code -412206

**Subject: Offering Sponsorship to the project work**

Respected Sir,

This correspondence is issued as per requirement of following of your college,

1. Bankar Hrishikesh Ramesh
2. Chavan Aishwarya R.
3. Chavan Ankita Prakash

Above students interested to work with us regarding a project assigned to our company, thus we are sponsoring their project- **Face Mask &body Temperature Detection using Arduino Uno**

We are providing financial support to complete this project, as well as technical data & Expert guidance required for this project work. This project is useful for the for the industry owners to monitor body temperature of their workers and to check the face mask. We are looking forward for completion of the project.

*Nalage*  
DIRECTOR

Mrs.Sandhya S.Nalage

Swara Enterprises

Prop. Mrs. Sandhya S. Nalage  
Shop No. 02, Amrutvel Complex,  
Ratnagiri - 415 612  
1.9922948572 / 9511760259





Swara Enterprises

130

Shop No.02, Amrutvel Complex, Nachane Road  
Ratnagiri, 415612

Mobile 9922948572

Email: swaraenterprisesrtn@gmail.com

Ref: SE/SPN/113/2022

Date: 20/05/2022

SPONSORSHIP LETTER

To,  
The Principal  
Rajgad Dnyanpeeth's Chhatrapati Shivajiraje College of Engineering,  
Dhangwadi, Bhore Pune  
PIN Code -412206

**Subject: Offering Sponsorship to the project work**

Respected Sir,

This correspondence is issued as per requirement of following of your college,

- i. Bhosale Rajshri Sunil
- ii. More Varsharani R.
- iii. Pilane Akshada Balu

Above students interested to work with us regarding a project assigned to our company, thus we are sponsoring their project- **Intelligent Exam Paper Leakage Detection**

We are providing financial support to complete this project, as well as technical data & Expert guidance required for this project work. This project is useful for the Educational Institutes. We are looking forward for completion of the project.

*Nalage*

**DIRECTOR**

Mrs. Sandhya S. Nalage

Swara Enterprises  
Prop. Mrs. Sandhya S. Nalage  
Shop No. 02, Amrutvel Complex,  
Ratnagiri - 415 612  
+91 9922948572 / 9511760259





Swara Enterprises

131

Shop No.02, Amrutvel Complex, Nachane Road  
Ratnagiri, 415612

Mobile 9922948572

Email: swaraenterprisesrtn@gmail.com

Ref: SE/SPN/115/2022

Date: 20/05/2022

**SPONSORSHIP LETTER**

To,

The Principal

Rajgad Dnyanpeeth's Chhatrapati Shivajiraje College of Engineering,

Dhangwadi, Bhor Pune

PIN Code -412206

**Subject: Offering Sponsorship to the project work**

Respected Sir,

This correspondence is issued as per requirement of following of your college,

- i. Gaikwad Pooja
- ii. Kanade Payal
- iii. Kazi Mansur

Above students interested to work with us regarding a project assigned to our company, thus we are sponsoring their project- **IoT Based EV's Battery Swapping & Charging system using Solar**

We are providing financial support to complete this project, as well as technical data & Expert guidance required for this project work. This project is useful EV owners as well as manufacturer. We are looking forward for completion of the project.

*Nalage*

**DIRECTOR**

Mrs. Sandhya S. Nalage

**Swara Enterprises**

Prop. Mrs. Sandhya S. Nalage  
Shop No. 02, Amrutvel Complex,  
Ratnagiri - 415 612

1. 9922948572 / 9511760259



132



ISO 9001:2008



Date : 25.05.2022

To,

Rajgad Dnyanpeeth

Shri Chhatrapati Shivajiraje College of Engineering, Dhangawadi , Bhor

Pune 412206

Subject: About giving Project Sponsorship To

Below Mention Students

Name of Students :

1.Taru Vaibhav Anil 2.Raut Vijay Balu

3.Chaudhari Rupesh Tanaji 4.Chavan Aniket Chanandrakant

Sponsor Name :

I Agree to give Sponsorship for above students of Pune University at Shri Chhatrapati Shivajiraje College of Engineering Dhangawadi, Bhor. These Student Working on Project Titled 'Design & manufacturing of Cam Operated Multiple Hammering Machine'. This Sponsorship includes tution & hands on work two days a week as per Request

For Shree Dhananjay Electricals  
Authorized Signatory



Plot No. W-76, Additional MIDC (Kodoli), Satara  
Ph: 02162-240605 | M: 9422033769, 8888241731 | info@sdelectricals.co.in

## PRANAV CONSTRUCTION

**Add:** At Post Shirwal, Tal – Khandala, Dis- Satara, 412801.

**Contact:** +91 9373930707 / 9552296317

**Email id:** - [pranavconstruction07@gmail.com](mailto:pranavconstruction07@gmail.com)

All types of Industrial Solutions.

### SPONSORSHIP LETTER

To,

**The Principal,**

Rajgad Dnyanpeeth's Shri Chhatrapati Shivajiraje College Of Engineering, Bhor  
PIN-- 412206

**Subject: - Offering Sponsorship to the Project work.**

Respected Sir,

This correspondence is issued as per requirement of following of your college,

- 1) Mr. Nikhil A. Khopade
- 2) Mr. Pritesh N. Thopate
- 3) Mr. Rushikesh K. Bhosale
- 4) Mr. Ritesh V. Kumbharkar

Above students interested on work with us regarding site work, our firm sponsoring the project -- **STUDY OF REUTILIZATION OF PLASTIC AND CERAMIC WASTE PAVER BLOCK**", the concept of project helps us to implement the major paver block work.

We are providing all technical data and guidance of experts for required project work. This Blocks are used for various purposes like pavement, footpath, garden walkway. The cost incurred for the project will be borne by our company and looks forward for successful completion of the project.

**Owner**

**Pranav Construction Kesurdi.**

**Pranav Construction**  
**Proprietor**  
Stamp

GST NO:- 27BZRPB3125Q12W





# ANANT DUDH PVT. LTD.

134

Dairy :

Gat No. 268/269, A/p - Kikavi, Tal. Bhor, Dist. Pune Pin 412 206  
Mob. 9822063299 E-mail ID : anant\_dudh@yahoo.co.in

Ref. ADPL/KKV/136/2022

Date: 23/05/2022

## SPONSORSHIP LETTER

To,

The Principal,

Rajgad Dnyanpeeth's Shree Chhatrapati Shivajiraje College of Engineering,

Dhangawadi, Bhor Pune.

PIN Code-412206.

**Subject - Offering Sponsorship to the project work**

Respected Sir,

This correspondence is issued as per requirement of following of your college,

1. Mr. Sushant Sanjay Patil
2. Mr. Karan Rajendra Valkunde
3. Mr. Pruthviraj Shivaji Khambe
4. Mr. Aniket Anandrao Phalke

Above students interested in work with us regarding Dairy Work, our firm sponsoring the project- **Dairy Waste Management In Anant Dudh Dairy**, the concept of project help us to implement the Reverse Osmosis Process at ETP.

We are providing all technical data and guidance of experts for required project work.

This R.O. plant is used for water filtration at ETP. The cost incurred for the project will be borne by our company and looks forward for successful completion of project.

*[Signature]*  
MANAGING DIRECTOR  
ANANT DUDH PVT.LTD





**RAJGAD DNYANPEETH**  
**DNYANPEETH TECHNICAL CAMPUS POLYTECHNIC**  
 S.N.237, DHANGAWADI, TAL-BHOR, DIST- PUNE.

**DEPARTMENT OF E&TC ENGINEERING**  
 Academic Year 2022-23)

RD/RDTCP/GEN/2021-22/104

Date:- 22/03/2022

To,  
 Dr.Sanjay I.Nipanikar.  
 Shri Chhatrapati Shivajiraje College Of Engineering,  
 Pune

**Subject – Appreciation Letter**

Respected Sir,

On behalf of the board of Rajgad Dnyanpeeth Technical campus Polytechnic, it is my pleasure to thank you for your co-operation. Our E&TC students are very much impressed by your Guest Lecture under subject of Basic Power Electronic on the date of 23<sup>th</sup> MAR 2022 at 2.00 pm.

Thank you for sharing your experience so freely. Your guidance will be definitely beneficial to our students in their career.

Thank You once again.

Yours faithfully

Prof. Khopade D. K.

**Principal**

Rajgad Dnyanpeeth Technical Campus Polytechnic  
 Dhangawadi, Tal. Bhor, Dist. Pune





RAJGAD DNYANPEETH  
DNYANPEETH TECHNICAL CAMPUS POLYTECHNIC  
S.N.237, DHANGAWADI, TAL-BHOR, DIST- PUNE.

**DEPARTMENT OF E&TC ENGINEERING**  
Academic Year 2022-23)

RD/RDTCP/GEN/2021-22/68

Date:- 09/02/2022

To,  
Dr.Sanjay I.Nipanikar.  
Shri Chhatrapati Shivajiraje College Of Enginnering,  
Pune

**Subject – Appreciation Letter**

Respected Sir,

On behalf of the board of Rajgad Dnyanpeeth Technical campus Polytechnic, it is my pleasure to thank you for your co-operation. Our E&TC students are very much impressed by your Guest Lecture under subject of **Embedded System** on the date of 09<sup>th</sup> FEB 2022 at 3.00 pm.

Thank you for sharing your experience so freely. Your guidance will be definitely beneficial to our students in their career.

Thank You once again.

Yours faithfully

Prof. Khopade D. K.



**Principal**  
Rajgad Dnyanpeeth Technical Campus Polytechnic  
Dhangawadi Tal. Bhor, Dist.Pune

(सवि. नं. पी.एच.ए. (बी.एच.आर.)पी.आर.जी.(ए) - १० (एस) ०८-०३ / दिनांक : २०/१०/१९८८  
स्थापना : विजयादशमी १९८८

अनंतराव शोपटे  
(मा. मंत्री महाराष्ट्र राज्य)  
संस्थापक -संचालक

संग्रामदादा शोपटे  
चेअरमन (अध्यक्ष)



**राजगाड**

सहकारी साखर कारखाना लि.,  
अंतर्गत - विणडे, ता. भोर, जि. पुणे - ४१२२०५  
फोन नं. : (०२११३) २०२२०२, २०२२०४  
मोबा नं. : ९८५०६२८८३६/९९२२४१४२३९  
फॅक्स : (०२११३) २८२४०५  
तार : राजगुड भोर  
ईमेल : rajgadsugar\_bhor@rediffmail.com  
rajgadsugarbhor@gmail.com

## *Certificate of Internship*

### To whomsoever and concern

This is certified that

Mr Borkar Pravin Dadasaheb

Mr. Devkar Kewal Yuvraj

Mr. Dhaigude Sagar Ramesh

Mr. Jadhav Kiran Rajaram

Of

Shri Chhatrapati Shivajiraje College of Engineering, Dhangwadi, Tal- Bhor, Dist- Pune.

Branch Mechanical Engineering has successfully completed Internship in our company from 1/10/2021 to 31/10/2021.

During program the nature and work of above students is satisfactory.





# ANANT DUDH PVT LTD.

DAIRY

Gat No. 263 A/c. Kikavi Tal. Bhor, Dist. Pune, Pin - 412206.  
 Tele Fax No. (02113) 282383. Phone - 202242 - E-mail-anant\_dudh@yahoo.co.in  
 Website www.anantdudh.tradeindia.com

PUNE OFFICE :- Datta Digambar Sahakar Vahatuk Kamgar Sanstha Ltd. Building, Near Bharati Vidyapeeth Get,  
 Pune - Satara Road, Katraj, Pune - 411046.

## *Certificate of Internship*

### To whomsoever and concern

This is certified that

Mr. Awade Shrikant Sunil  
 Mr. Bhosale Nilam Sanjay  
 Mr. Bhosale Shambhuraj Dattatray  
 Mr. Bobade Avdhut Anil

Of

Shri Chhatrapati Shivajiraje College of Engineering, Dhangwadi, Tal- Bhor, Dist- Pune.

Branch Mechanical Engineering has successfully completed Internship in our company from  
 01/12/2021 to 31/12/2021.

During program the nature and work of above students is satisfactory.

